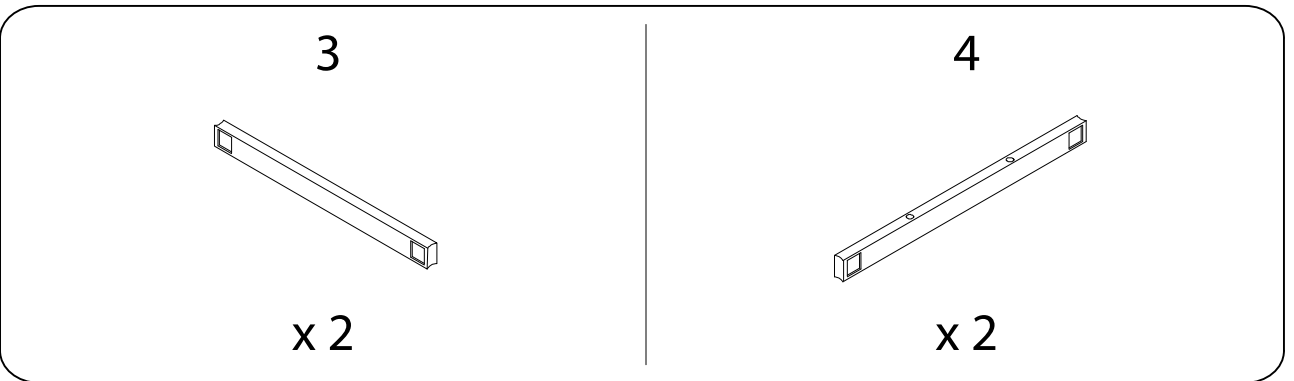
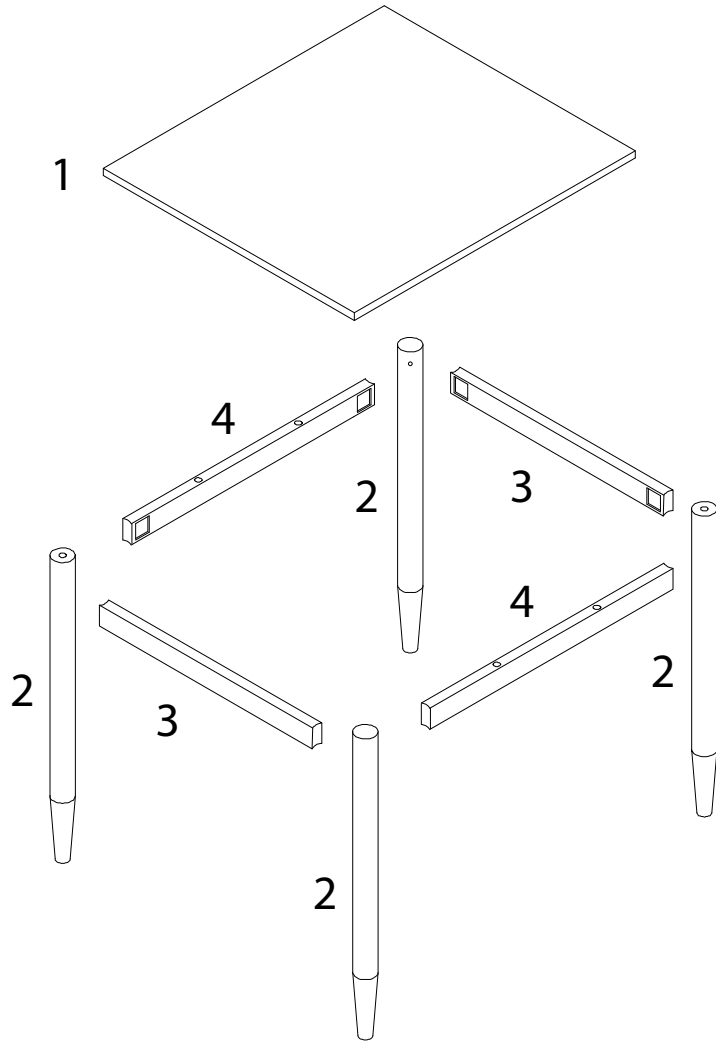
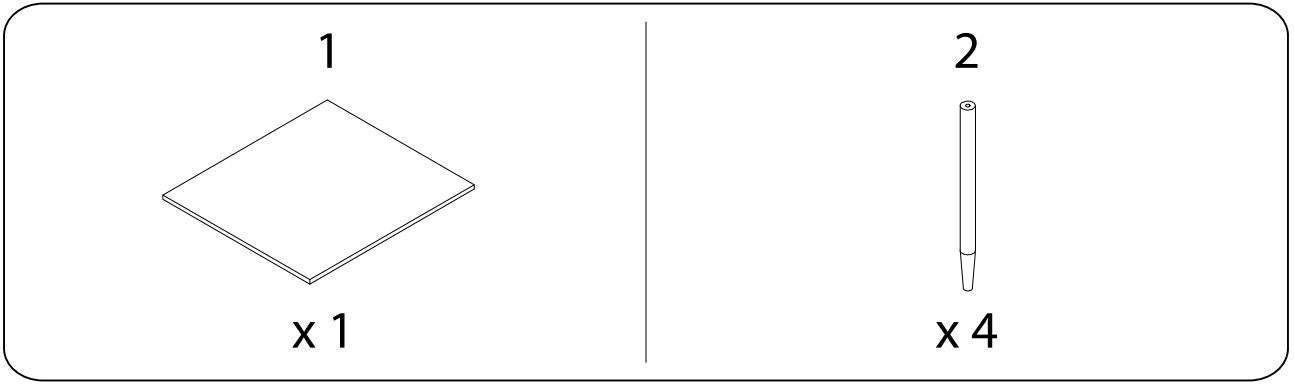
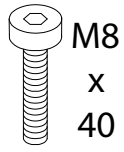

Diagram illustrating assembly instructions and safety warnings:

- Warning 1:** A warning triangle with an exclamation mark is shown next to a box containing an L-shaped metal bracket and a power drill with a slash through it, indicating that a power drill should not be used on this part.
- Warning 2:** A second warning triangle with an exclamation mark is shown next to a box containing a rectangular block being placed on a surface and a diagram of a block being pushed down with a force arrow, indicating a safety warning about weight or force.
- Time:** A clock icon is shown next to the text "20'", indicating a 20-minute assembly time.
- Personnel:** A stick figure icon is shown next to the number "2", indicating that two people are required for assembly.



A



x 4

B

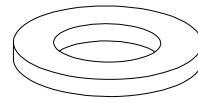

x 4

C

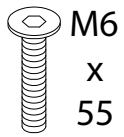

x 4

D

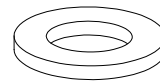

x 4

E

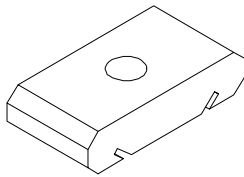

x 4

F

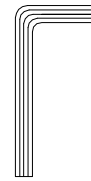

x 1

G

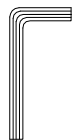





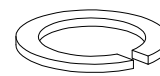

x 1

H



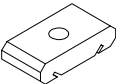

x 4

1

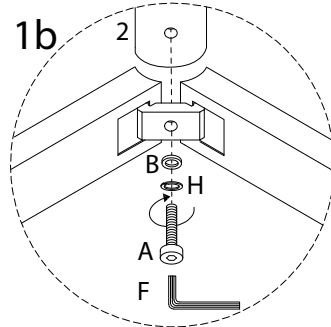
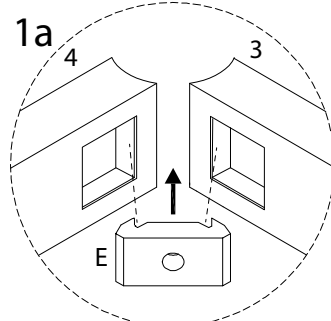
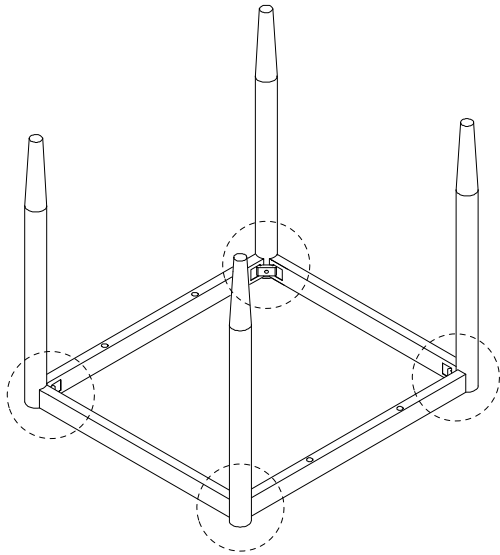
2	3	4	A	B	E	F	H
							
x4	x2	x2	x4	x4	x4	x1	x4

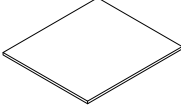

2

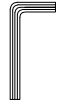
1	C	D	G
			
x1	x4	x4	x1

