

ASSEMBLY INSTRUCTIONS

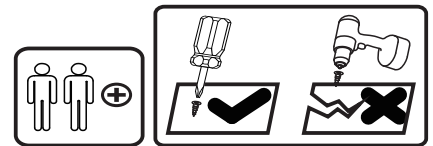
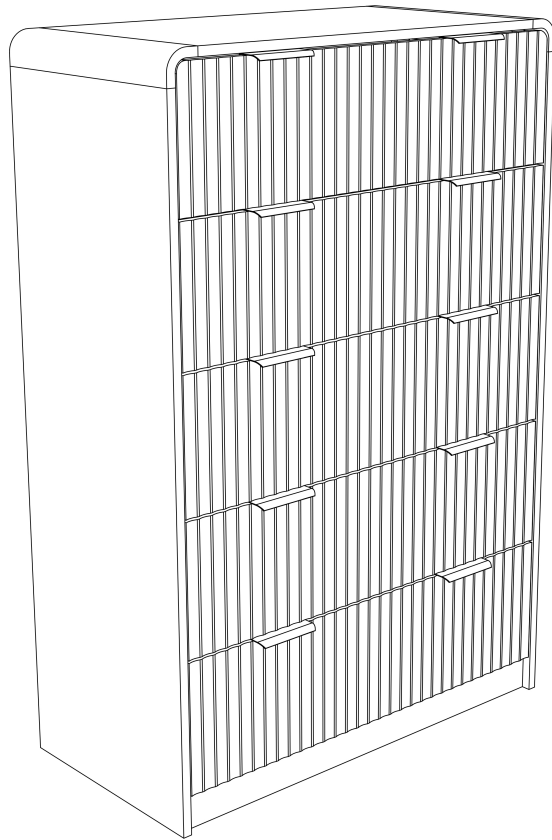

Tools Recommended

THIS INSTRUCTIONS CONTAINS IMPORTANT SAFETY INFORMATION.
PLEASE READ BEFORE ASSEMBLY AND KEEP FOR FUTURE REFERENCE.

Need Parts or Assistance? Email us at support@homejoyee.com

IMPORTANT NOTICE

- This product contains small components, please ensure that they are kept away from small children.
- THIS INSTRUCTIONS CONTAINS IMPORTANT SAFETY INFORMATION. PLEASE READ BEFORE ASSEMBLY AND KEEP FOR FUTURE REFERENCE.
- Read each step carefully. It is very important that each step of instruction is performed in the correct order. If these steps are not followed in sequence, assembly difficulties will occur.
- Make sure all parts are included. Most parts are labelled or stamped on the raw edge.
- Work in spacious area, preferably on a carpet, near the place the unit will be used.
- Do not use power tools to assemble your furniture. Power tools may strip or damage the parts.
- Move your new furniture carefully, with two people lift and carry the unit to it's new location.
- Never push, drag or pull your furniture (especially on carpet)



PLEASE DO NOT RETURN PRODUCT TO US IMMEDIATELY

If a part is missing or damaged, email our customer service. We will gladly ship your replacement parts FREE of charge.

Need Parts or Assistance? Email us at [**support@homejoyee.com**](mailto:support@homejoyee.com)







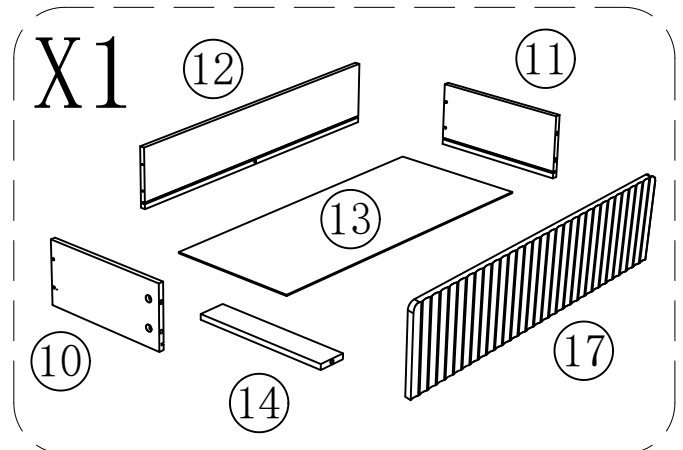
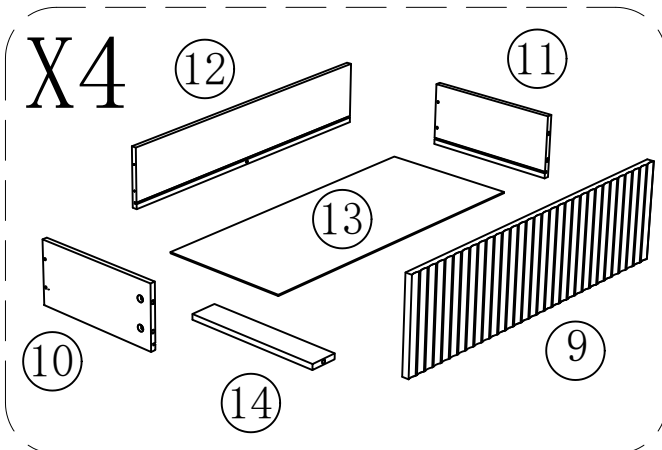
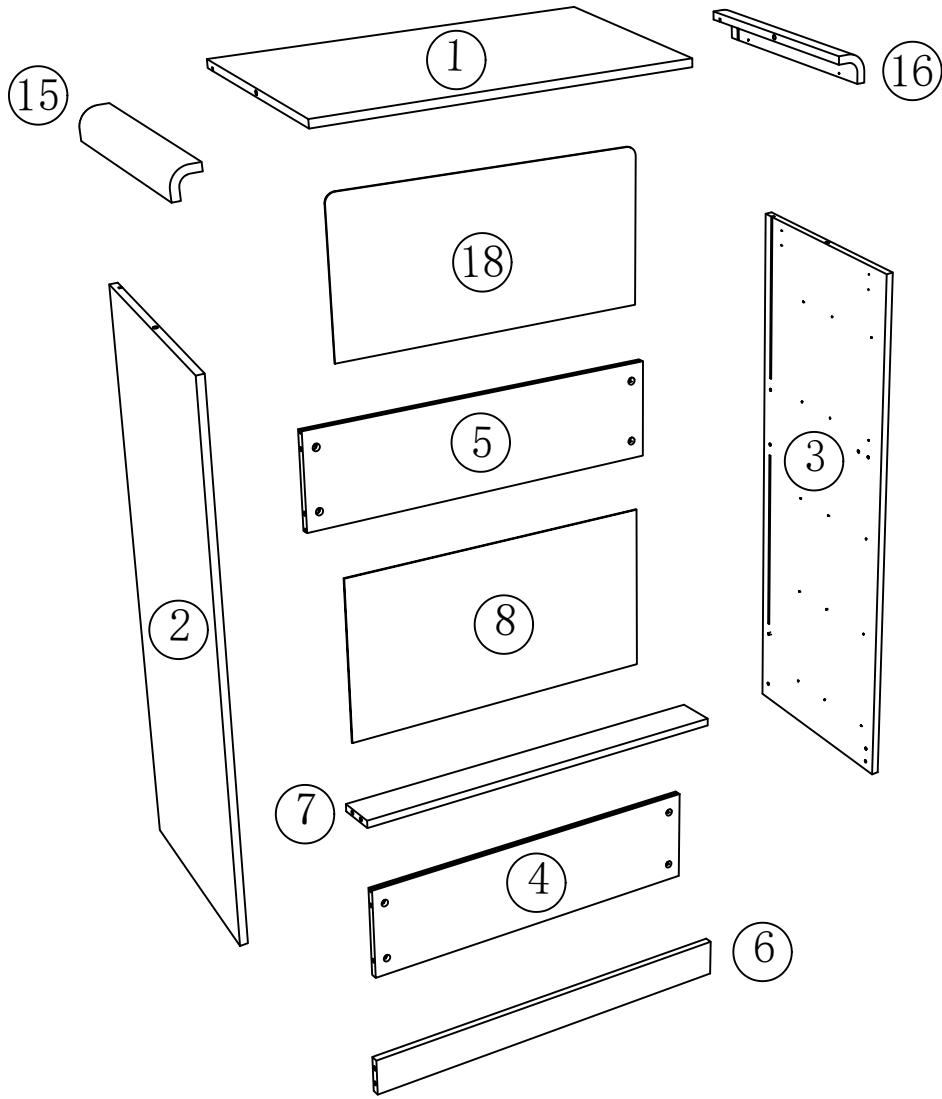



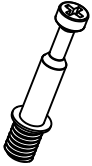

For Prompt, reliable service, please have your assemble instruction ready.

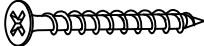
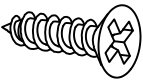
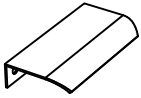
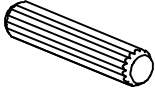
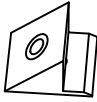
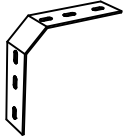
 WARNING	
	<p>Children have died from furniture tipover. To reduce the risk of furniture tipover:</p> <ul style="list-style-type: none">• ALWAYS install tipover restraint provided.• NEVER put a TV on this product.• NEVER allow children to stand, climb or hang on drawers, doors, or shelves.• NEVER open more than one drawer at a time.• Place heaviest items in the lowest drawers.
	

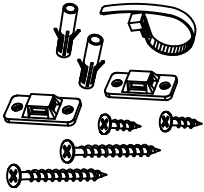

EXPLODED DRAWING



ACCESSORIES LIST

A	X41	B	X16	C	X25	D	X20	E	X25
									
M6X35		ø15X12		ø15X10		M3X12		M4X40	
F	X58	G	X10	H	X4	I	X8	J	X4
									
M3X14				ø8X40					
K	X24	L	X2	M	X1	DR	X5	DL	X5
									
M4X14									
CR	X5	CL	X5						
									

STEP 1

F	X30	CR	X5	CL	X5
					
M3X14		300MM		300MM	

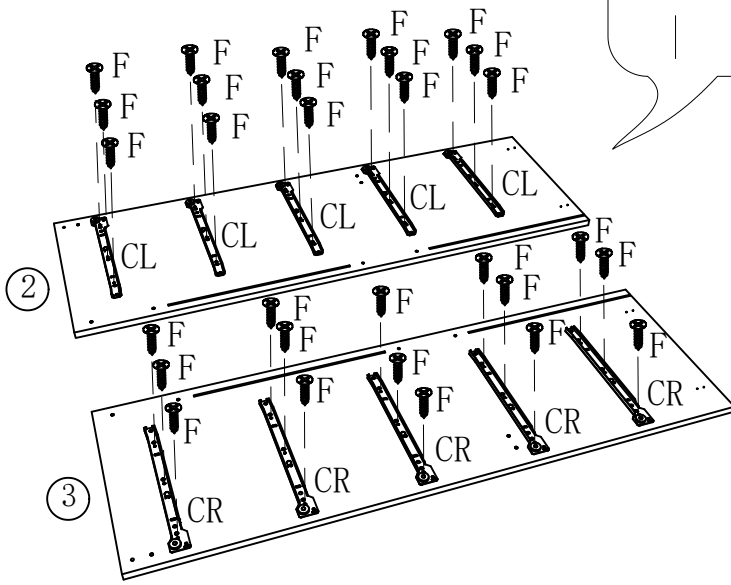
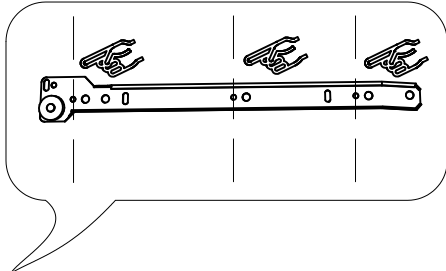

STEP 2

A	X16
	
M6X35	

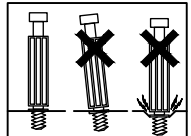
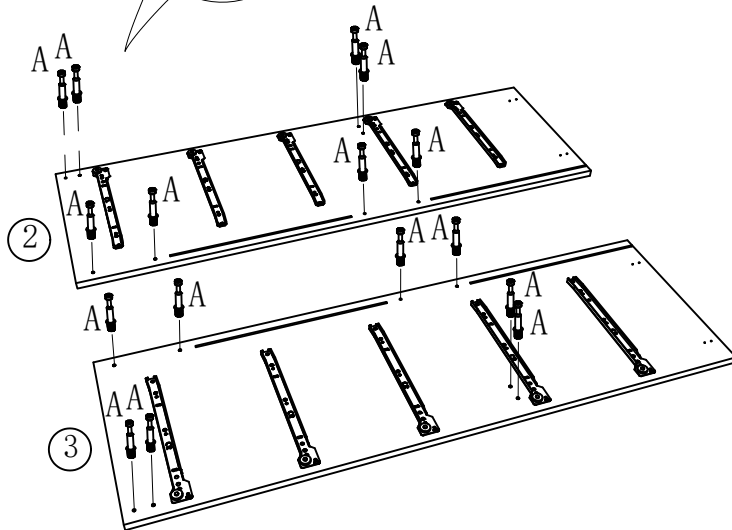
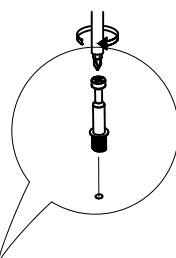

STEP3

B	X8
	
ø15X12	

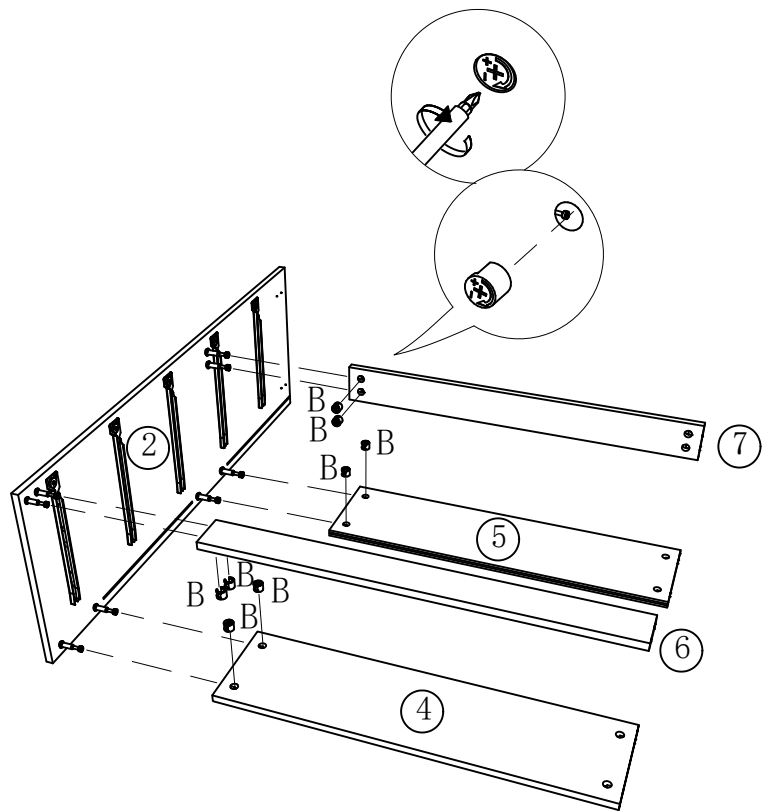

STEP4

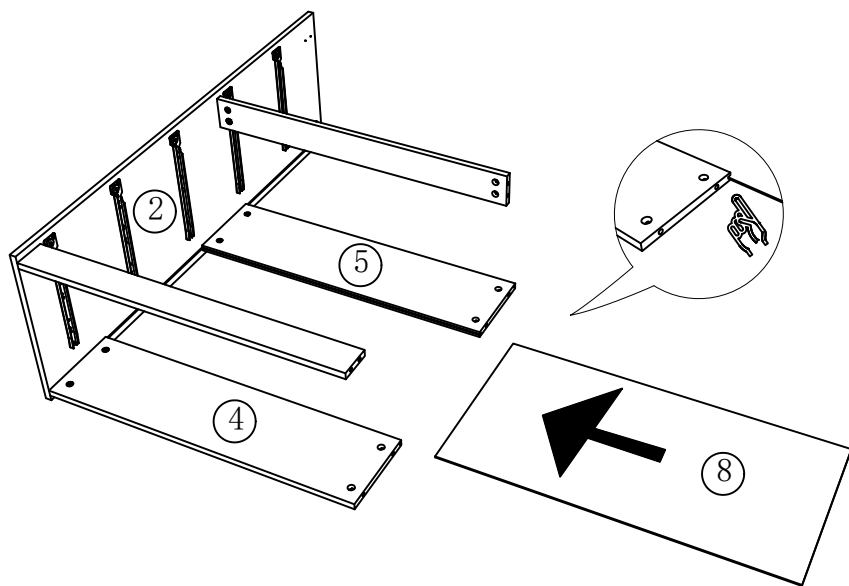

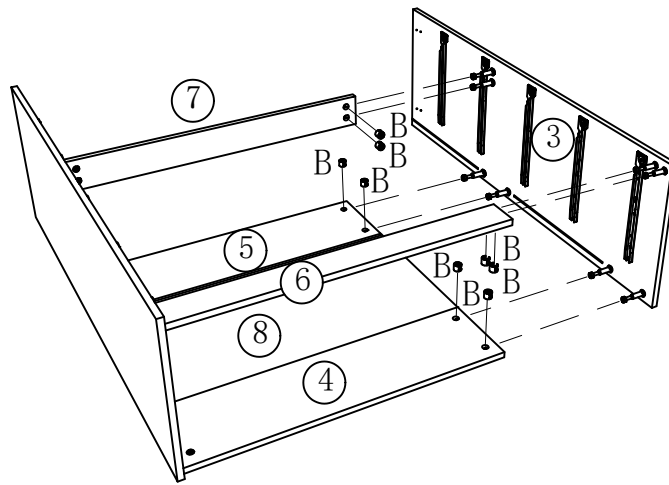
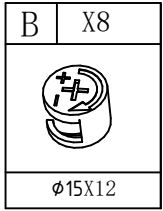

STEP 5

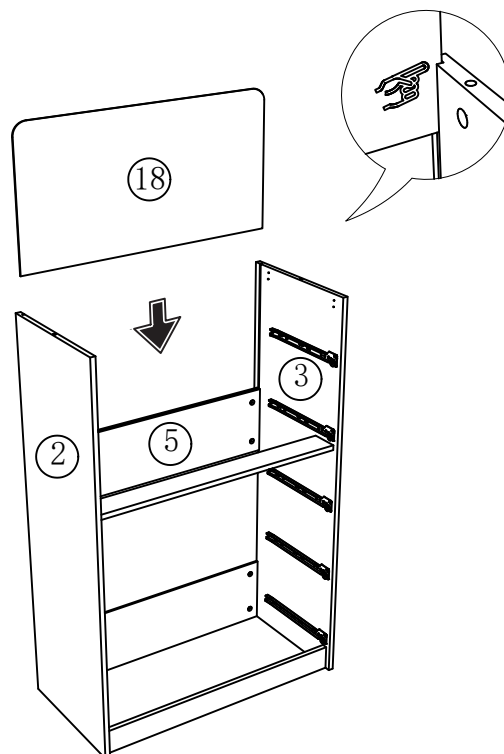

STEP 6



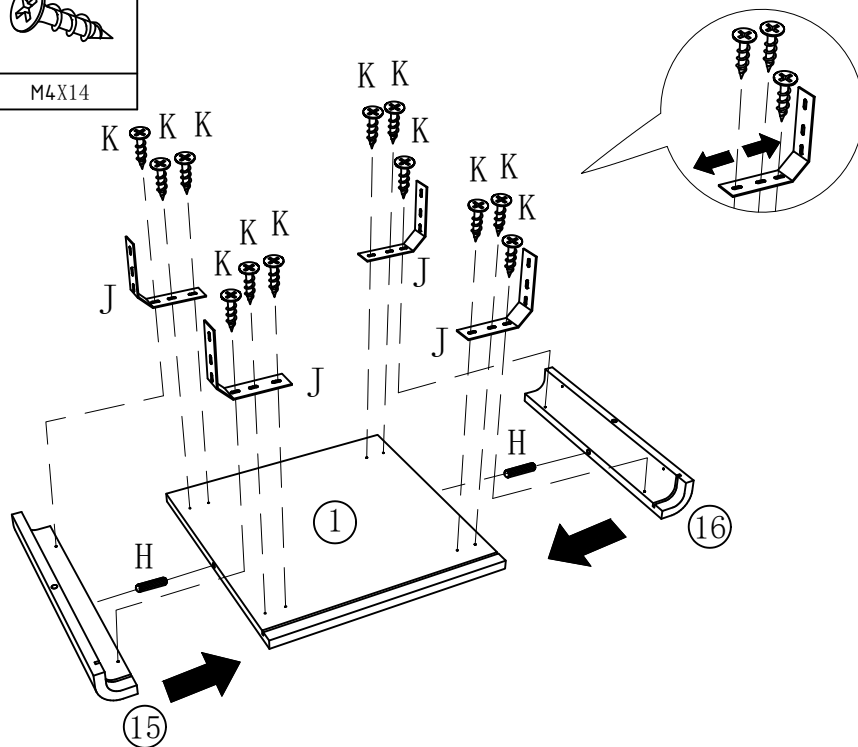

STEP 7

J	X4	H	X2	K	X12
					
		∅8X40		M4X14	





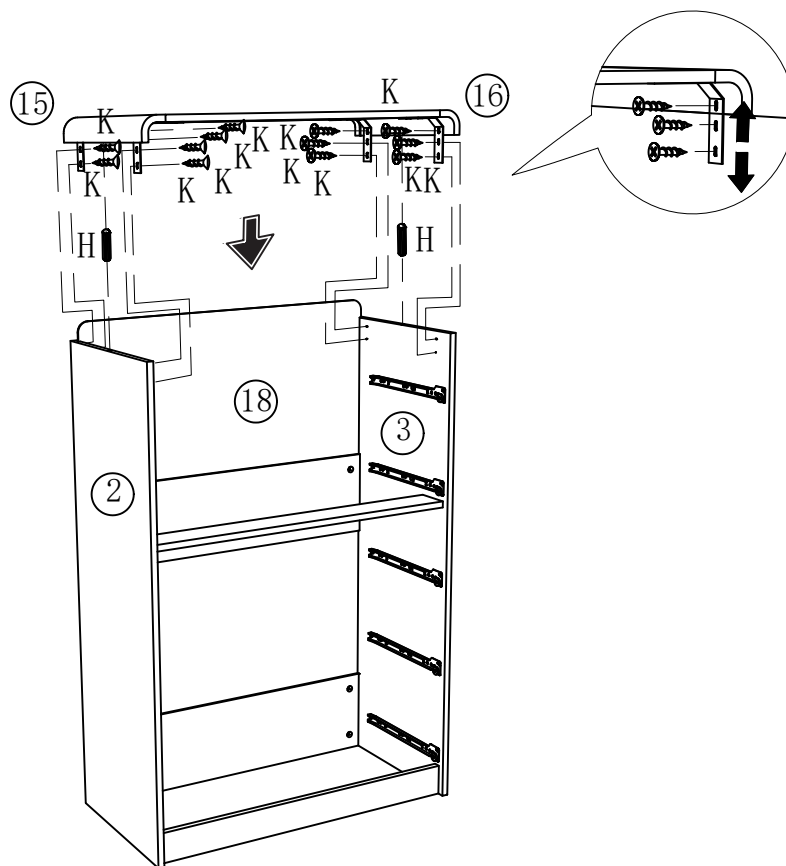

STEP 8

H	X2	K	X12
			
∅8X40		M4X14	

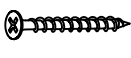

STEP9

A	X25	D	X20	E	X25	G	X10
							
M6X35		M3X12		M4X40			

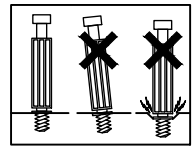
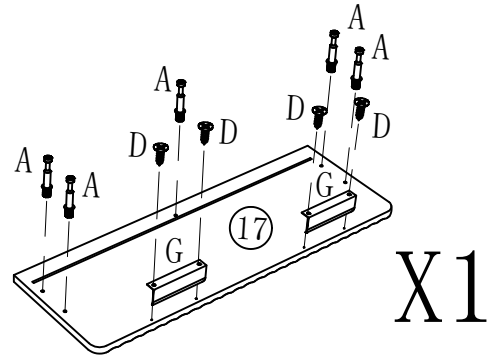
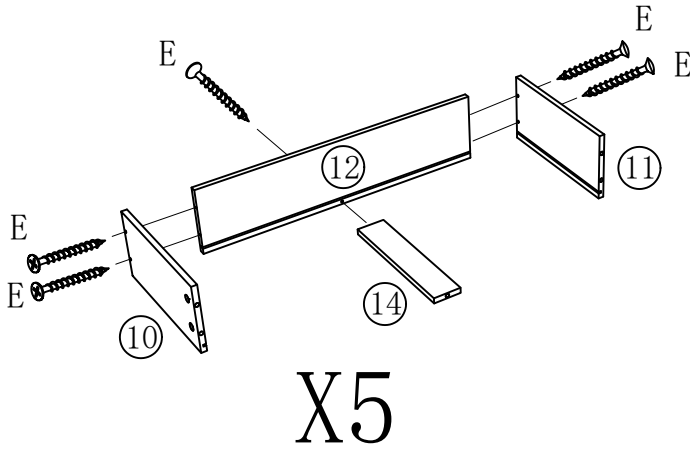
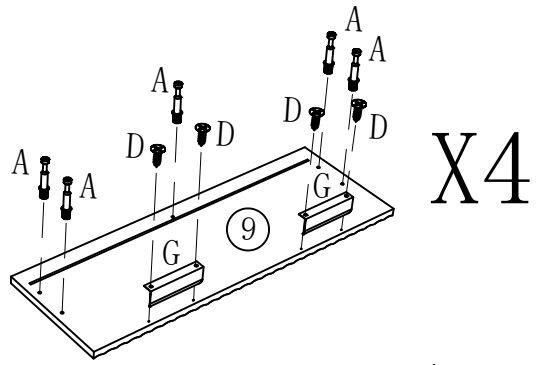

STEP10

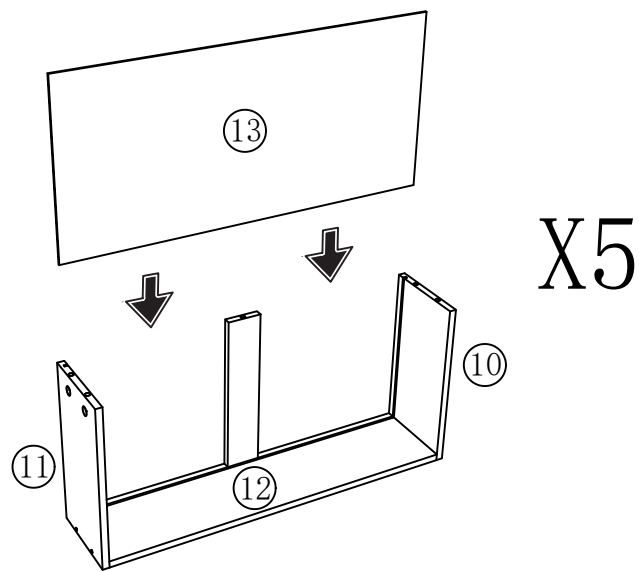

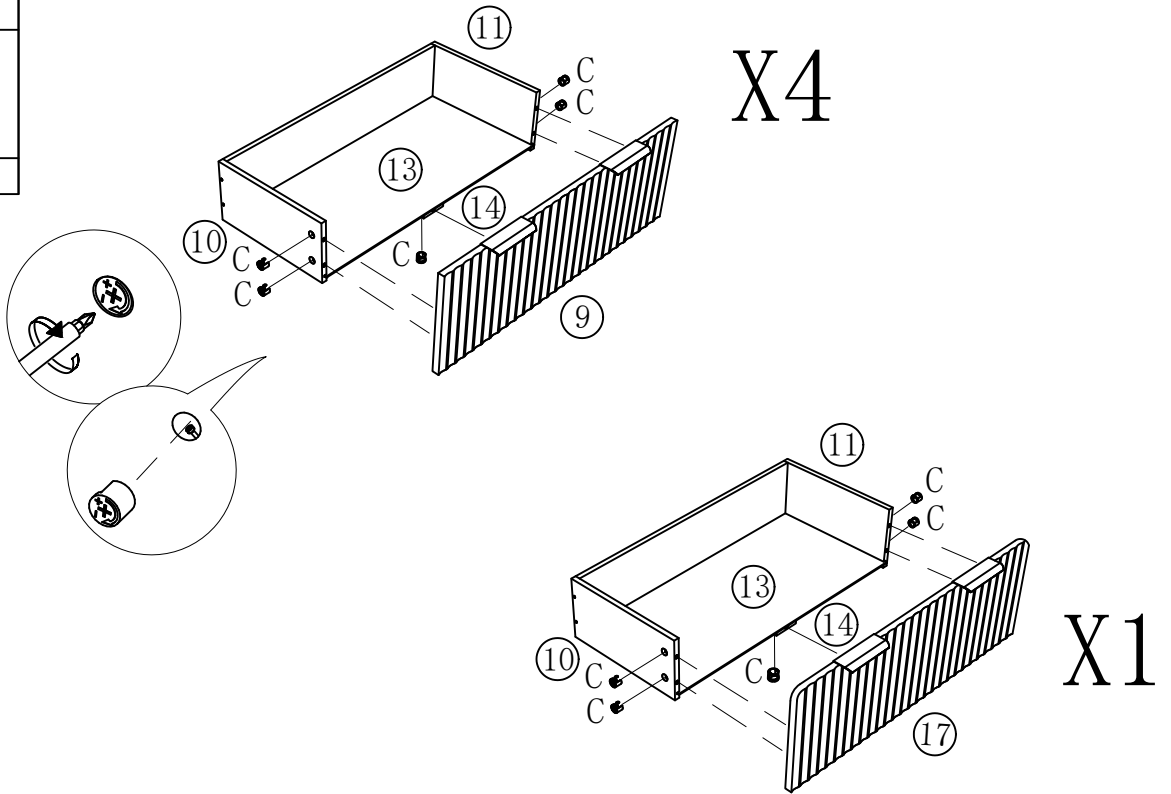

STEP 11

C	X25
	
ø15X10	



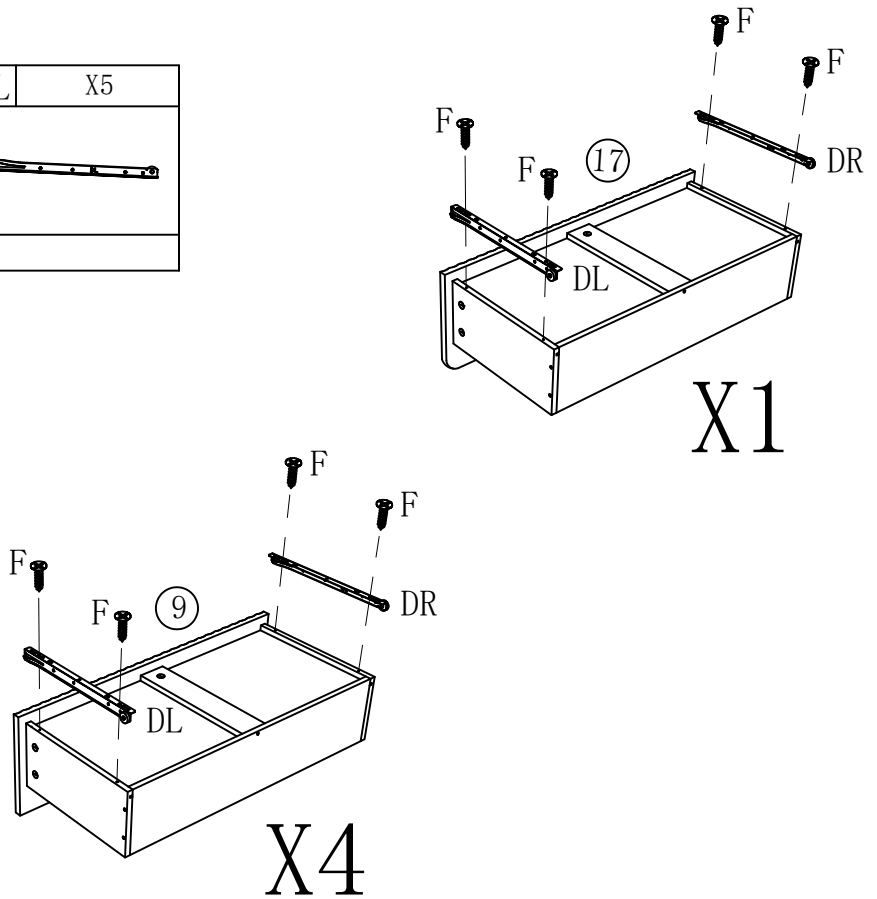
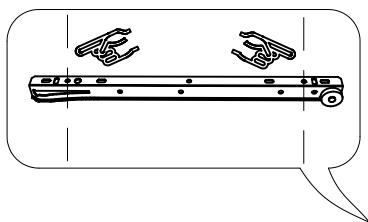

STEP 12

F	X20	DR	X5	DL	X5
					
M3X14					



STEP13

I	X8	F	X8
			
		M3X14	

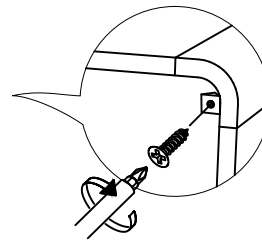
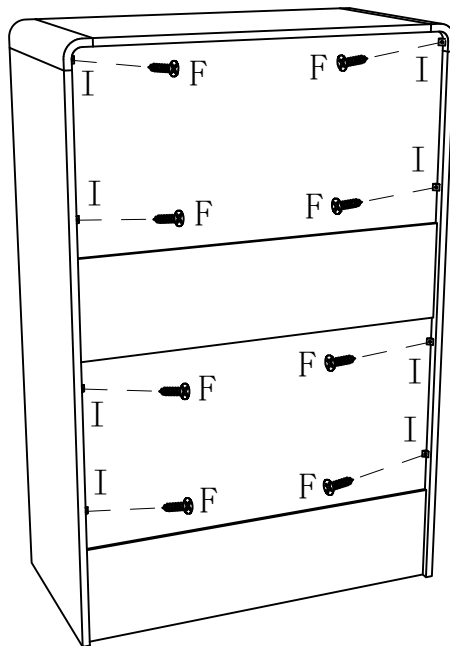

STEP14

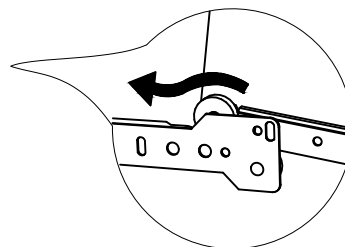
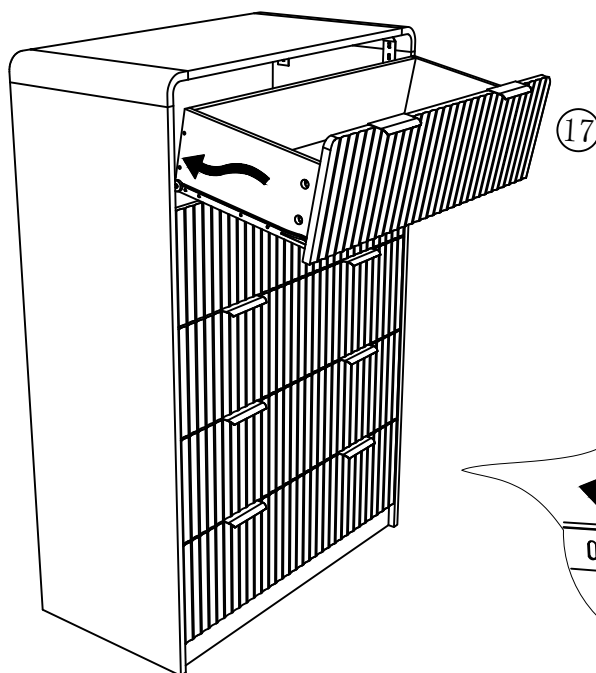

STEP 15

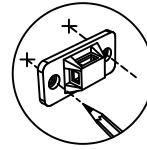
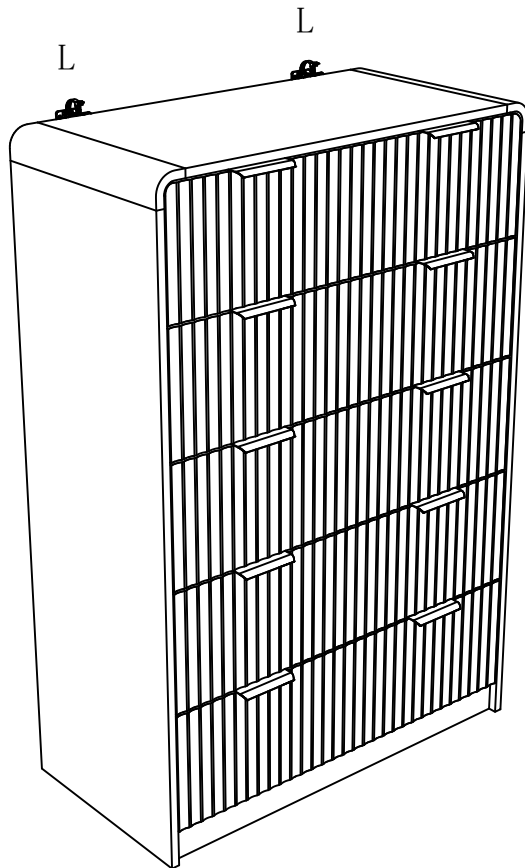
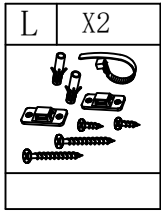

1, Mark on the wall.

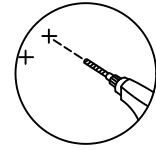

2, Drill holes in the wall.

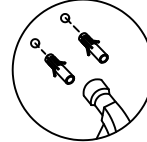

3, Push in the plastic tie plug.

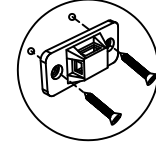

4, Insert long screws into the wall to fix the clasp.

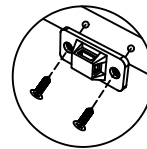

5, Secure the clasp with short screws at the top of the back thick plate.

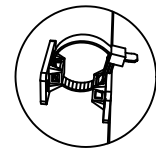

6, Push the plastic tie through the holes in the two clasps and tighten it.