

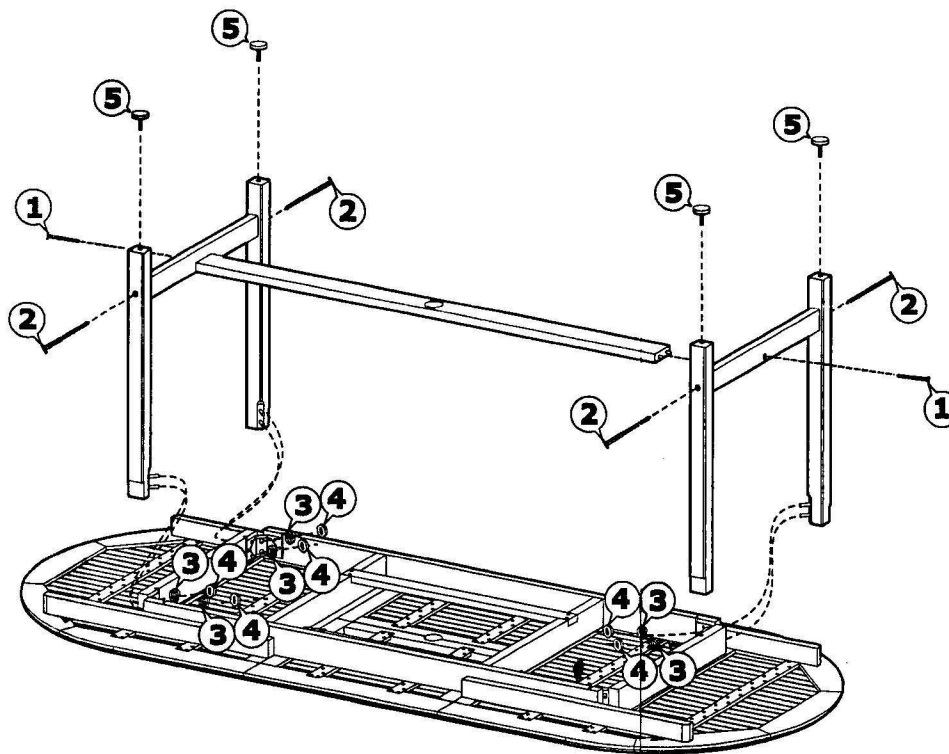



Assembly Instruction



- 1

 F-screw 6x70-T30, GS x 2 PCS
- 2

 F-screw 6x80-T30, GS x 4 PCS
- 3

 Spiral washer 8x13x2, GS x 8 PCS
- 4





 Hexagonal nut M8, GS x 8 PCS
- 5

 Table foot black, P x 4 PCS
- 6

 Hexagonal key M8, GS x 1 PCS
- 7

 Torx key T30, GS x 1 PCS
- 8

 SC brass center for ph, Ø 50mm, SB x 1 PCS

DIAN EXT. OVAL DINING TABLE 71"-94"X39", 29"H, W/ PH, TEA