

## WARNING

- \* Switch off the main electrical supply from the main fuse box / circuit breaker before installation.
- \* Inspect item carefully before attempting to install.
- \* If there is any damages or obvious defects, do not install.
- \* Item may not be returned once it has been installed.











## CARE AND MAINTENANCE

- \* To clean the outside of the fixture, use a dry or slightly dampened clean cloth (use clean water, never a solvent) to wipe the surface of the fixture.
- \* To clean the inside of the fixture, first disconnect power to the fixture by turning off the circuit breaker or by removing the fuse at the fuse box. Next, use a dry or slightly dampened clean cloth (use clean water, never a solvent) to wipe the interior surface of the fixture.
- \* Do not use any cleaners with chemical, solvents or harsh abrasives. Use only a dry soft cloth to dust or wipe carefully.

## NOTICE& IMPORTANT SAFETY INSTRUCTIONS

- \* Please make sure that you have all parts indicated before you begin assembly of this item
- \* This item should be assembled on a soft surface to prevent scratching the finish during assembly
- \* To reduce the risk of fire, electrical shock or injury to persons or property, please follow the guideline below for safe use and installation
- \*The external flexible cable or cord of this luminaire cannot be replaced  
If the cord is damaged, the luminaire shall be destroyed

### Part List and Hardware List

PIECE	DESCRIPTION	PICTURE	QUANTITY	PIECE	DESCRIPTION	PICTURE	QUANTITY
A	machine screw		2X	G	glass		1X
B	mounting bracket		1X	H	wire cage		1X
C	ground screw		1X	I	rubber ring		2X
D	wire connector		3X	J	screw		2X
E	fixture		1X	K	bulb		1X
F	cap nut		1X				

## Owner Manual

Product Dimensions: 7.875"L X 7.875"W X 4"H

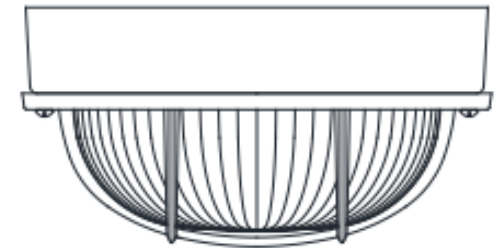

## PREPARATION

- \* Before beginning assembly of product, make sure all parts are present. Compare parts with package contents list and hardware contents list.
- \* If any part is missing or damaged, do not attempt to assemble the product.
- \* Estimated Assembly Time: 20 minutes.
- \* Tools Required for Assembly (not included): Screwdriver, Junction box
- \* If you are having difficulty, our friendly Customer Care team is always here to help.

**NOTE: PLEASE USE TYPE "A" BULB MAX 25-WATT OR LED BULB MAX 5-WATT, THERE ARE 1PCS LED 4-WATT BULB IN THE BOX**

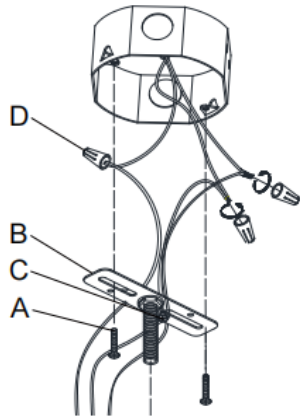

### Step 1:

Attach the mounting bracket(B) to the outlet box using the machine screws(A).

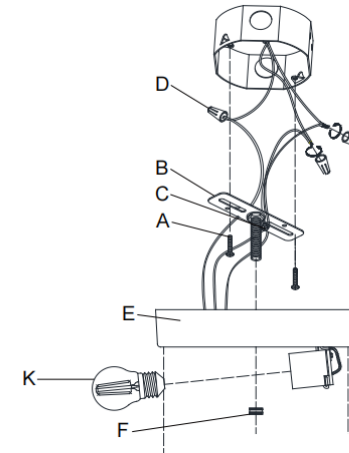

### Step 2:

Place fixture(E) over outlet box with nipple protruding through center hole of fixture(E). Secure into place with cap nut(F).

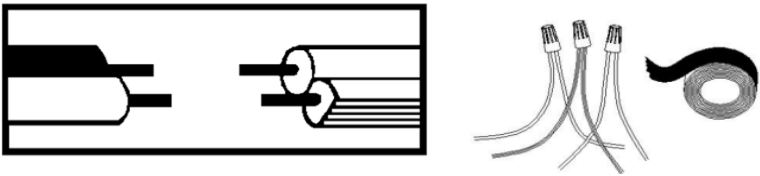

### Step 3:

Make wire connections, with wire nut

Connect fixture neutral wire (ribbed) to the outlet box neutral wire (usually white) using a wire nut. Connect fixture hot wire (smooth with markings) to the outlet box hot wire (usually black) using a wire nut.

**CAUTION:** Do not reverse the hot and neutral connections

Grounding Instructions:

Wrap ground wire from outlet box around green ground screw(Q) on mounting bracket, no less than 2" from wire end. Tighten ground screw. If fixture is supplied with a ground wire, connect to outlet ground wire with a wire nut.

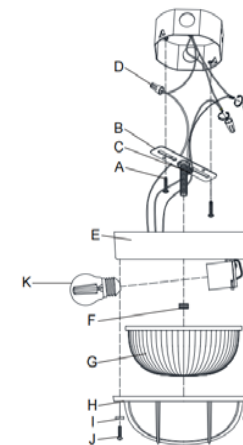

### Step 4:

Screw the Bulb(K) into the socket. Place the glass(G) on the fixture, Attach wire cage(H) over the Shade and secure with rubber rings(I) and screws(J).