

Installation & Assembly

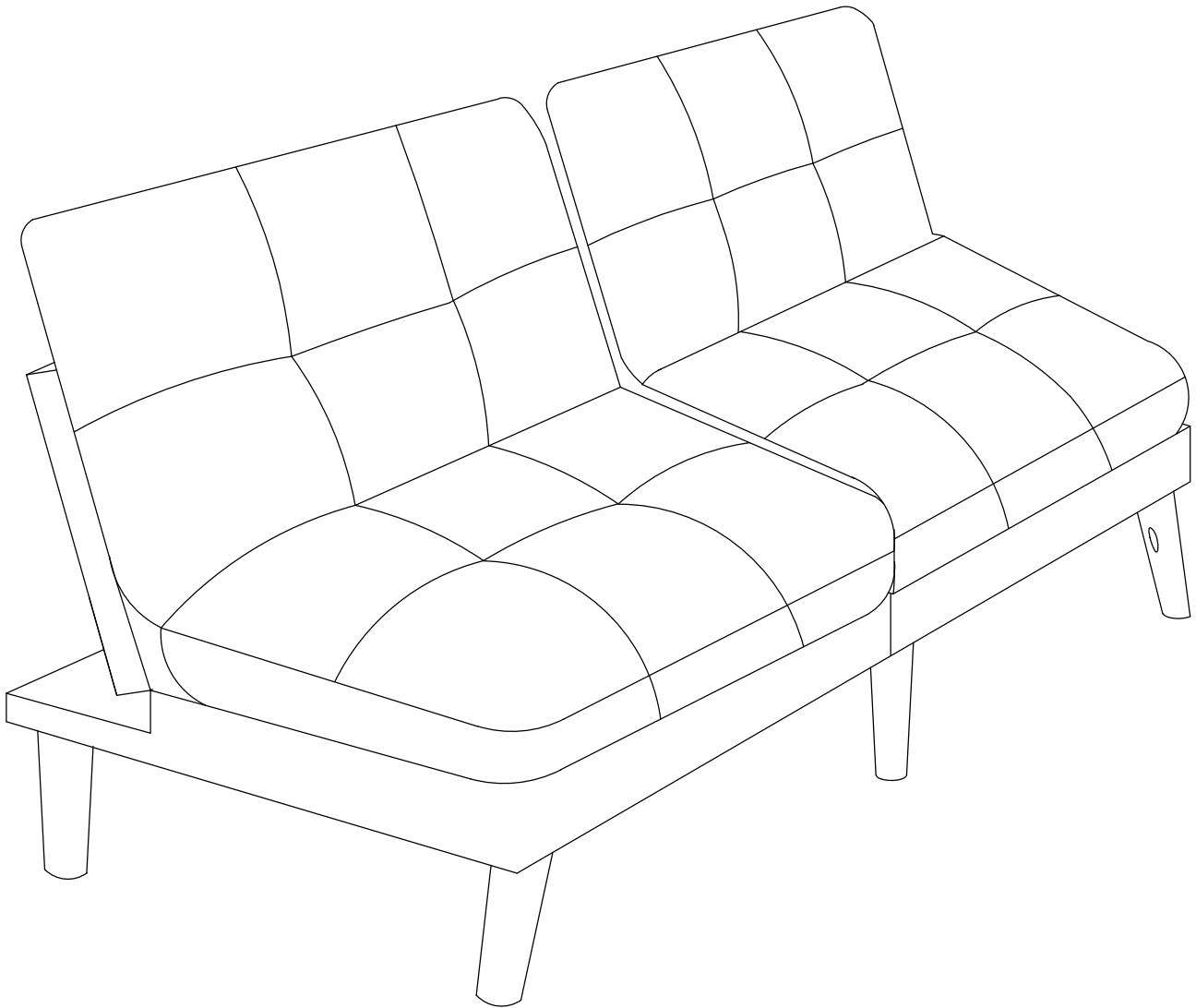

Instruction Manual

Thank you for shopping with us!

If any parts is missing, broken upon receipt or you need any help from us. For the FASTEST solutions, please FIRSTLY CONTACT US at our after-sales

Accessories List

Note: All the parts or hardware marked with *aer tucked under seat frame

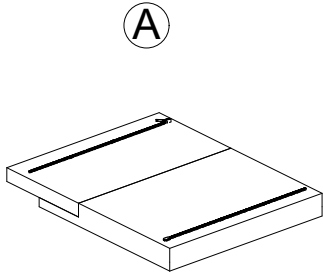

Left seat frame

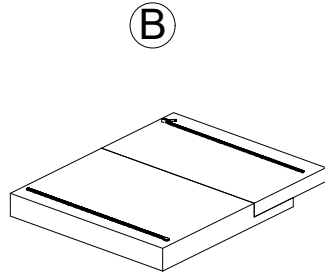

Right seat frame

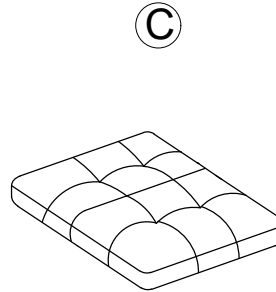

Left cushions and backrests

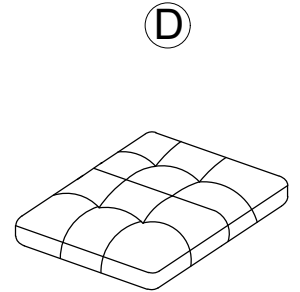

Right cushions and backrests

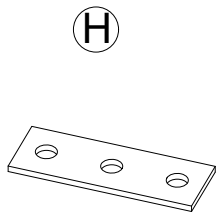

70X25X3 Foot plate (2)

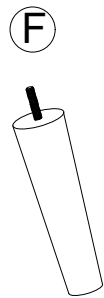

Middle foot of sofa (4)

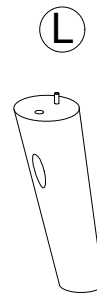

Sofa foot (2)



8x22 Screw (4)





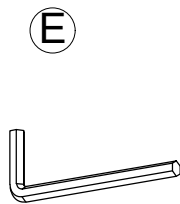



8x50 Screw (2)

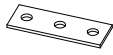

M5x95x35 Wrench (1)

Step 1: Fix the metal plates to make the seat frames connected follow by installing the legs.

| | | | | | |
|---|---|--|---|---|---|
| F*4  178*60mm | L*2  180*60mm | H*2  70X25X3mm | K*2  8x50mm | G*4  8x22mm | E  M5x95x35mm |
|---|---|--|---|---|---|

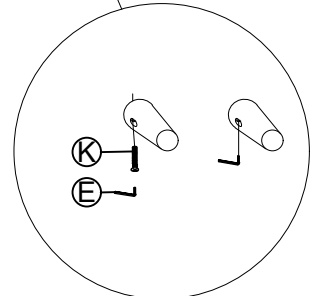
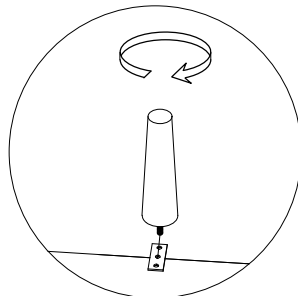
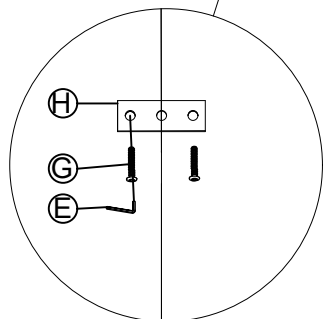
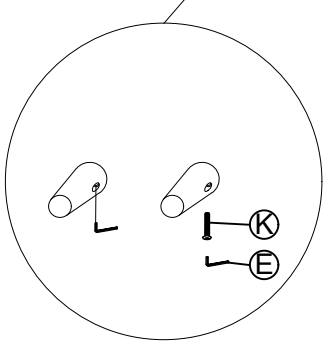
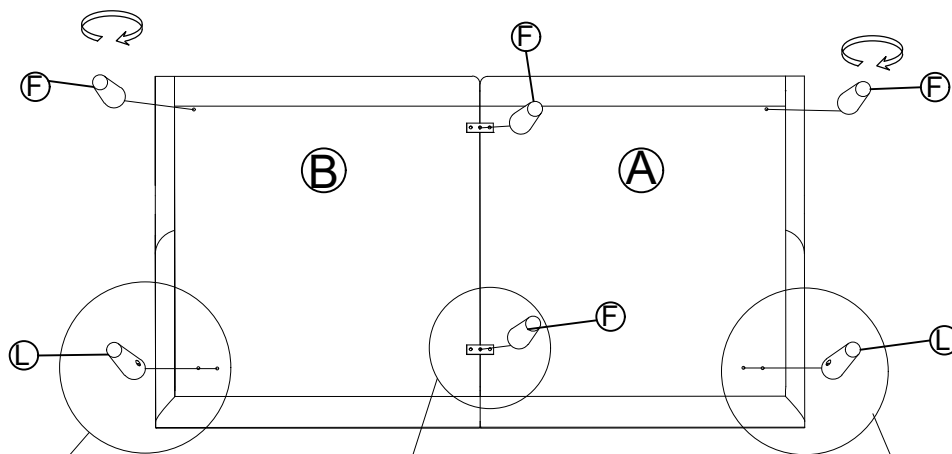

Step 2: Cut the compression bag

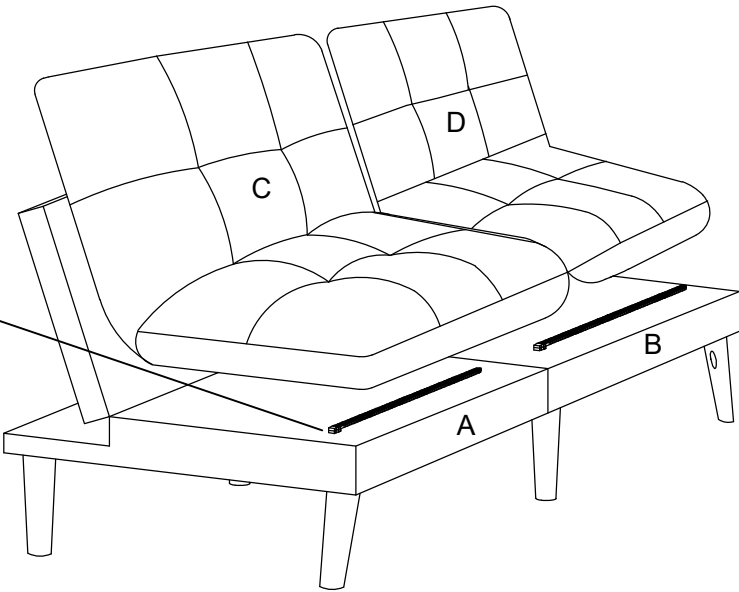
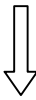
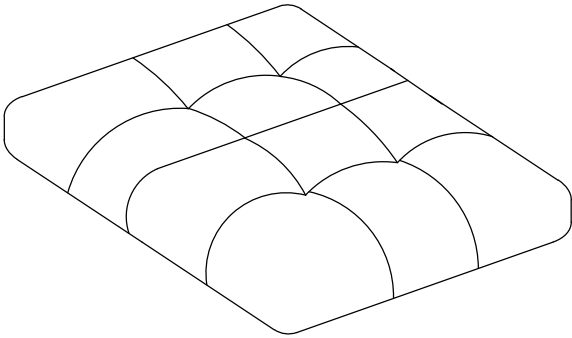
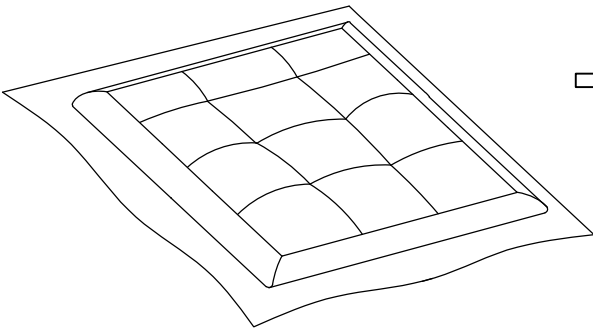
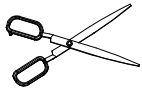
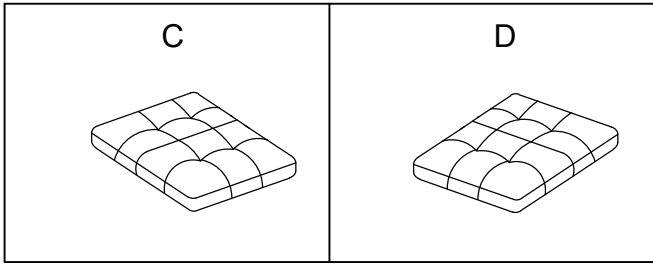

Step 3: The backrest is adjustable for three angles.

Tip: Pull the backrest forward till you hear the snap sound and push it backwards slowly to the angle you want.

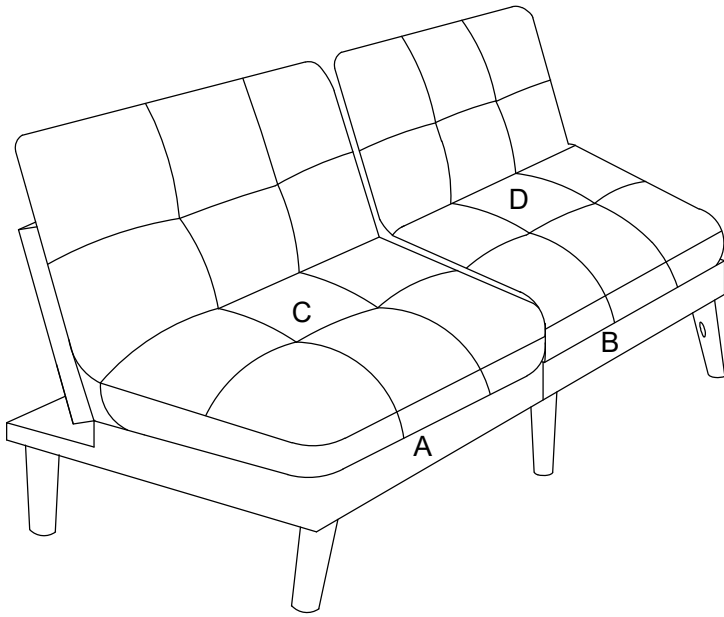

Angle One
105°

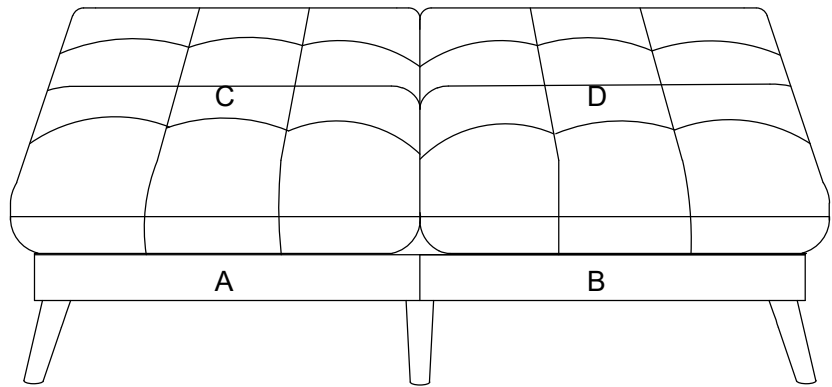

Angle Three
180°

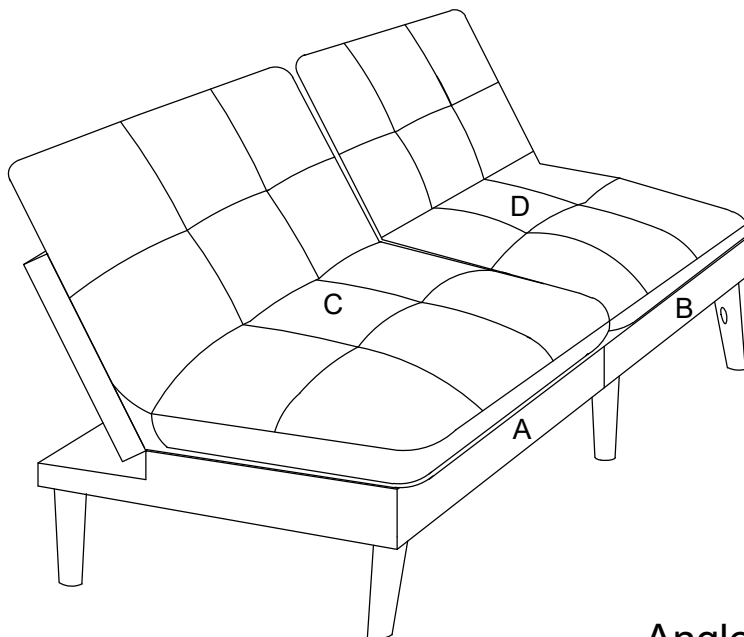

Angle Two
135°