

ASSEMBLY TIPS:

- 1.Remove hardware from box and sort by size.
- 2.Please check to see that all hardware and parts are present prior to start of assembly.
- 3.Please follow attached instructions in the same sequence as numbered to assure fast & easy assembly.







Warning!!





- 1.Don't attempt to repair or modify parts that are broken or defective.Please contact the store immediately.
- 2.This product is for home use only and not intended for commercial establishment.

ASSEMBLY TIME PER UNIT: 25 MINUTES

PARTS IDENTIFICATION

A				B			
BOX		1PC		DRAWER		1PC	
C				D			
SIDE FRAME		2PCS		BOTTOM FRAME		1PC	
E							
POWERSOCKET		1PC					

HARDWARE PACKAGE

Z	DESCRIPTION	FIGURE	Q'TY
1	SHORT BOLT		4PCS
2	LONG BOLT		4PCS
3	SCREW		2PCS
4	LEVELER		4PCS
5	ALLEN WRENCH		1PC

STEP 1

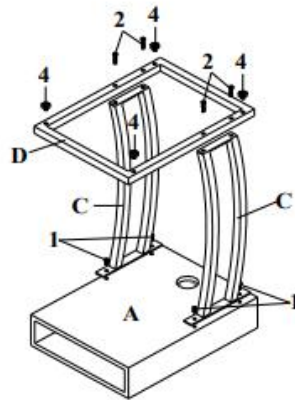

STEP 2

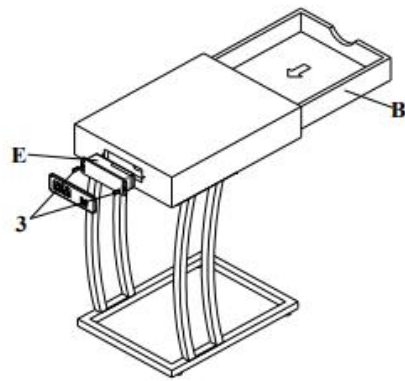

FINISH

