

AUFBAUANLEITUNG

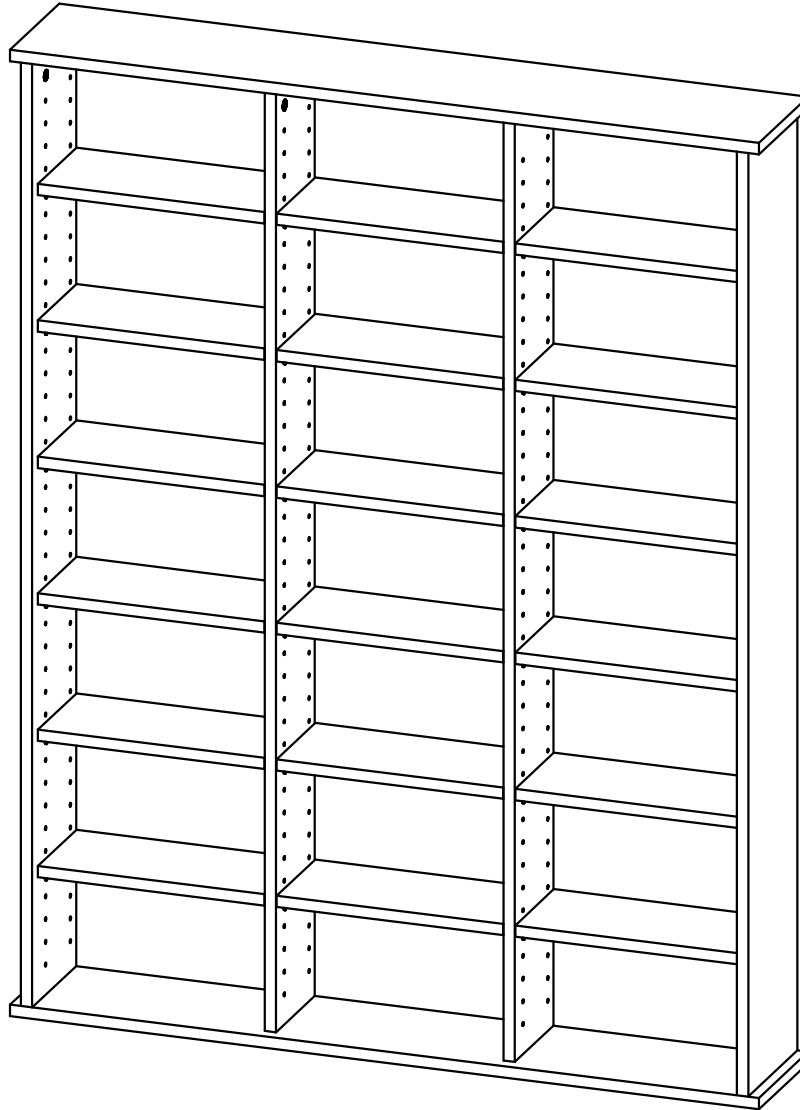

Hauptabmessungen:

Breite 105,4 cm

Tiefe 19 cm

Höhe 136 cm



HINWEIS!

Mit allen diesbezüglichen Fragen und Reklamationen wenden Sie sich bitte an ihren Verkäufer.
Vorsicht! Falls Sie irgendwelche beschädigte Teile bemerken verzichten Sie bitte auf die Montage.

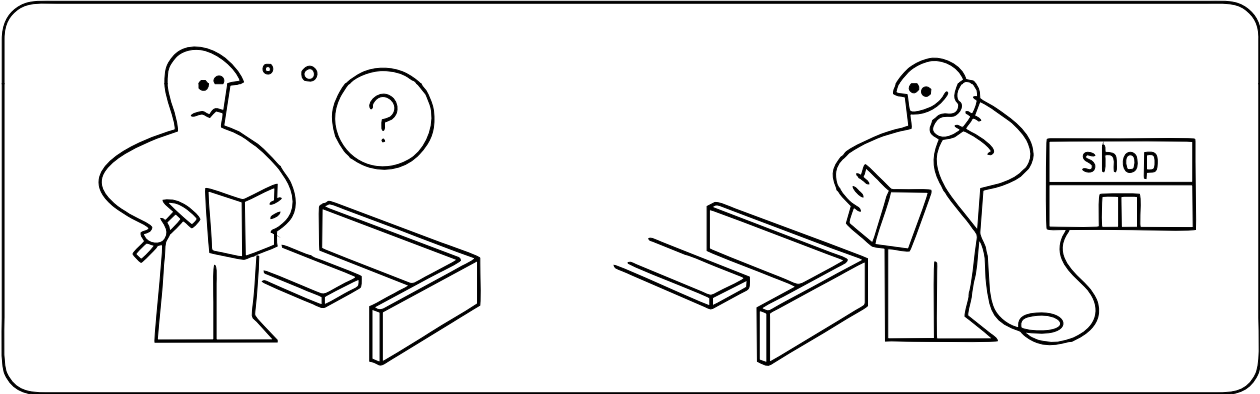
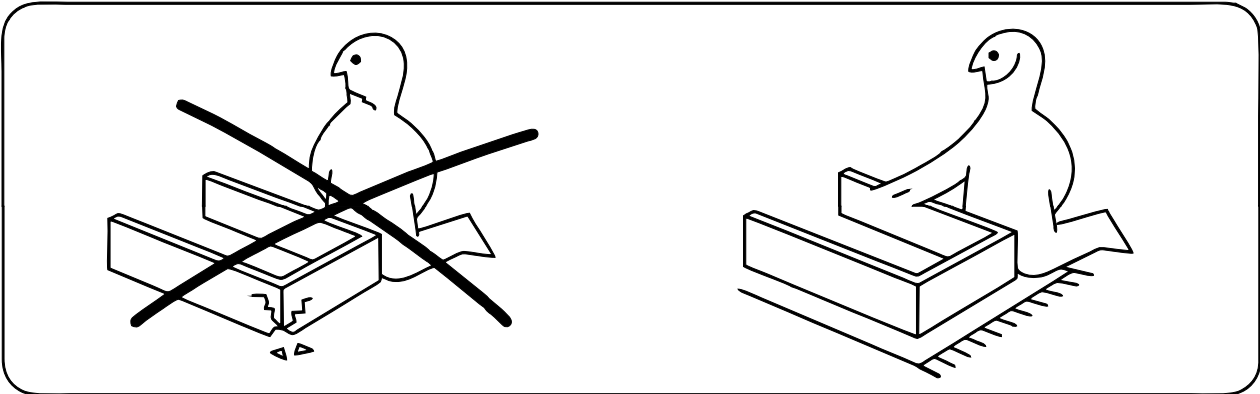
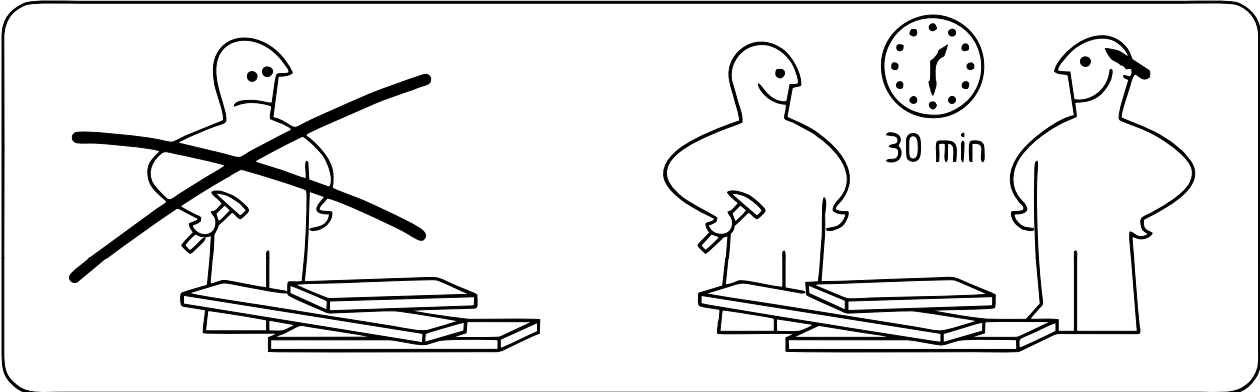
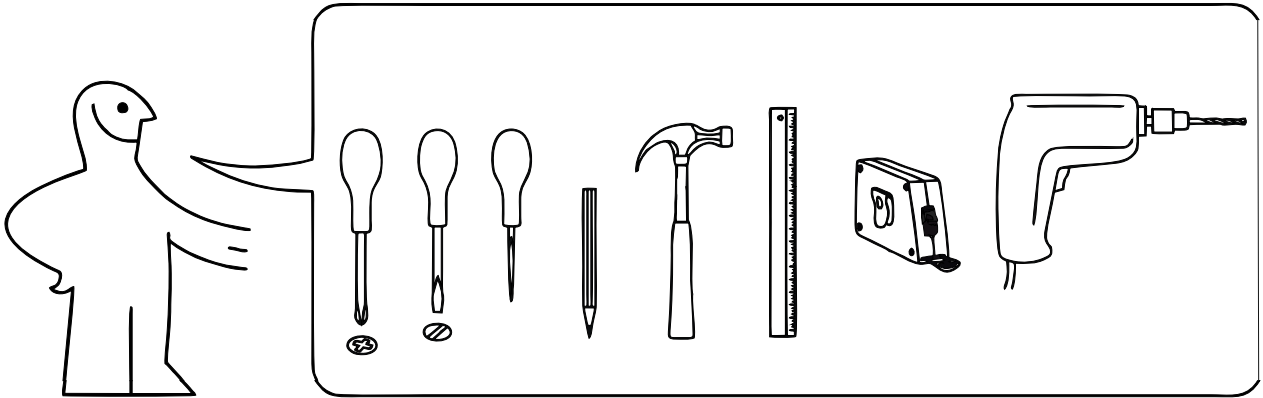

Elemente:

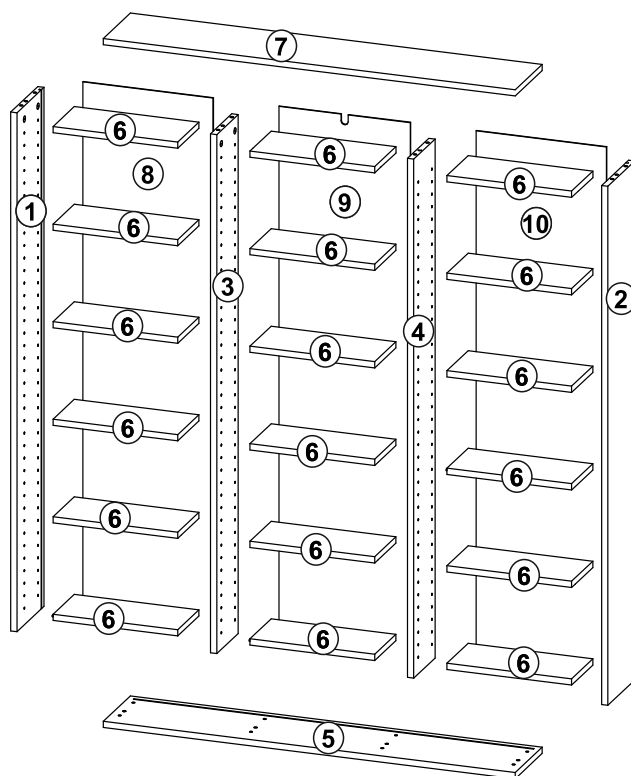

Elemente- zeichen	Ausmaß	Paket	Anzahl	Elemente- zeichen	Ausmaß	Paket	Anzahl
1	1328 170	1/1	1	8	1338 333	1/1	1
2	1328 170	1/1	1	9	1338 336	1/1	1
3	1328 150	1/1	1	10	1338 333	1/1	1
4	1328 150	1/1	1	Zubehör			
5	1054 190	1/1	1			1/1	1
6	320 150	1/1	18				
7	1054 190	1/1	1				

Zubehör:

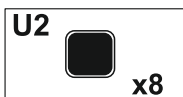
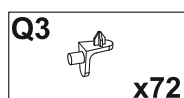
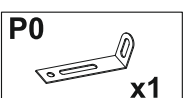
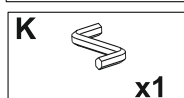
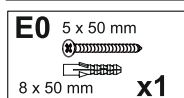
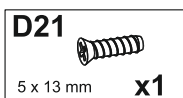
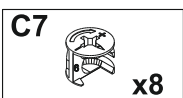
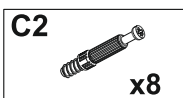
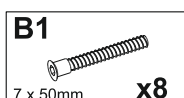
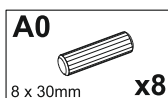

HINWEISE ZUR NUTZUNG UND PFLEGE DER MÖBEL

1. Die Möbel nur in trockenen, von den schädigenden atmosphärischen Einwirkungen geschützten Räumen nutzen.
2. Die Montage mit laut Aufbauanleitung geeigneten Werkzeugen durchführen.
3. Die Montagestelle soll sich möglichst nah der Nutzstelle befinden.
4. Die Möbel sollen waagrecht aufgestellt werden.
5. Beim Umstellen sollen die Möbel entladen werden.
Vorsicht: beim Verschieben können die Möbel beschädigt werden.
 Beim Tragen nur vertikale Teile greifen. Waagerechte Elemente wie Blätter, Schubladen, können beschädigt werden.
6. Überlasten der Möbel kann zur Schädigungen führen.
7. Zeitweise außermittige Verbindungen kontrollieren.
8. Die Oberfläche der Möbel mit feuchtem Lappen oder Papierhandtuch reinigen.
 Keine chemischen Reinigungsmittel gebrauchen.



1

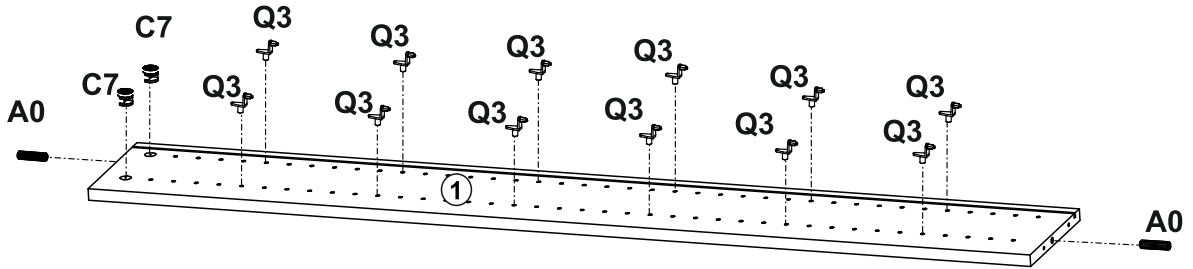
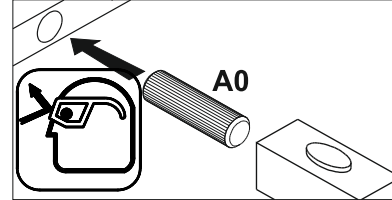
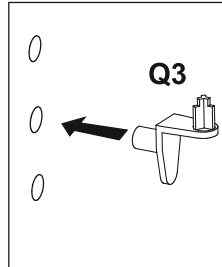
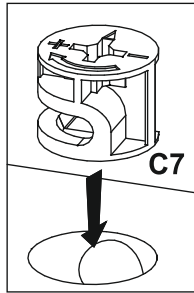

2

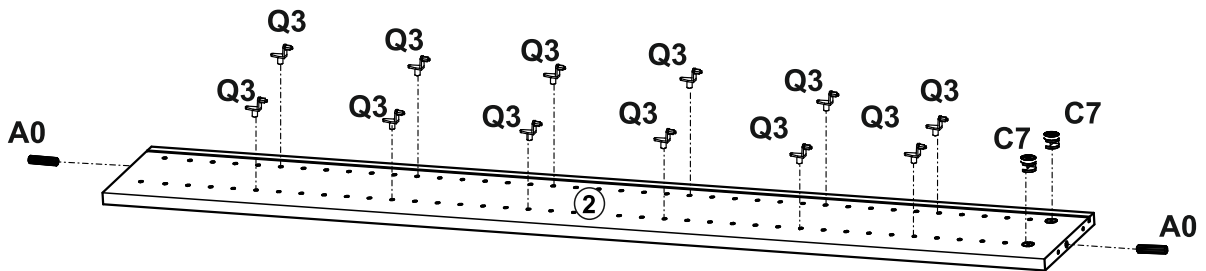
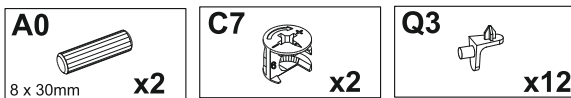

3

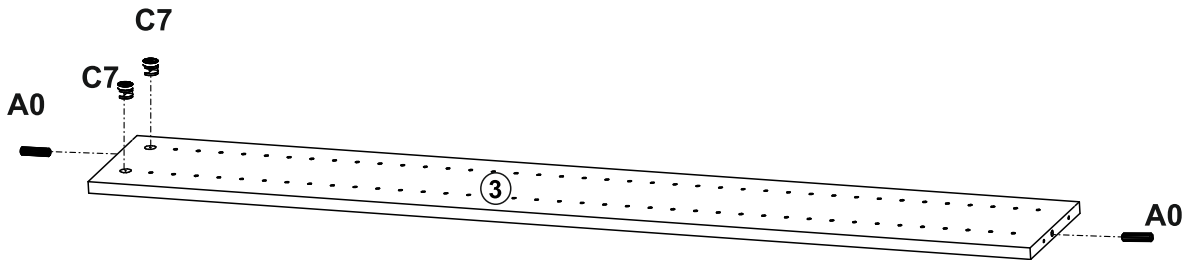
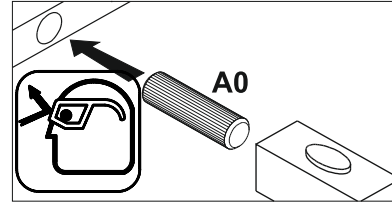
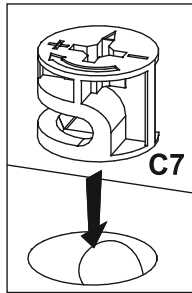
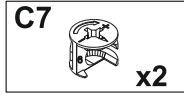
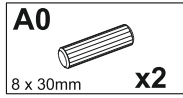

4

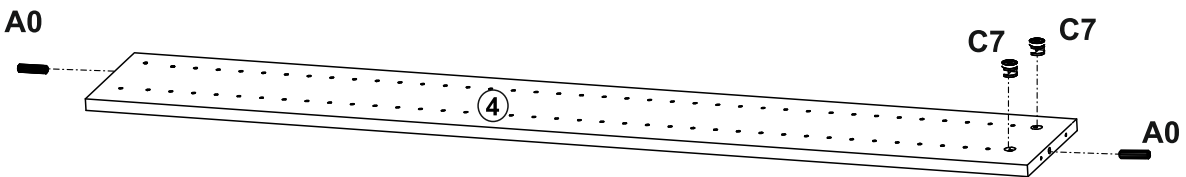
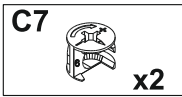
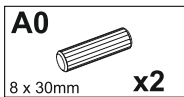

6

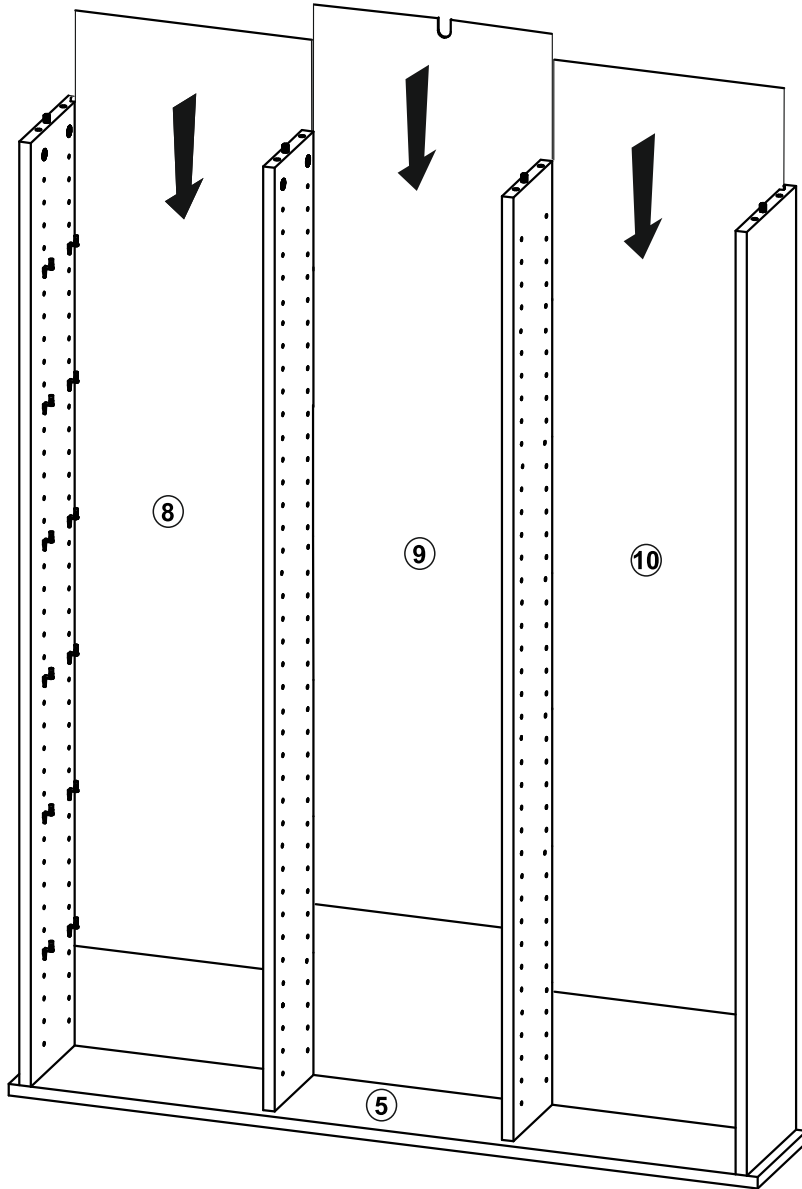

7

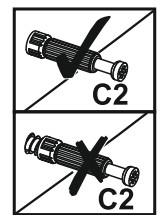
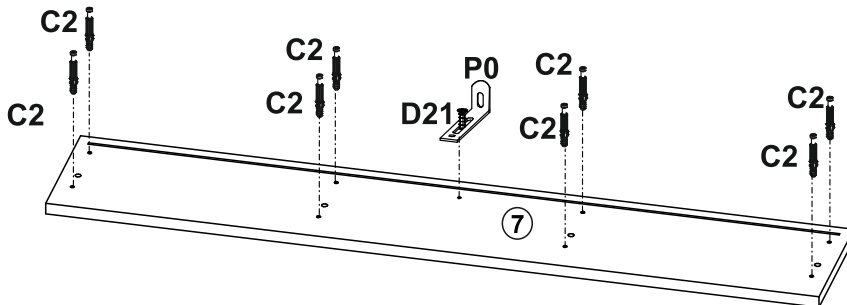
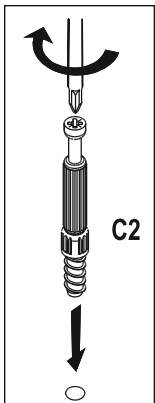
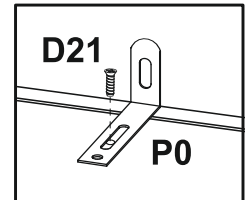
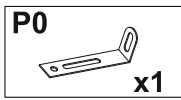
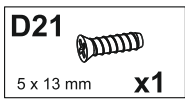
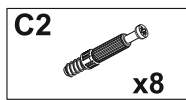

8

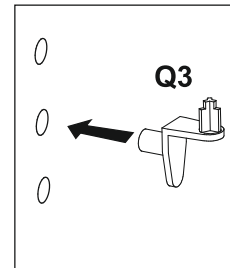
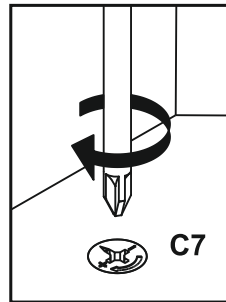
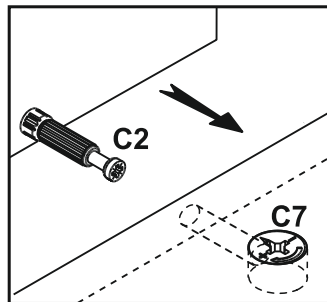
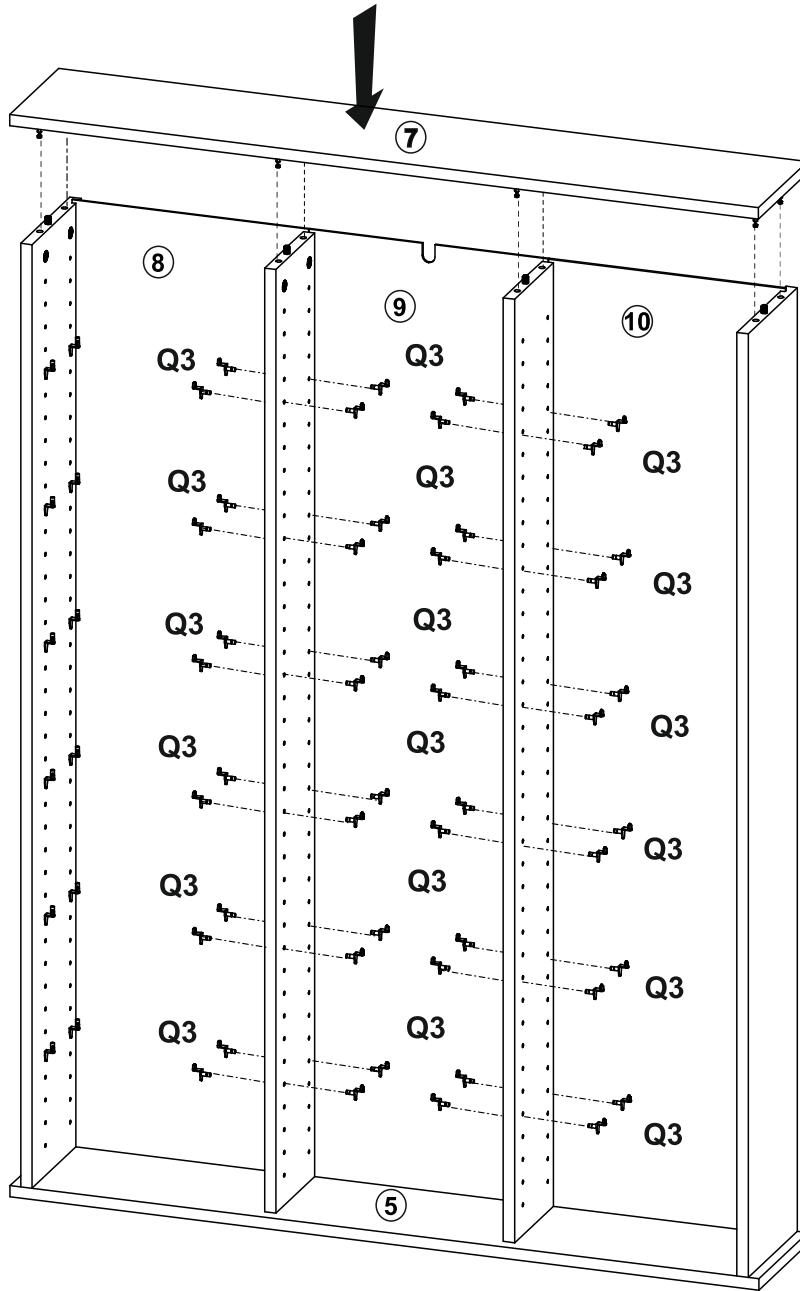
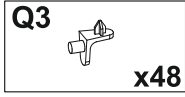

9

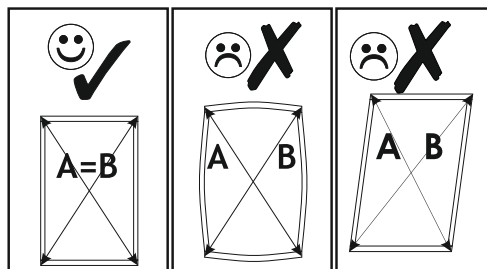
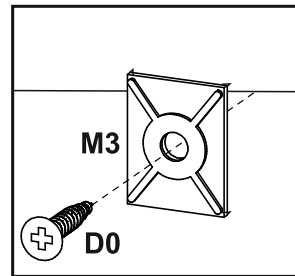
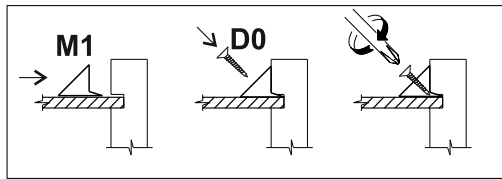
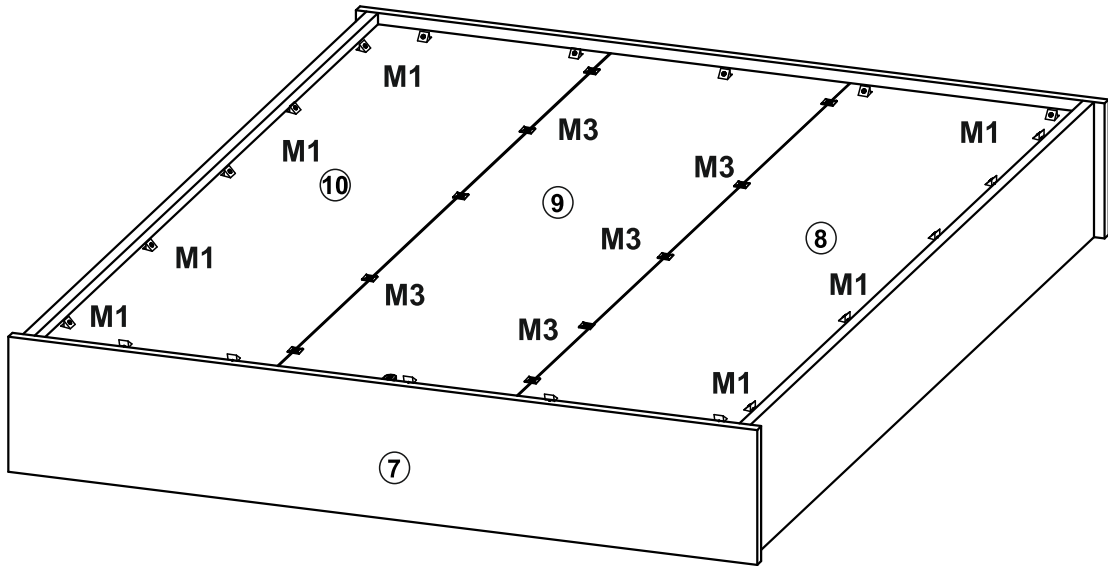
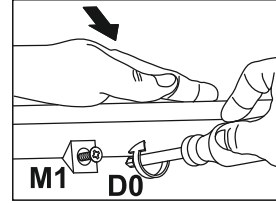
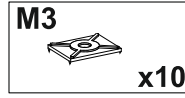
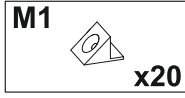
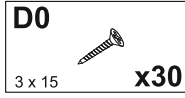

10

E0 5 x 50 mm
8 x 50 mm x1

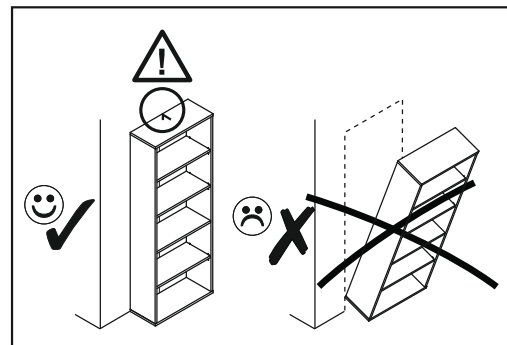
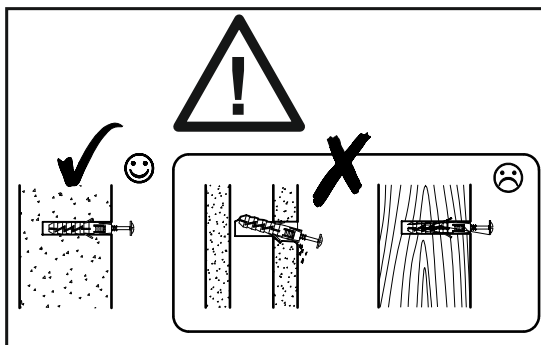
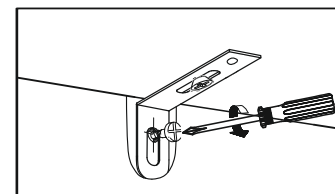
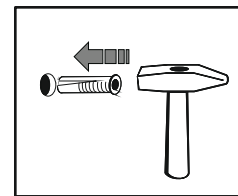
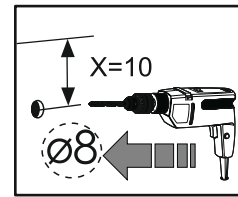
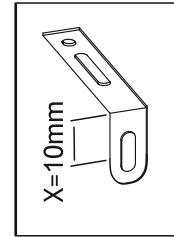
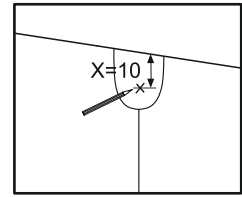
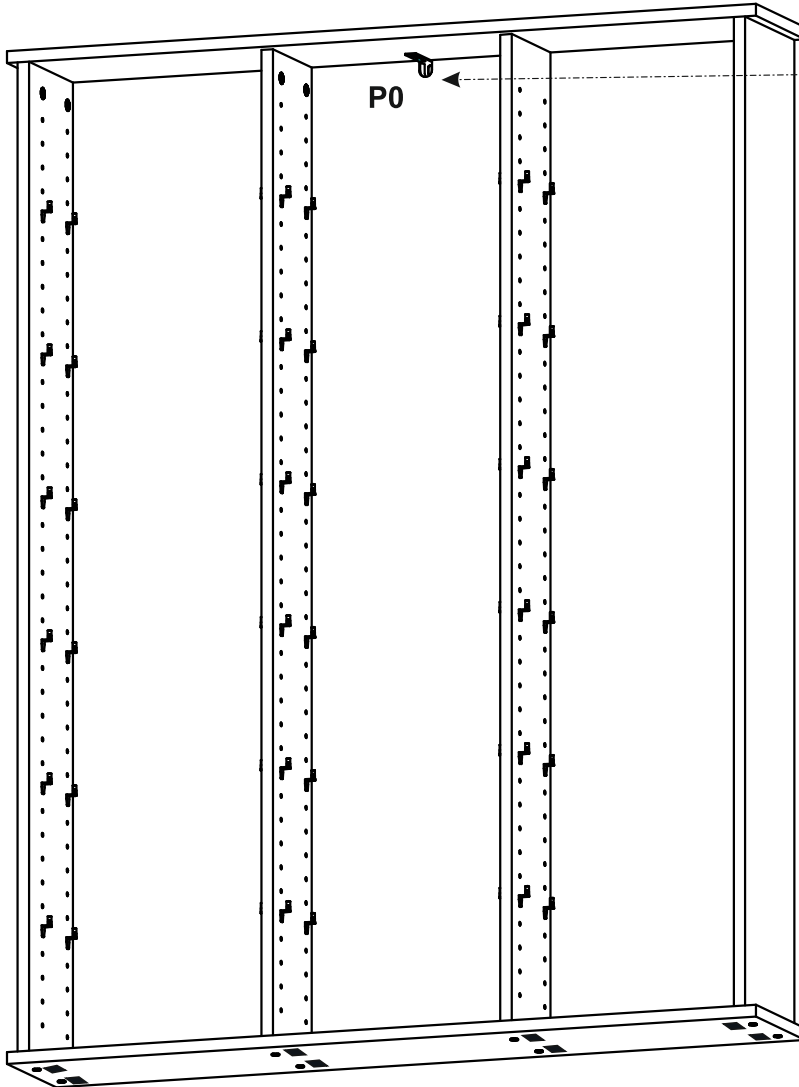

11

