

Assembly Instructions

Caution : You must read this before you proceed

Please look in the Left Leg Pane for hardware packs.

CHAIR

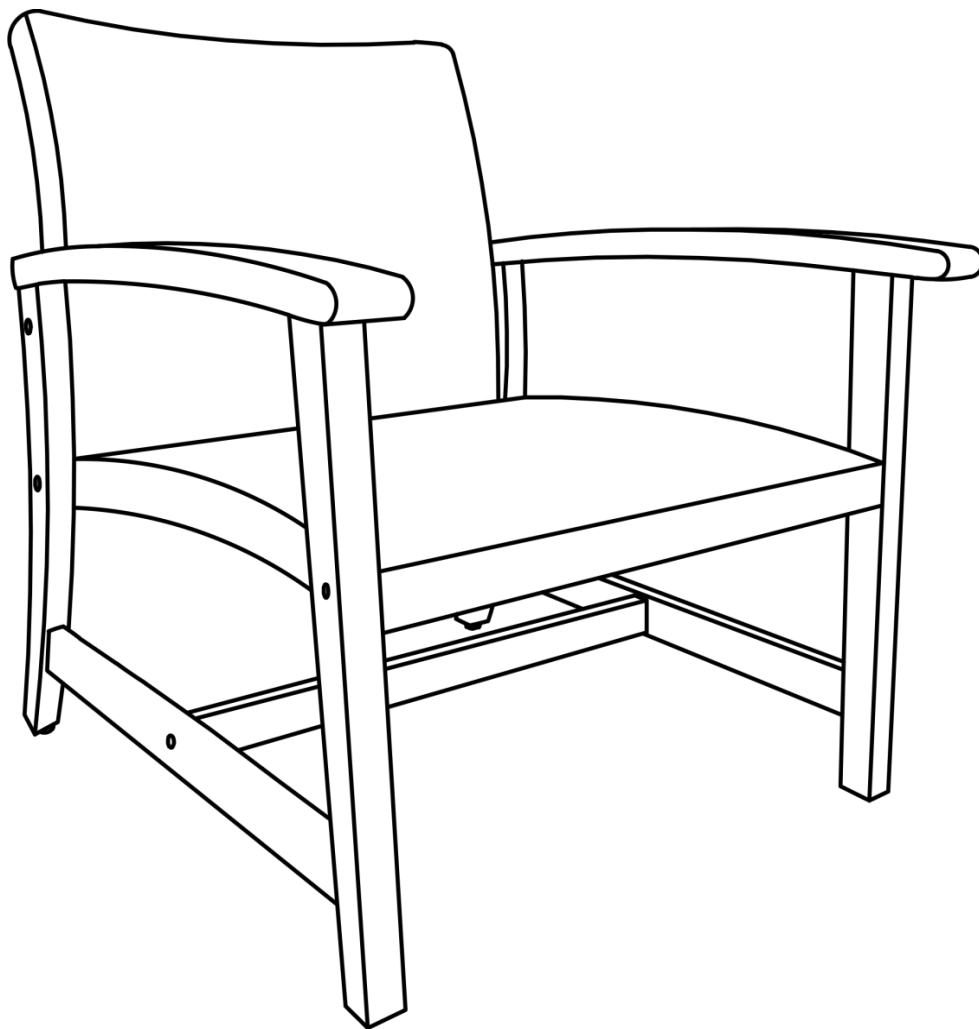

CAUTION : This Chair is NOT a TOY.



Keep your child / children at bay in the process of assembly.

For turning the Chair and to prevent damage to the Chair, 02 persons may be needed to execute this action.

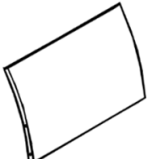
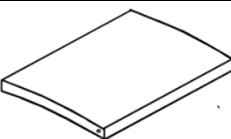
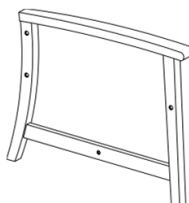
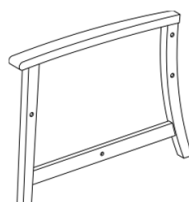
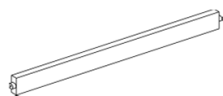
Parts List

Label	Picture	Description	QTY
A		Backrest Panel	1
B		Seat Panel	1
C		Left Leg Panel (with Leveler)	1
D		Right Leg Panel (with Leveler)	1
E		Leg Support Bar	1

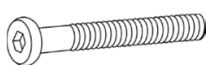
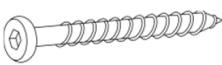



Hardware

Label	Picture	Description	QTY
①		Short Bolt (M8x30mm)	3
②		Long Bolt (M8x50mm)	7
③		Screw (M6x50mm)	3
④		Flat Washer (M8.5/16x2mm)	3
⑤		Allen Key	1

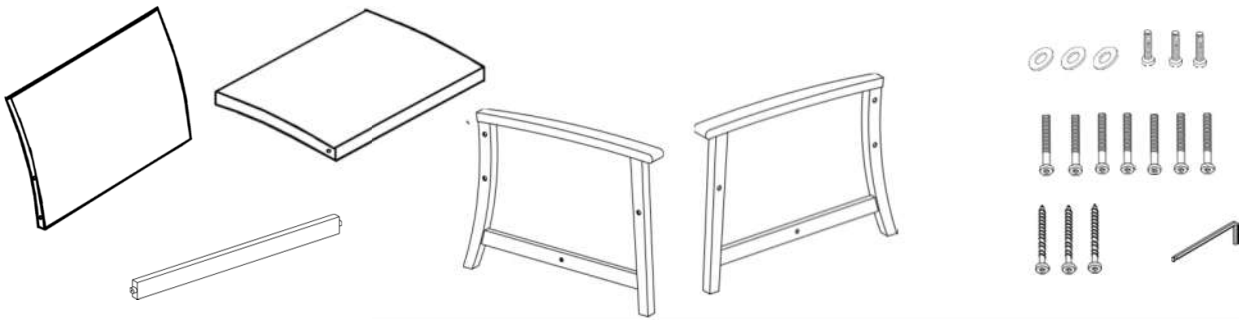
Assembly Preparation

Before Beginning Assembly:



-  • Read instructions, cover to cover-
-  • Have 2 adults on hand for assembly-
-  • Do not assemble on flooring or carpet-
-  • Assemble on a clean non-marring surface (packing foam)-
-  • Save all packaging until finished-

Assembly Steps

Overview

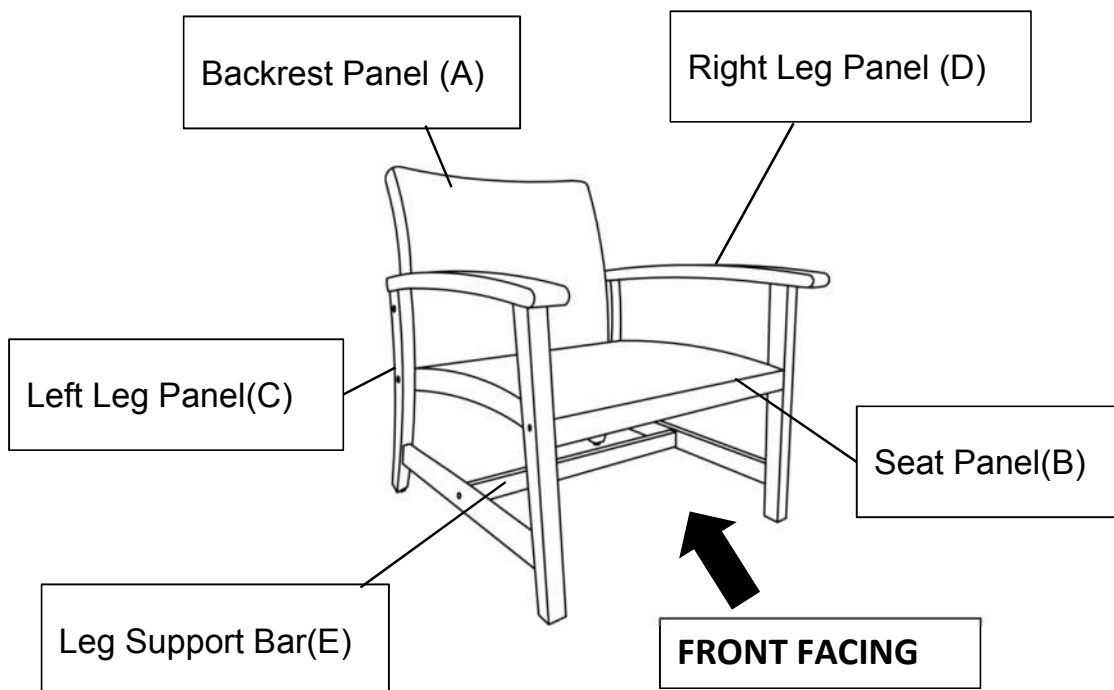

This Chair has multiple parts and may require up to 30 minutes to assemble. To give you an overview of the Chair parts, the above picture is to help you put the various parts into perspective. Please read through the instructions below to familiarise yourself with the parts and steps before assembly.

Step 1

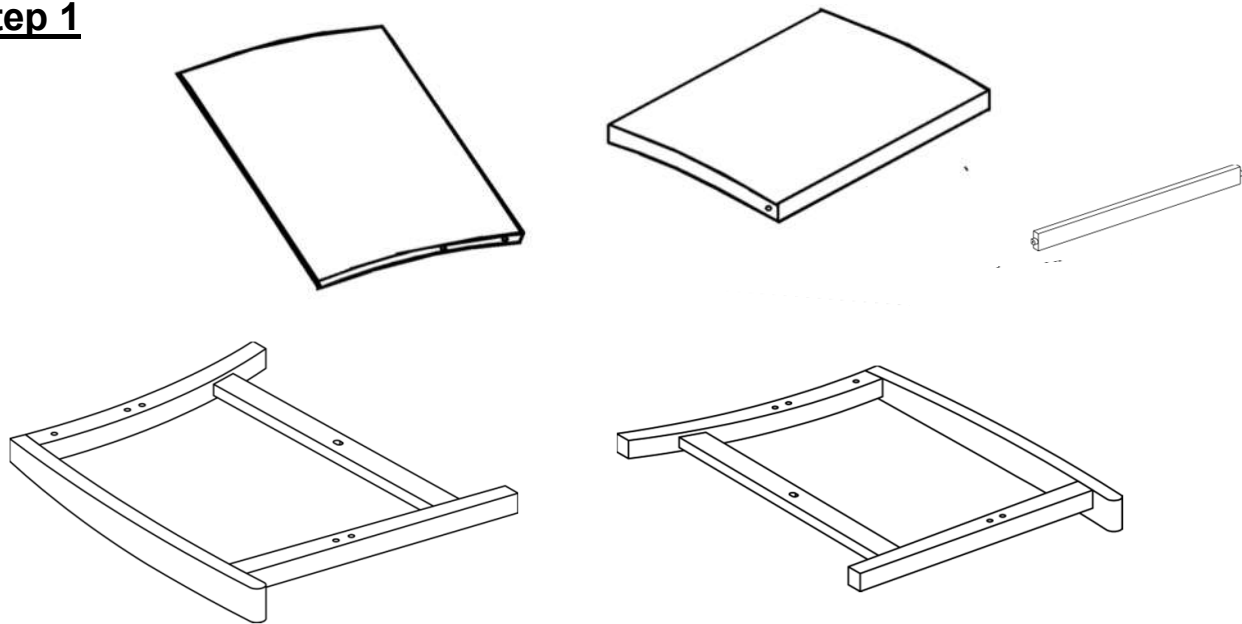

Unpack and place all parts on a clean, non-marring surface.

Step 2

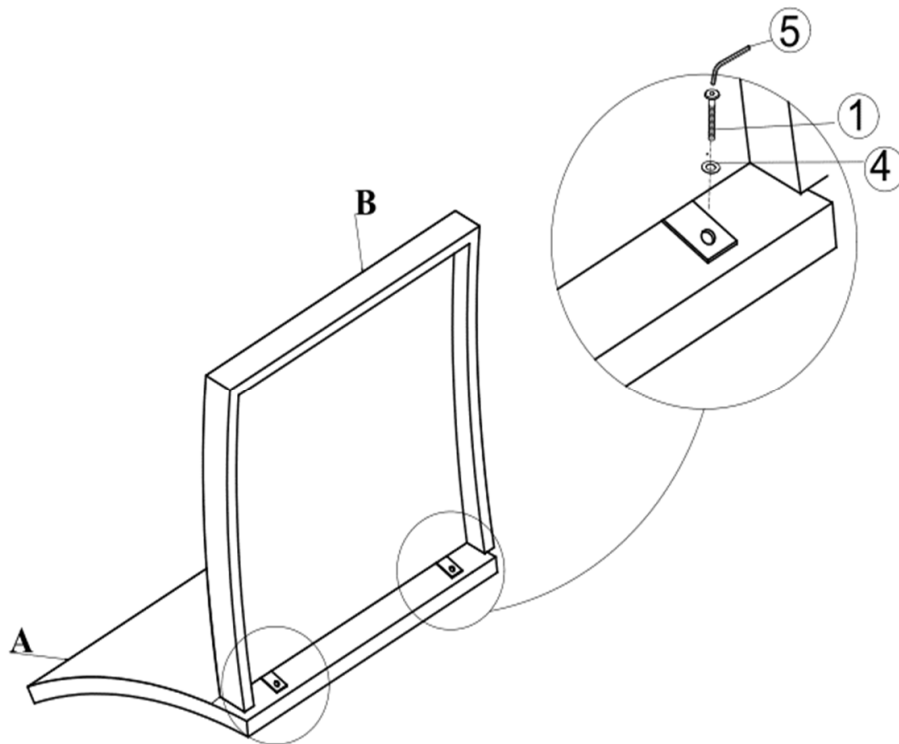

Lay down Backrest Panel (A) then attach Seat Panel (B) to Backrest Panel (A) by using Bolt (①), Flat Washer (④) and secure by Allen Key (⑤)
Do not fully tighten the Bolts.

Step 3

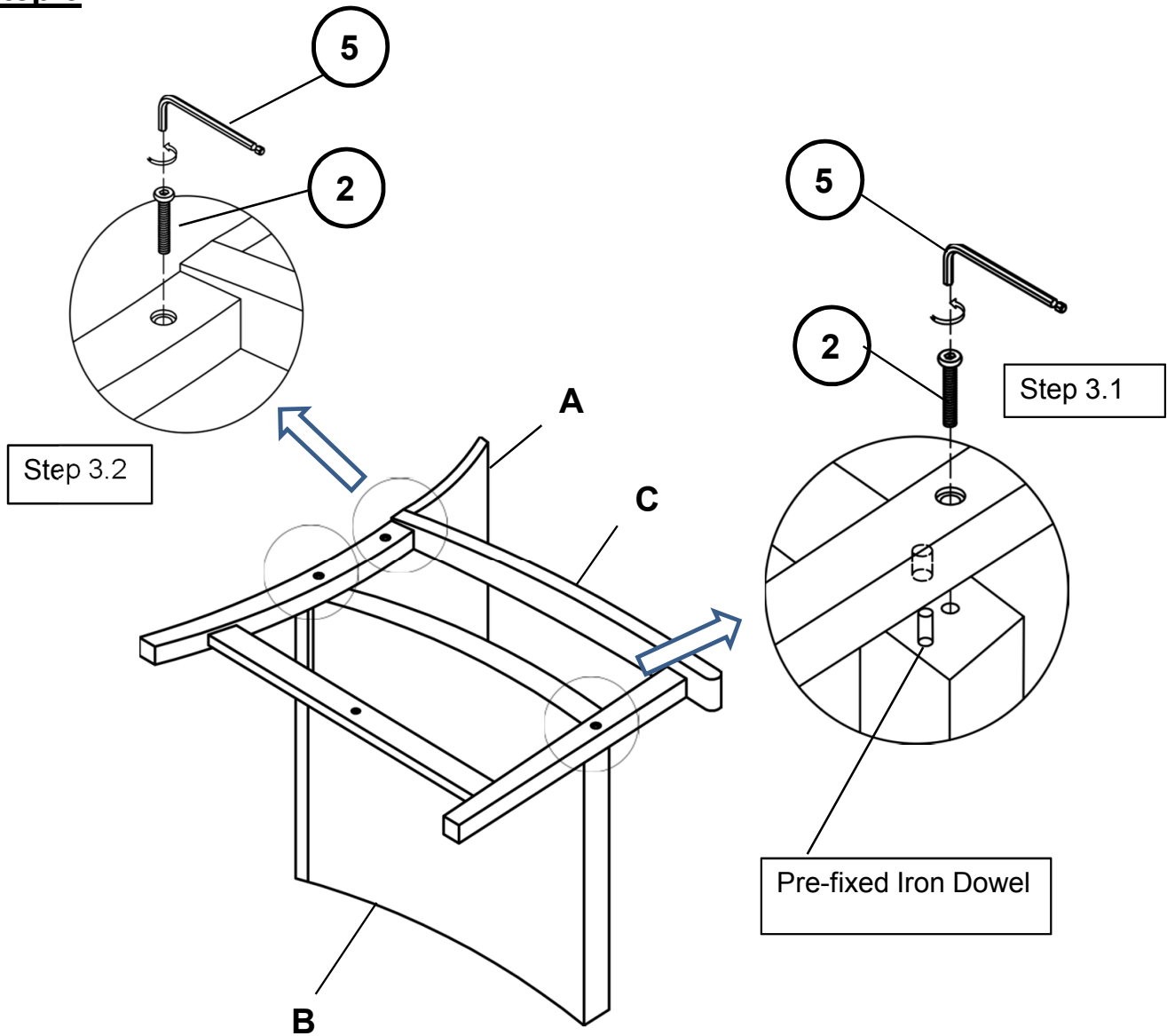

Position housing of Left Leg Panel (C) into pre-fixed iron dowel on Seat Panel (B) as picture

3.1) Secure Left Leg Panel (C) to Seat Frame (B) by using Bolts(②) with Allen Key(⑤)

3.2) Secure Left Leg Panel (C) to Backrest Panel (A) by using Bolts(②) with Allen Key(⑤)

Do not fully tighten the Bolts.

Step 4

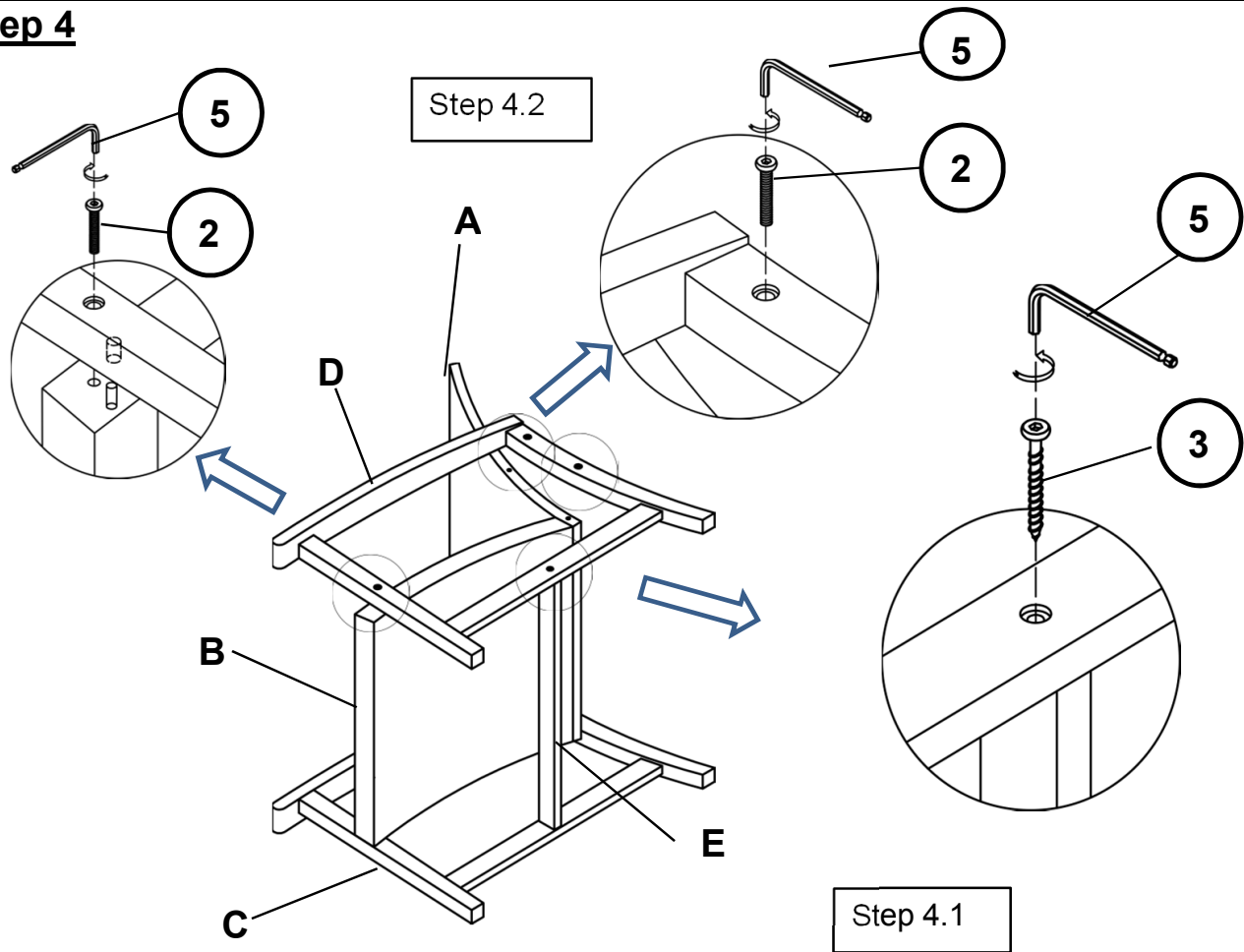

With assistance from your adult partners, turn pre-assemble part in step 3 to the other side

Place Leg Support Bar (E) into housing of Left Leg Panel (C)

Then, position housing of Right Leg Panel (D) into pre-fixed iron dowel on Seat Panel (B) and Leg Support Bar (E) as picture

4.1) Secure Right Leg Panel (D) to Leg Support Bar (E) by using Screw (3) with Allen Key (5)

4.2) Repeat same process in step 3.1 and 3.2 to Secure Right Leg Panel (D) to Backrest (A) and Seat Panel (B)

Do not fully tighten the Bolts, Screws.

Step 5

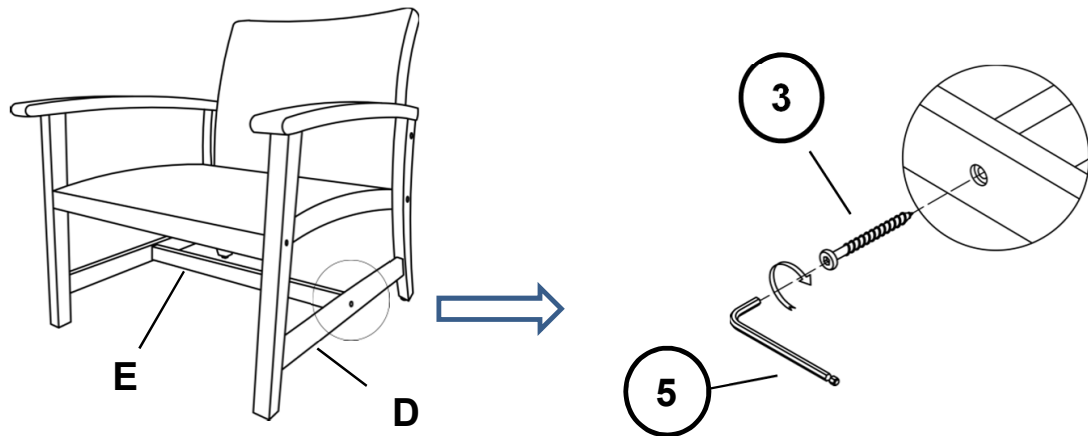

With assistance from your adult partners, turn the Chair back to normal flat ground
Secure Right Leg Panel (D) to Leg Support Bar (E) by using Screw (③) with Allen Key(⑤)
Do not fully tighten the Screw

Step 6

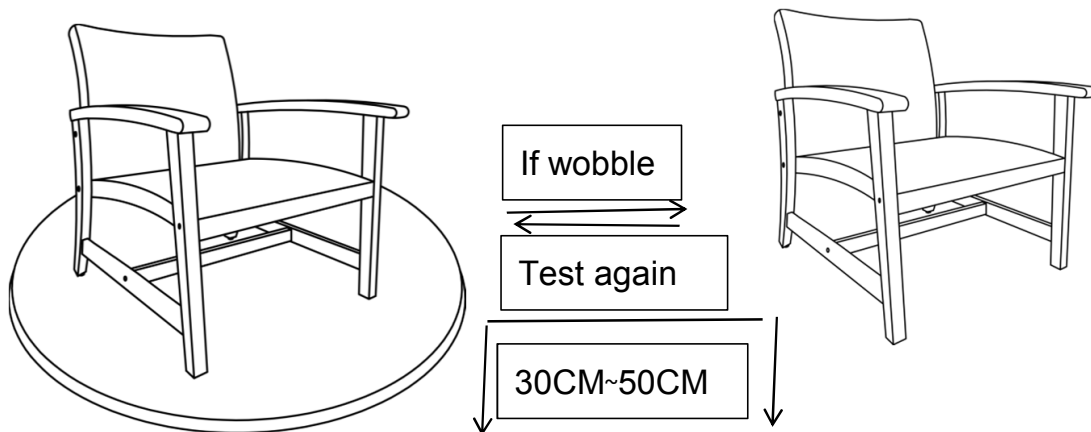

Place the Chair right side up on a LEVEL SURFACE to see if it wobbles.
If it wobbles, lift the Chair to some 30cm to 50cm height from the ground.
Keep your feet and toes well away from the drop zone.
Drop the Chair freely and vertically with the four legs, hitting the ground, at the same time.
This Drop Test will help to ensure that all the Bolts, Screws and gaps all reach full alignment status.
Test again for evenness on a LEVEL SURFACE.
If no wobbles are found, proceed to tighten all the Screws, and Bolts.
CAUTION: When tightening the Screws, and Bolts tighten sequentially. DO NOT tighten any Bolt, or Screw fully and then move towards the next one. This could cause the frame to warp.
If there are still wobbles, loosen the Screws and Bolts and execute this same drop tests.
If the Chair is not stable, it could lead to damage to the product.

Step 7

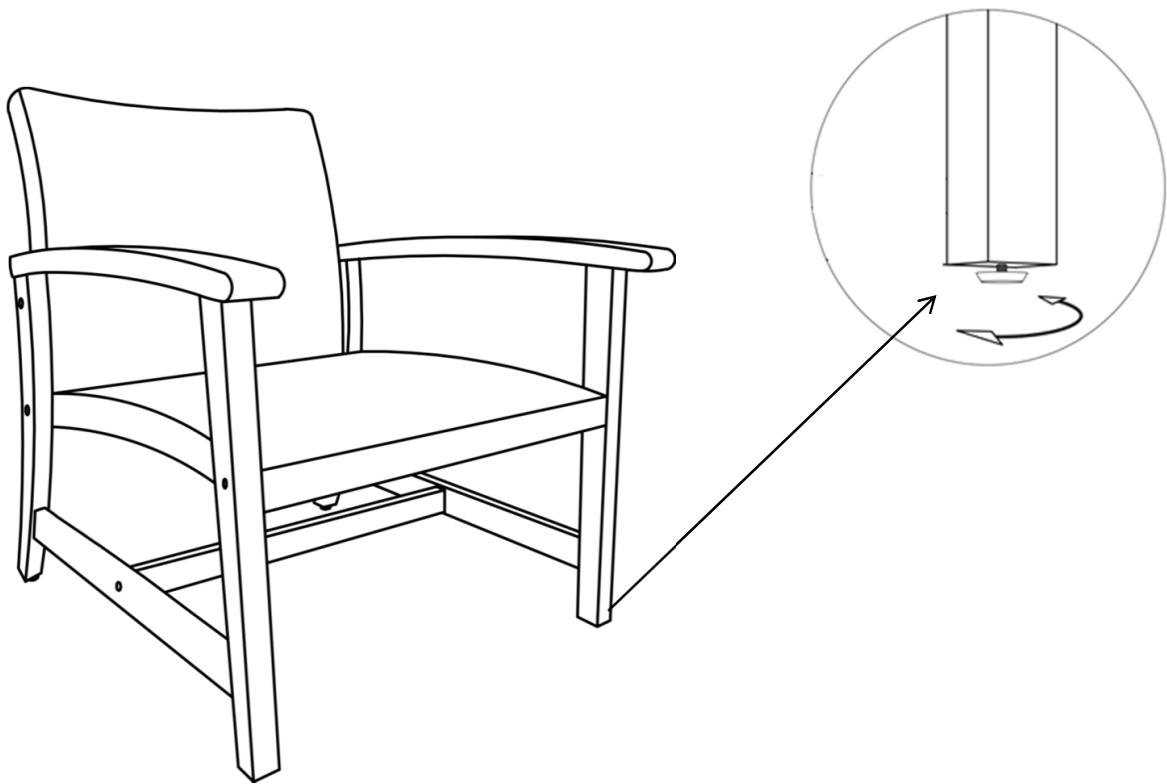



















Your Chair is ready for use.

Please use adjustable foot for uneven floors.

This Chair can only be used on a flat, level surface.

Care & Maintenance

-   ● Do not put hot items directly on furniture surface
 -   ● Do not clean furniture with harsh cleansers or polish.
 -   ● To obtain the longest lifespan of your outdoor products, minimizing exposure to direct sunlight is recommended.
 -   ● Children should not climb or jump on the furniture.
 -   ● Do not write on furniture without a padded barrier to protect the surface.
 -   ● To obtain the longest lifespan of your outdoor products, avoid extended and lengthy exposure to rain, snow, and direct sunshine. Whenever possible cover the product and /or place under patio or awnings.
 -   ● Not for commercial use. For residential use only .
 -   ● Stains may be removed with mild soap solution and damp cloth.
-
-   ● Dust and pick-up spills using a clean, non-colored, lint-free cloth .