

DAYBED

ASSEMBLY INSTRUCTIONS

Before assembling your Daybed, please read through these instructions carefully. Familiarize yourself with the different parts.

ATTENTION! If you receive a damaged or defective item, please contact us.

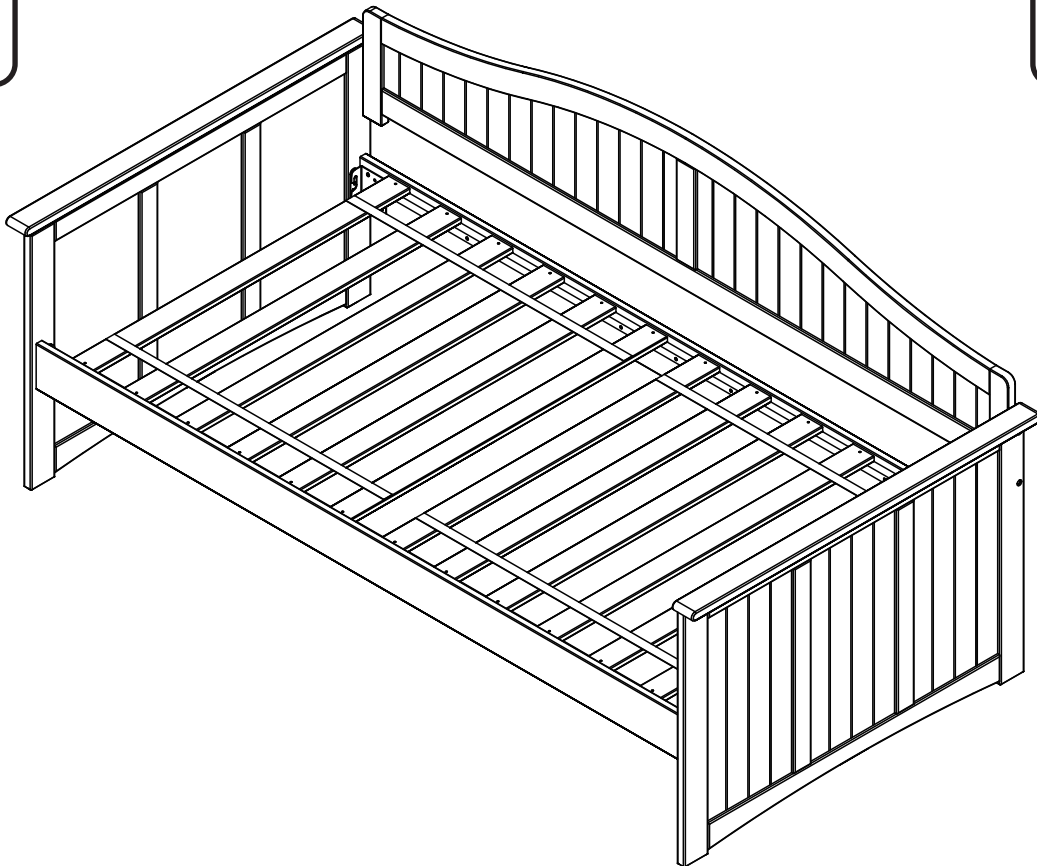
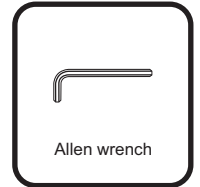

HARDWARE

NOTE: WE INCLUDE SPARE HARDWARE IN CASE DAMAGE OCCURS DURING ASSEMBLY.

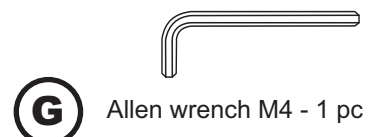
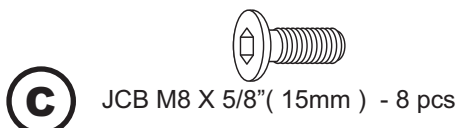
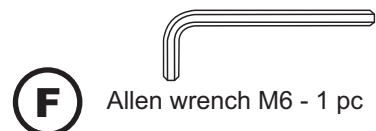
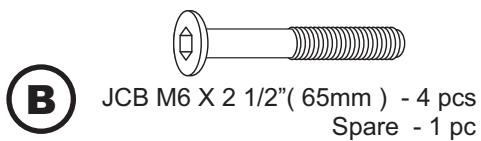

PARTS LIST

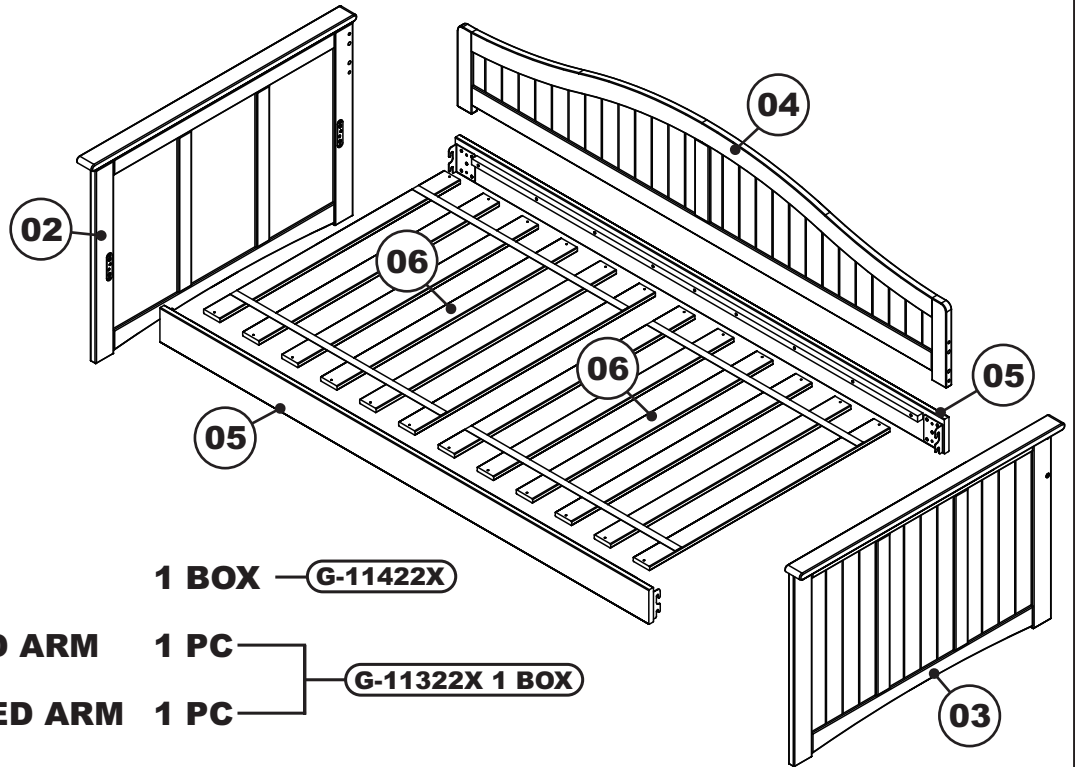

| | | | |
|-----------|--------------------------|--------------|-----------------------|
| 01 | HARDWARE | 1 BOX | G-11422X |
| 02 | LEFT DAYBED ARM | 1 PC | G-11322X 1 BOX |
| 03 | RIGHT DAYBED ARM | 1 PC | |
| 04 | BACK PANEL | 1 PC | G-11422X 1 BOX |
| 05 | FRONT / BACK RAIL | 2 PCS | |
| 06 | SLAT KIT | 2 SET | |

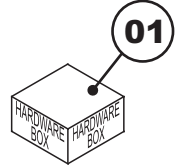

Step 1

Attach the back panel (04) to the left and right daybed arm (02)(03), using wood dowels (A), JCB M6 X 2 1/2" (B) and barrel nut (E). Tighten with the Allen wrench (G).

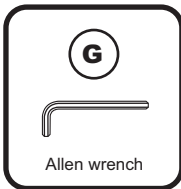
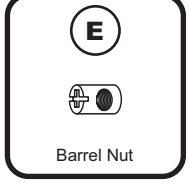
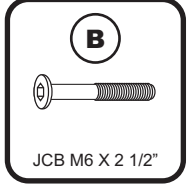
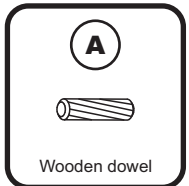
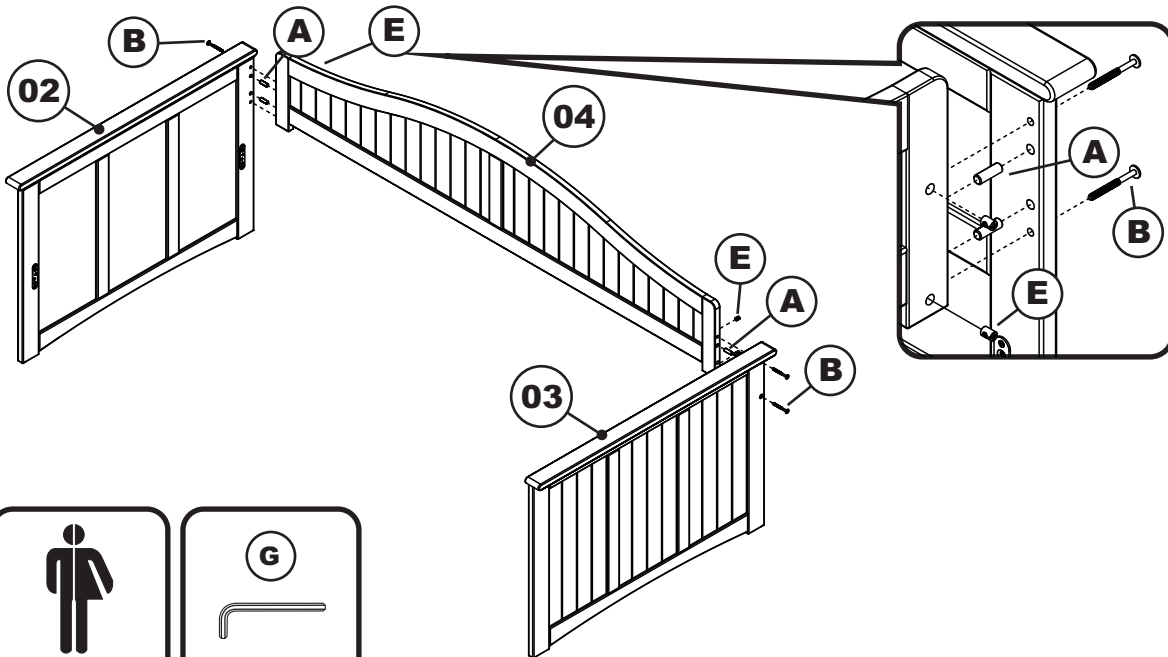

Step 2

Attach the front and back rail (05) to the Daybed arms as shown, using JCB M8 X 5/8" (C). Tighten with the Allen wrench (F).

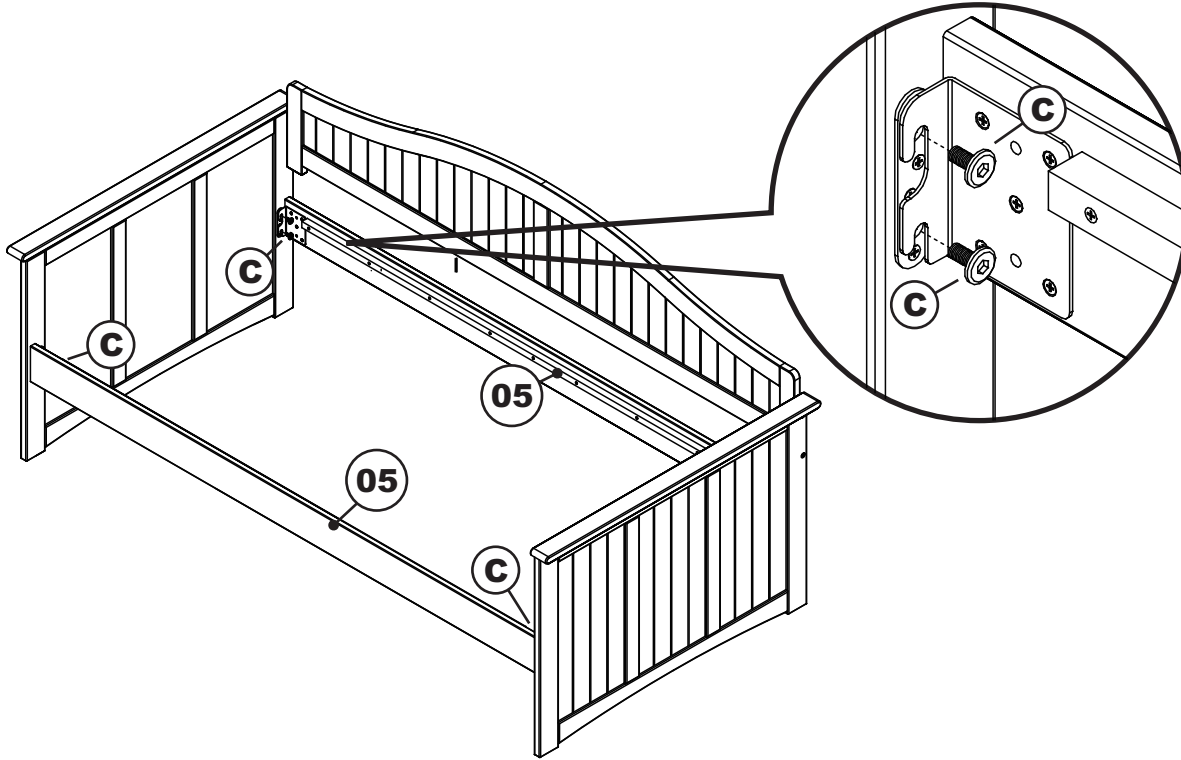

Adult assembly

C



JCB M8 X 5/8"

F



Allen wrench

Step 3

Lay the slat kit (06) onto the rail assembly as shown, using wood screw (D). Tighten with the Phillips head screw driver (Customer supplied).

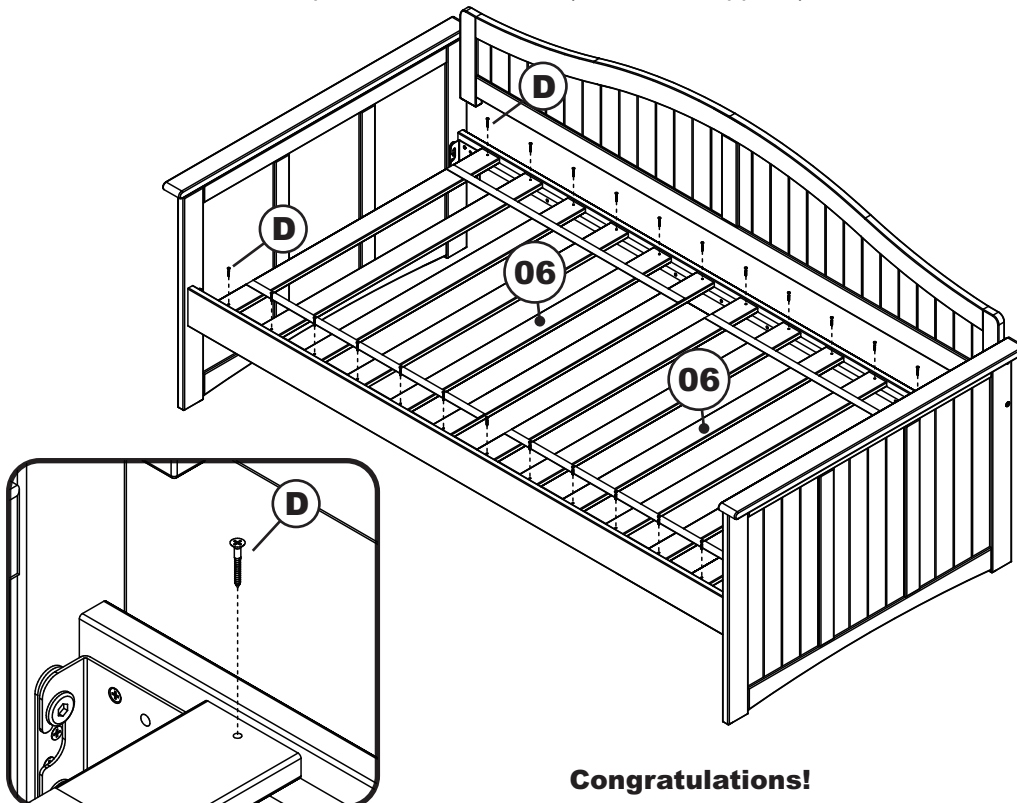

Adult assembly

D

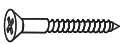

Wood screw

Phillips screwdriver



Customer supplied

Congratulations!

Your Daybed is now ready for use.

We recommend that you periodically check that all screws are tight and all parts are secure to ensure lasting safety.