

# ASSEMBLY | INSTRUCTION

# INSTRUCTIONS DE MONTAGE

---

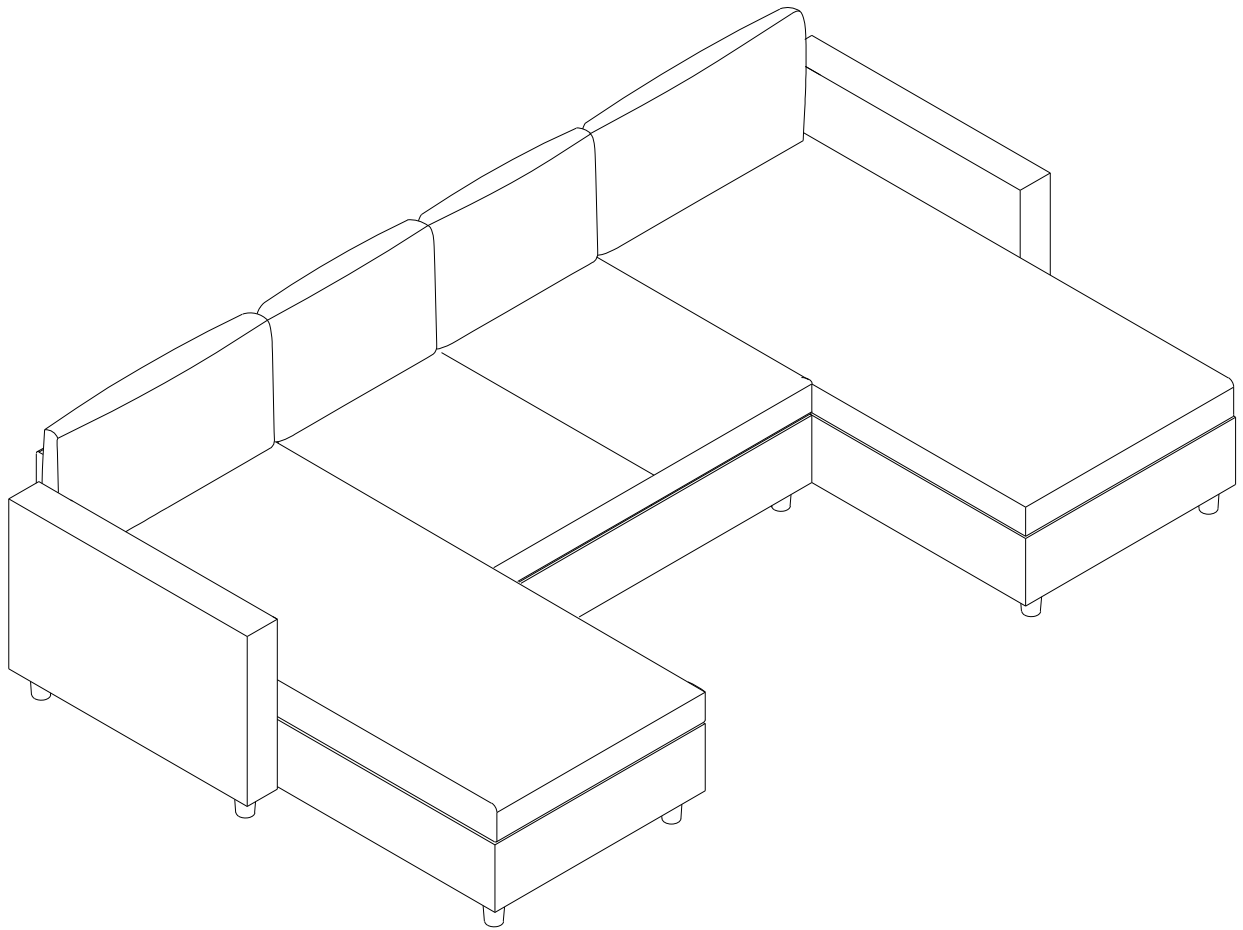

# PARTS LIST(LISTE DES PIÈCES)

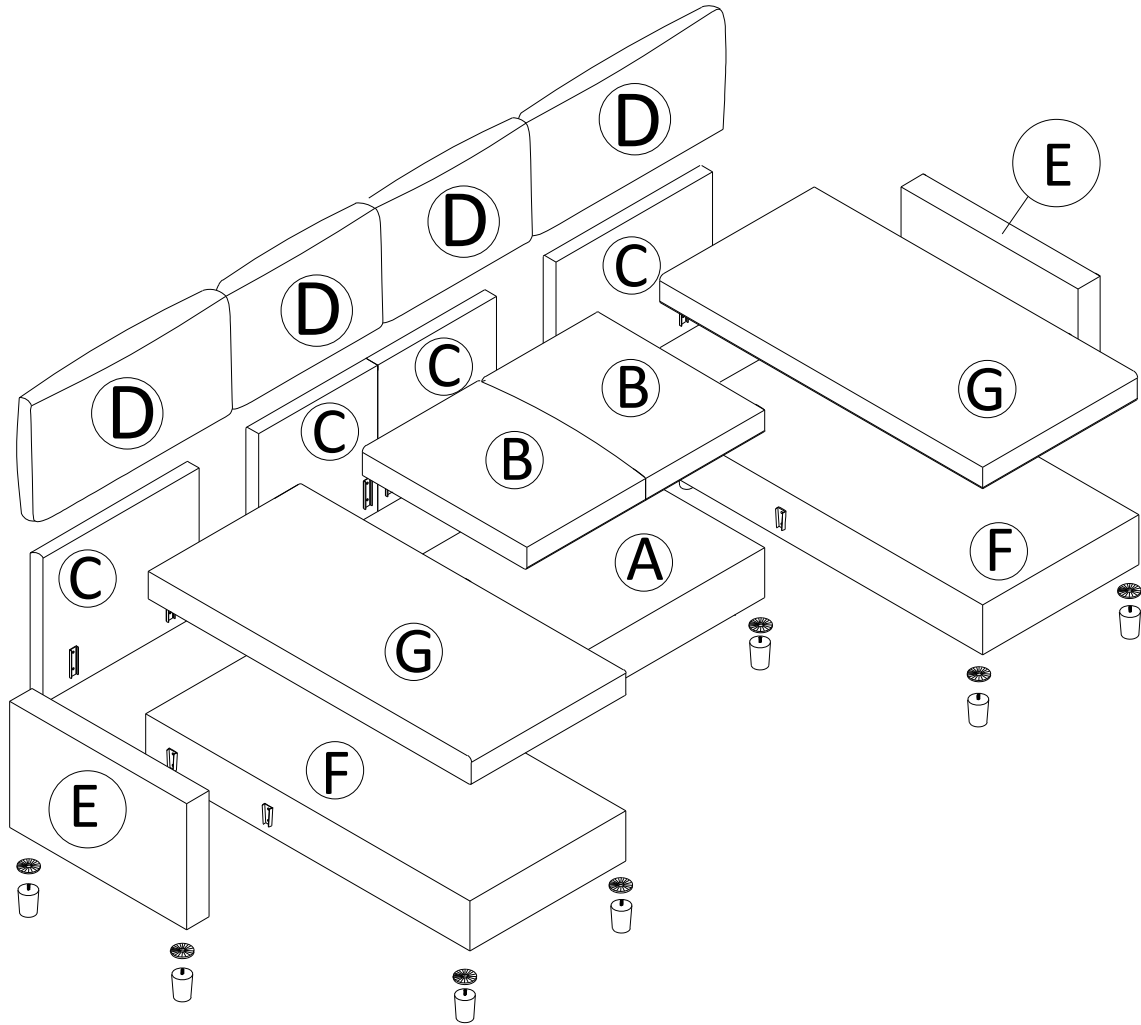

(A)

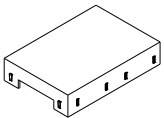

Loveseat Body  
(Corps de canapé  
deux places)

X 1PC

(B)

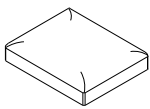

Seat Cushion  
(Coussin de siège)

X 2PCS

(C)

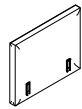

Backrest Frame  
(Cadre de dossier)

X 4PCS

(D)

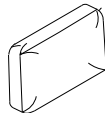

Back Cushion  
(Coussin de dossier)

X 4PCS

(E)

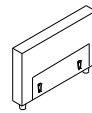

Arm  
(Accoudoir)

X 2PCS

(F)

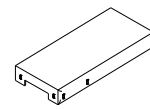

Seat Frame  
(Cadre de siège)

X 2PCS

(G)

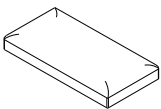

Seat Cushion  
(Coussin d'assise)

X 2PCS

(1)



Legs  
(Pieds)



X 16PCS



(2)

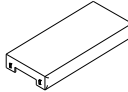
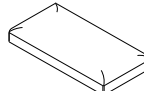
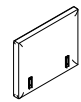
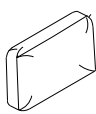

Plastic Gasket  
(Joint en plastique)

X 16PCS

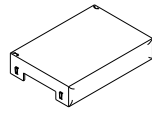
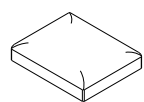
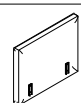
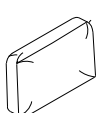
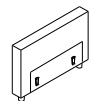
<b>PARTS LIST (LISTE DES PIÈCES)</b>			
<b>NO</b>	<b>DESCRIPTION</b>	<b>SKETCH</b>	<b>QTY</b>
<b>F</b>	Seat Frame (Cadre de siège)		<b>2</b>
<b>G</b>	Seat Cushion (Coussin d'assise)		<b>2</b>
<b>C</b>	Left backrest Frame (Cadre de dossier gauche)		<b>2</b>
<b>D</b>	Back Cushion (Coussin de dossier)		<b>2</b>
<b>1</b>	Legs (Jambes)		<b>8</b>

<b>PARTS LIST (LISTE DES PIÈCES )</b>			
<b>NO</b>	<b>DESCRIPTION</b>	<b>SKETCH</b>	<b>QTY</b>
<b>A</b>	Left Loveseat Frame (Cadre de canapé d'amour gauche)		<b>1</b>
<b>B</b>	Seat Cushion (Coussin de siège)		<b>2</b>
<b>C</b>	Backrest Frame (Cadre de dossier)		<b>2</b>
<b>D</b>	Back Cushion (Coussin de dossier)		<b>2</b>
<b>E</b>	Arm (Accoudoir)		<b>2</b>
<b>1</b>	Legs (Jambes)		<b>8</b>
<b>2</b>	Plastic Gasket (Joint en plastique)		<b>16</b>

Step 1

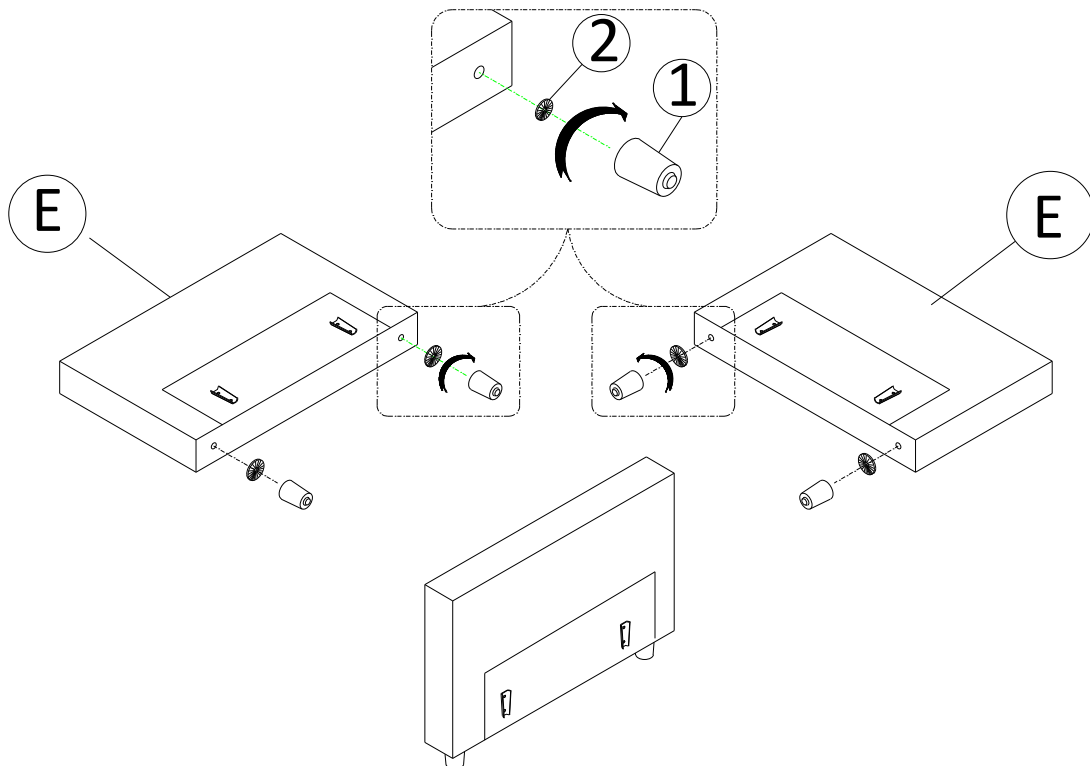

Step 2

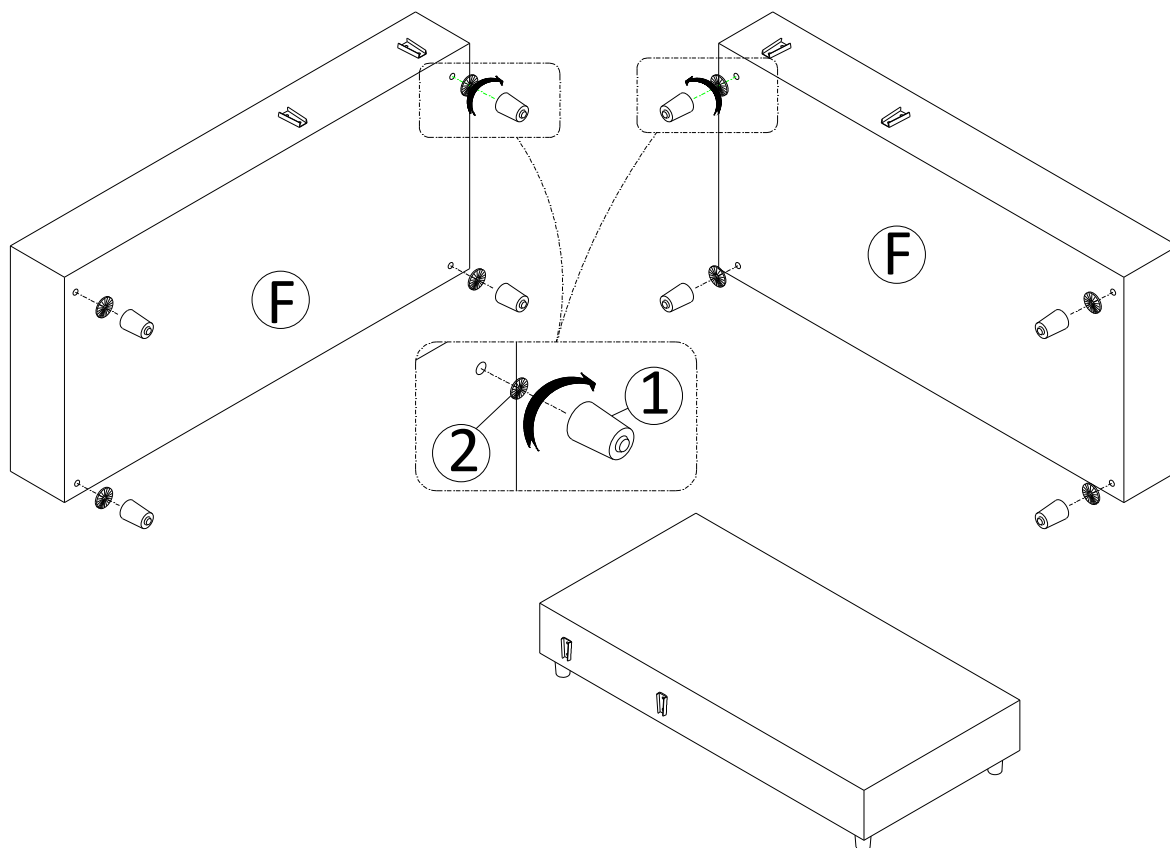

**Step 3**

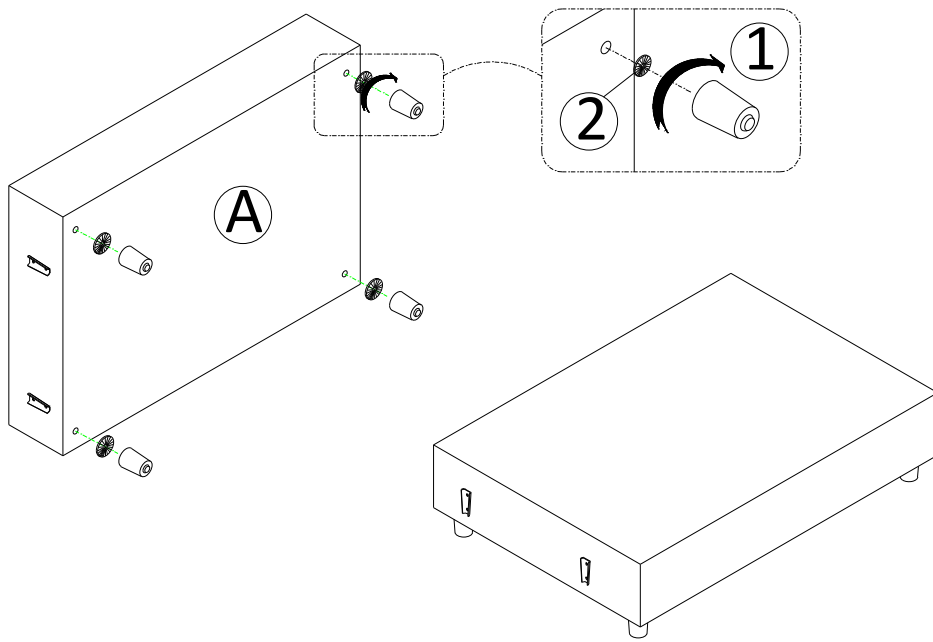

**Step 4**

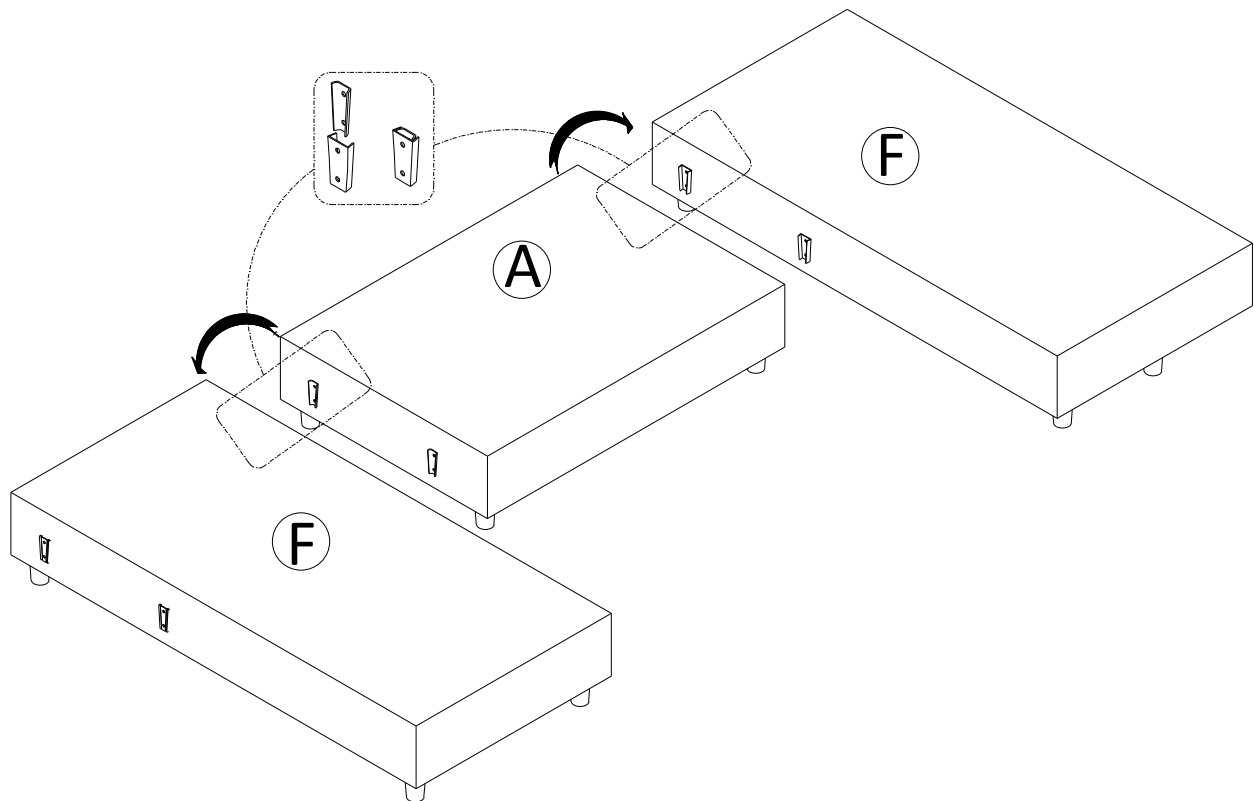

Step 5

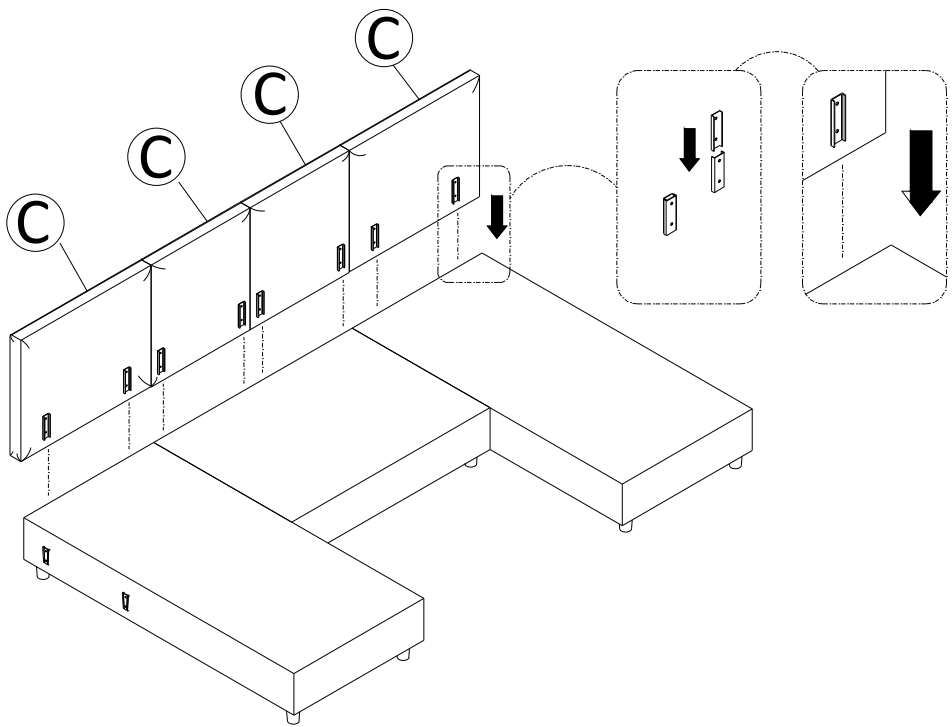

Step 6

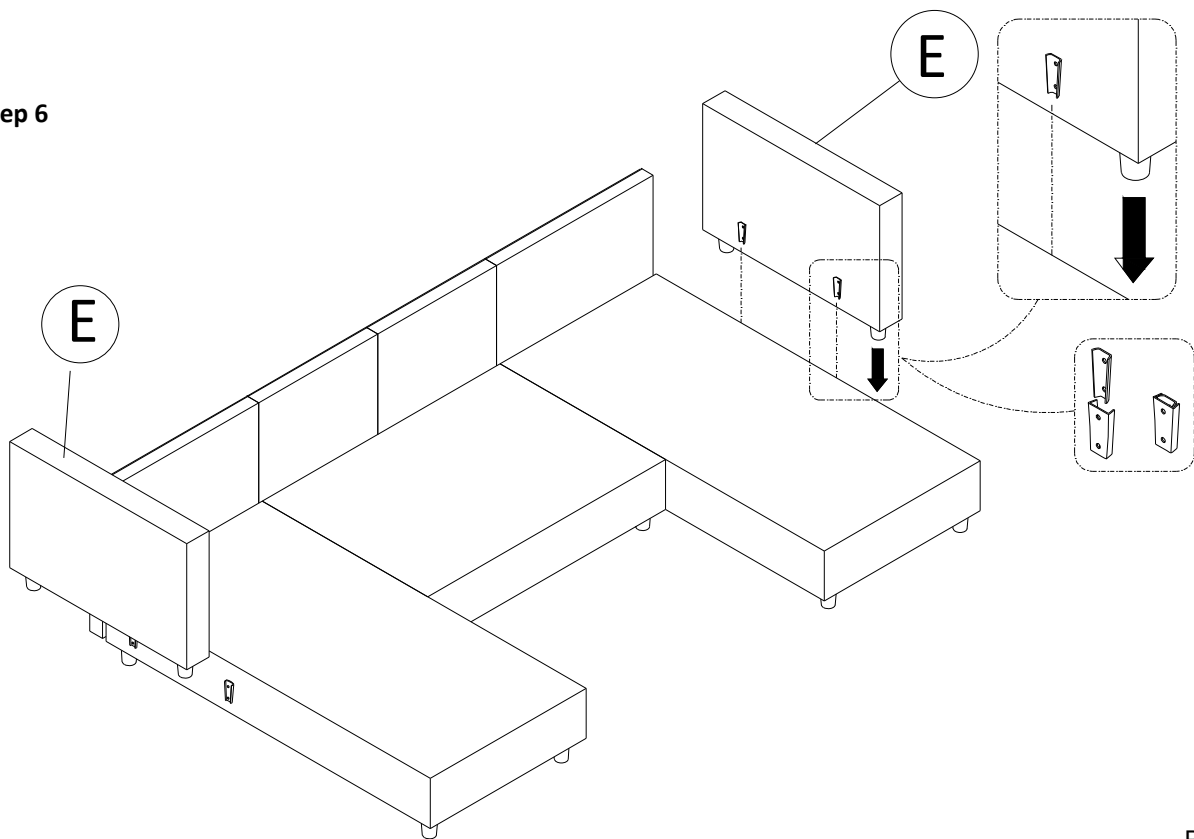

Step 7

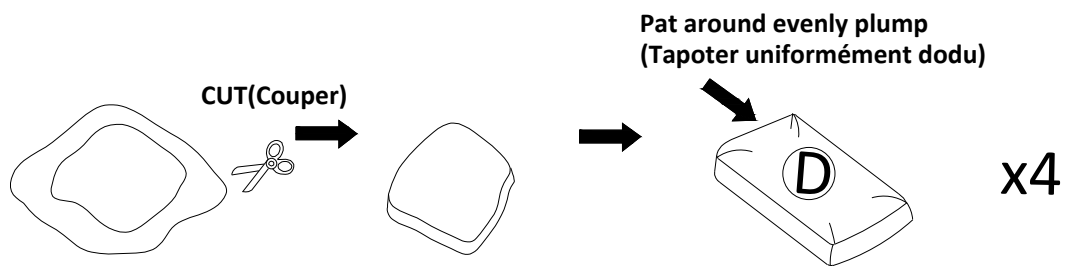
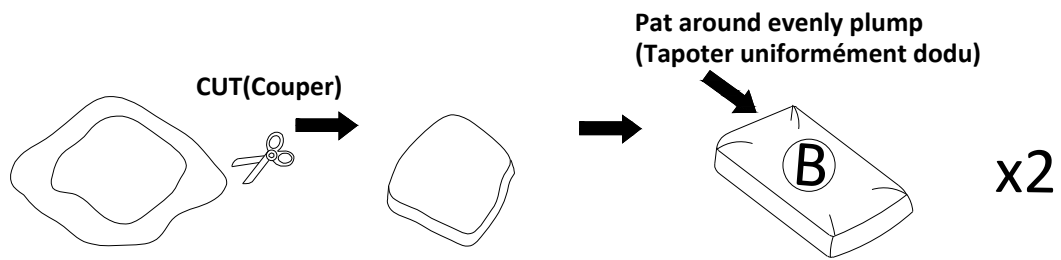
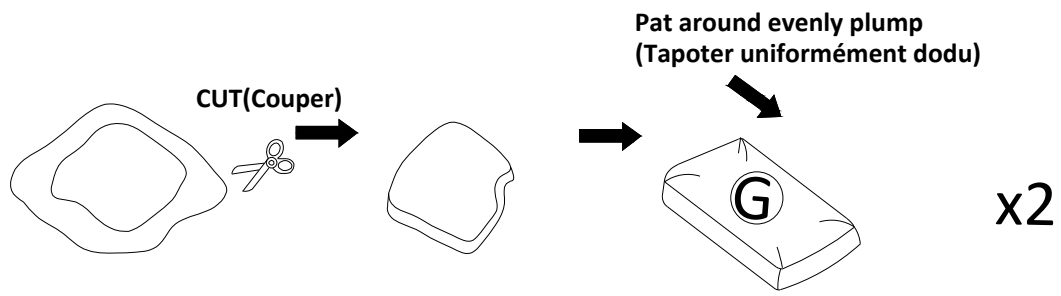

Step 8

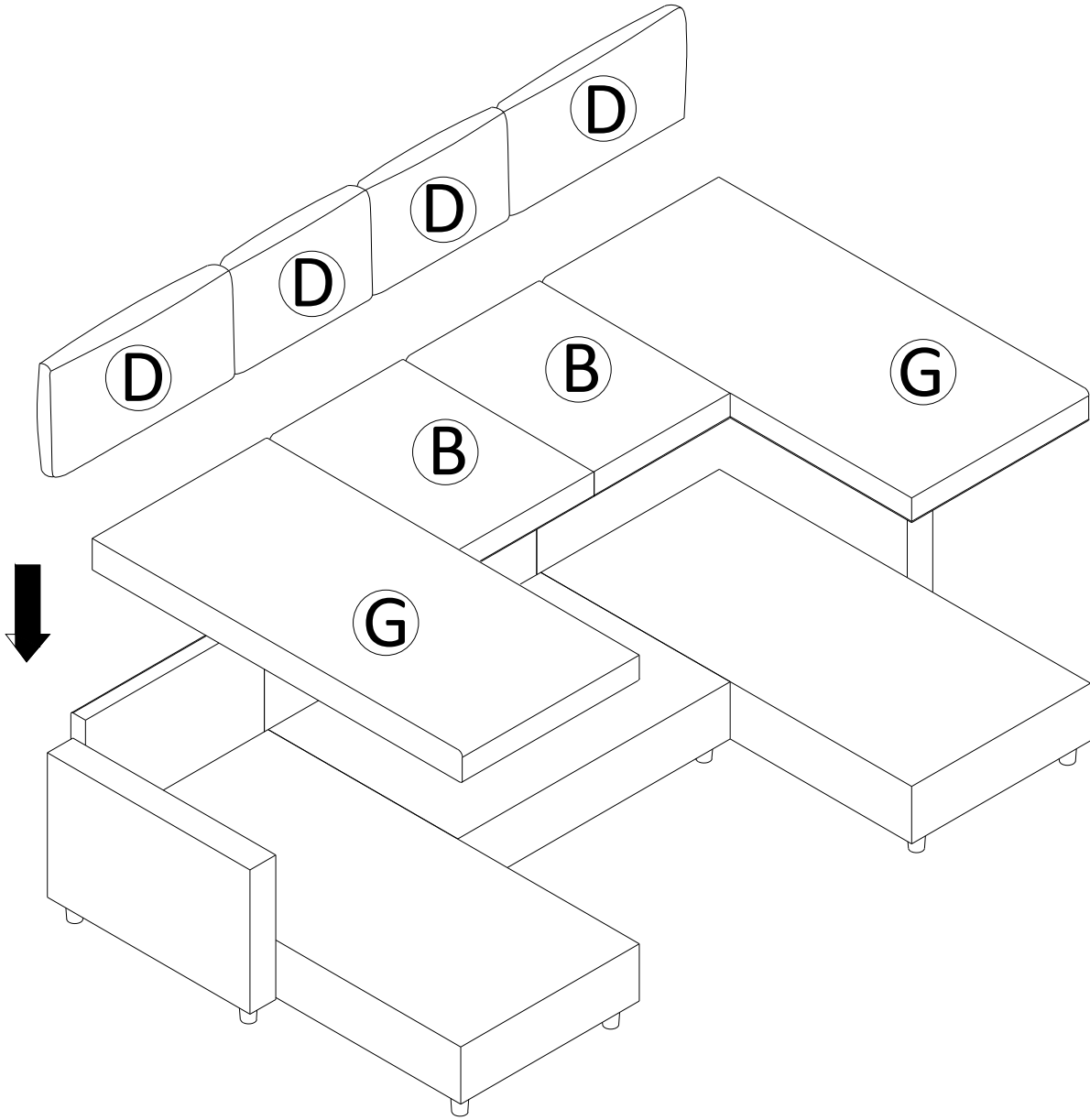

## Helpful Hints(Conseils utiles)

- Move your new furniture carefully, with two people lifting and carrying the unit to its new location.  
(Déplacez vos nouveaux meubles avec précaution, avec deux personnes soulevant et transportant l'unité jusqu'à son nouvel emplacement.)
- Your furniture can be disassembled and reassembled to move.  
(Vos meubles peuvent être démontés et remontés pour le déplacement.)
- Clean the product with a soft damp cloth. DO NOT use harsh chemicals or abrasive cleaners.  
(Nettoyez le produit avec un chiffon doux humide. N'utilisez PAS de produits chimiques agressifs ou de nettoyeurs abrasifs.)

### COMPLETED(Terminé)

