

Assembly Instruction

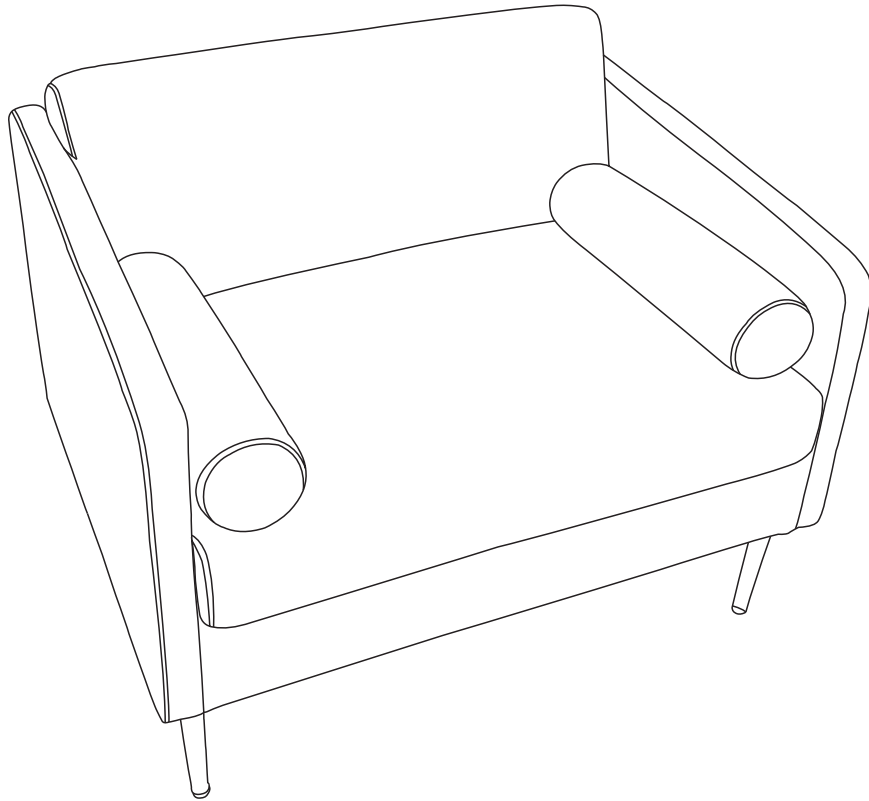

Attention: Do not open the compression bag if you are not satisfied with the product







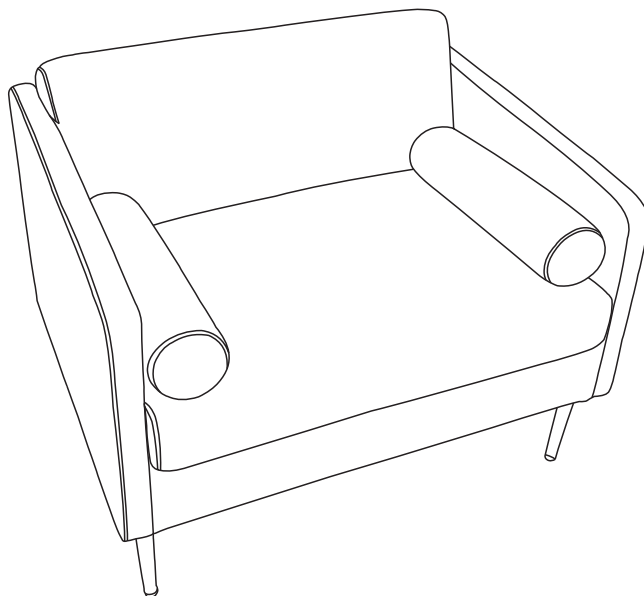
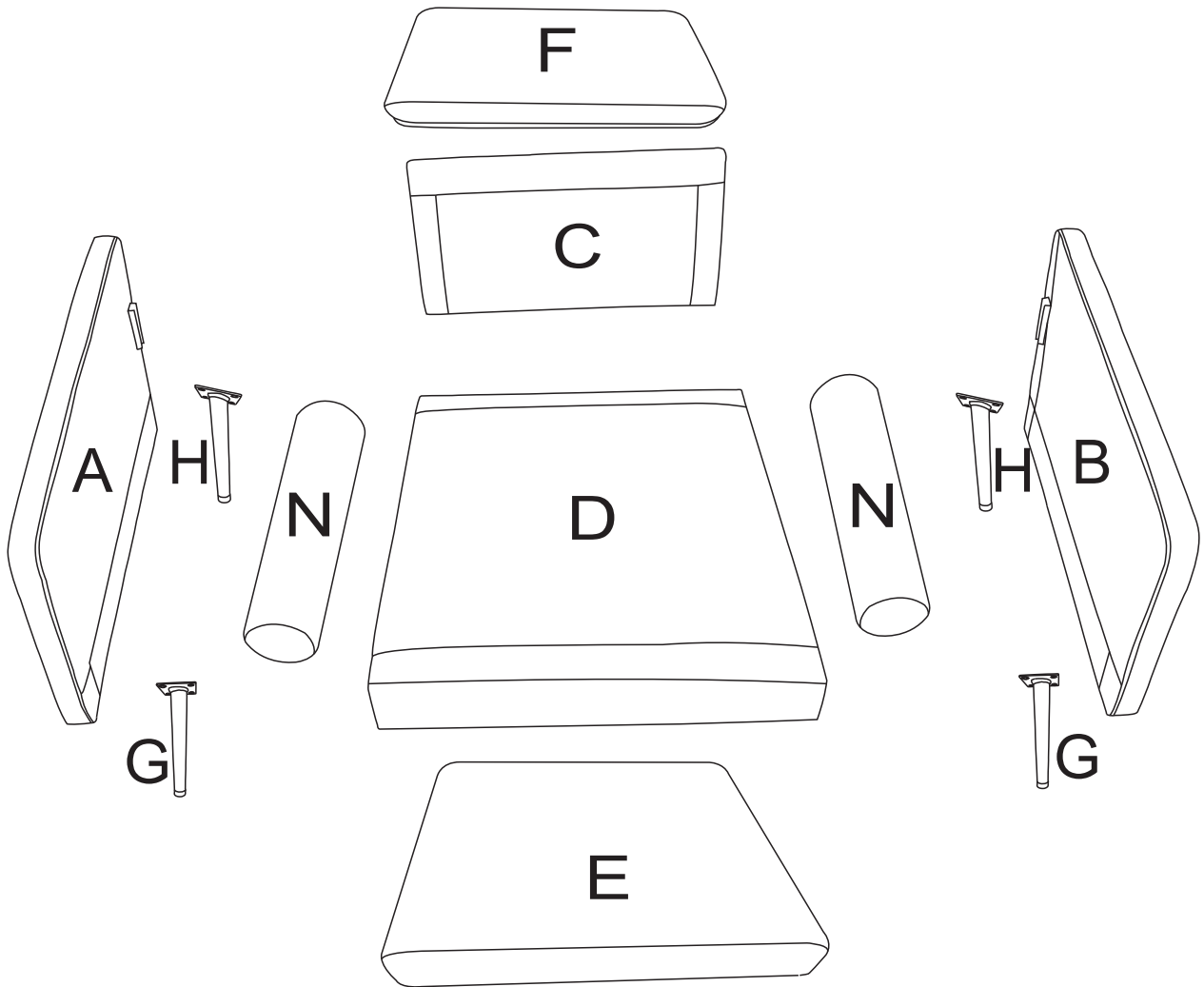

Thank you for your purchase.

If you have difficulty with assembly or find a part is missing or damaged, please don't hesitate to contact us for solution.

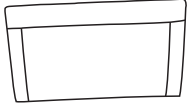
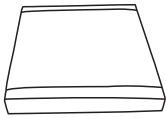
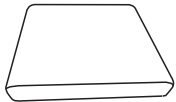
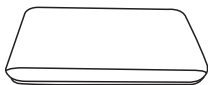
Customer Service team will work hard to put a smile back on your face.

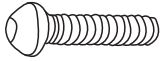
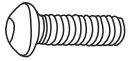
Components

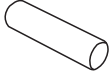

NO	PARTS	QTY	DESCRIPTION
A		1 PC	Left Arm-rest frame
B		1 PC	Right Arm-rest frame
C		1 PC	Back frame
D		1 PC	Seat frame
E		1 PC	Seat Cushion
F		1 PC	Back Cushion
G		2 PCS	Front Leg
H		2 PCS	Back Leg
I		4 PCS+1	M8*60mm Screw
J		16 PCS+2	M6*25mm Screw
K		4 PCS+1	M8*12 Spring Washer
L		4 PCS+1	M8*22 Flat Washer
M		1 PC	Allen Key
N		2 PCS	Round pillow

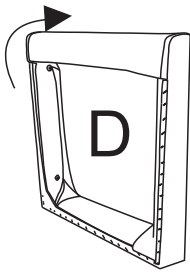
STEP 1

Open the seat and take out the accessory



C*1



F*1



G*2



H*2

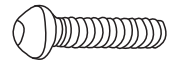

I*4+2

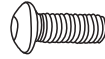

J*16+2



K*4+1



L*4+1



M*1

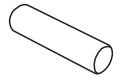

N*2

STEP 2

Connect Seat frame D to handrail A with screw I

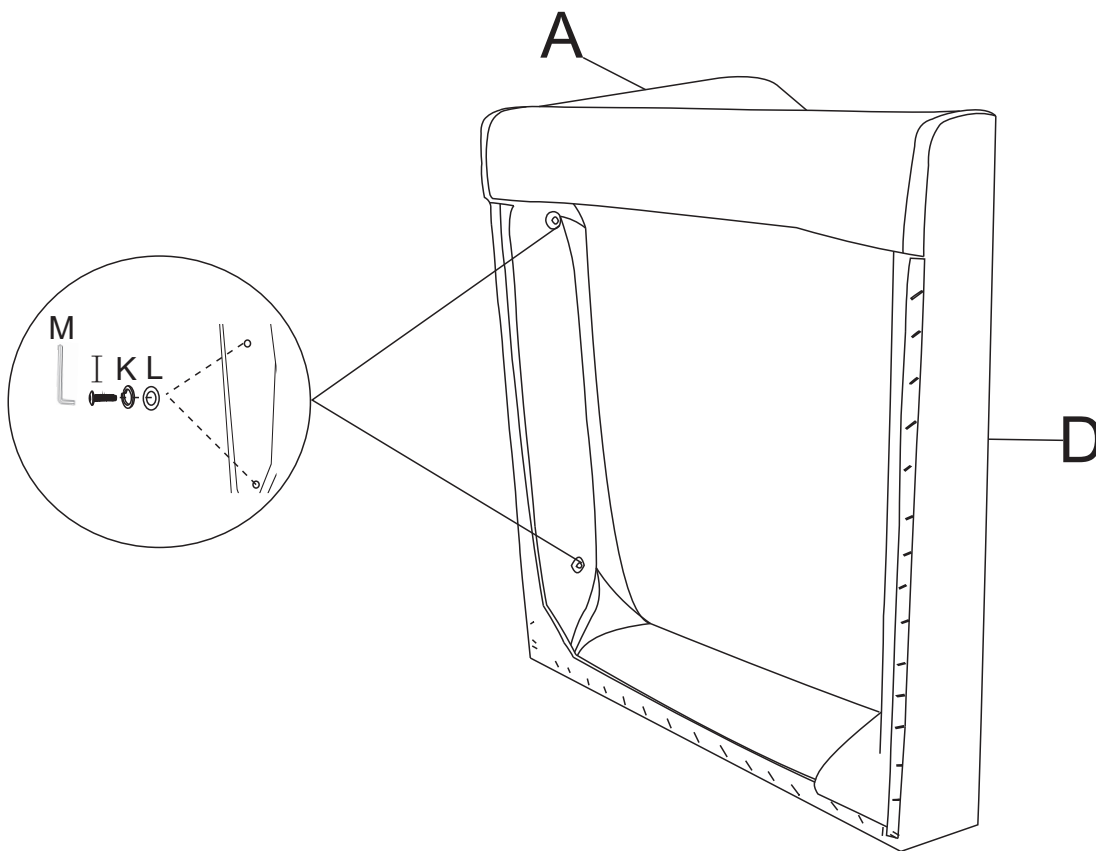

STEP 3

Connect Seat frame D to handrail B with screw I

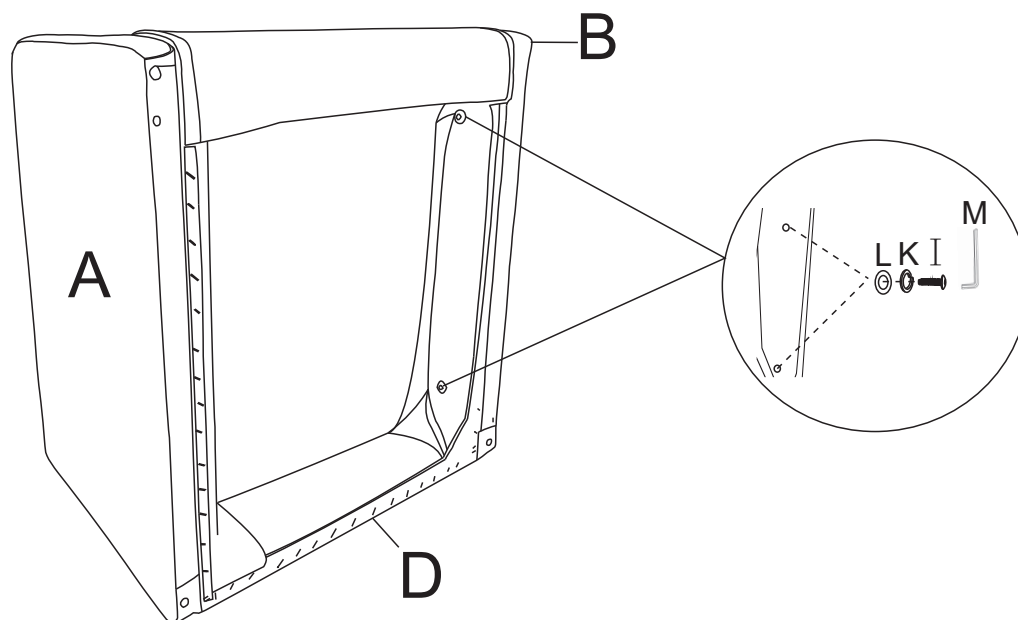

STEP 4

put in C, Link as shown

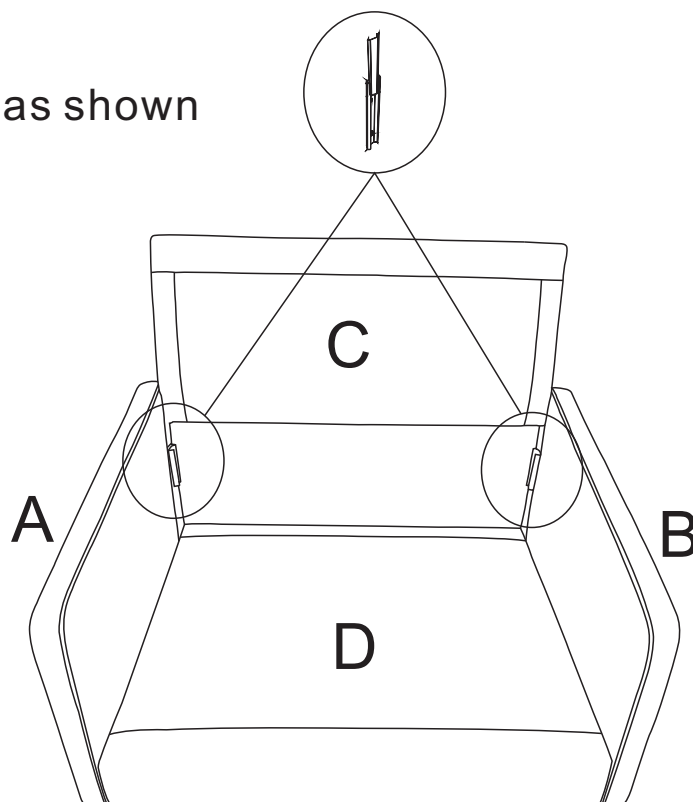

STEP 5

Secure the Leg G/H and Seat frame D with screw J
(Attention:Distinguish between front and back leg)

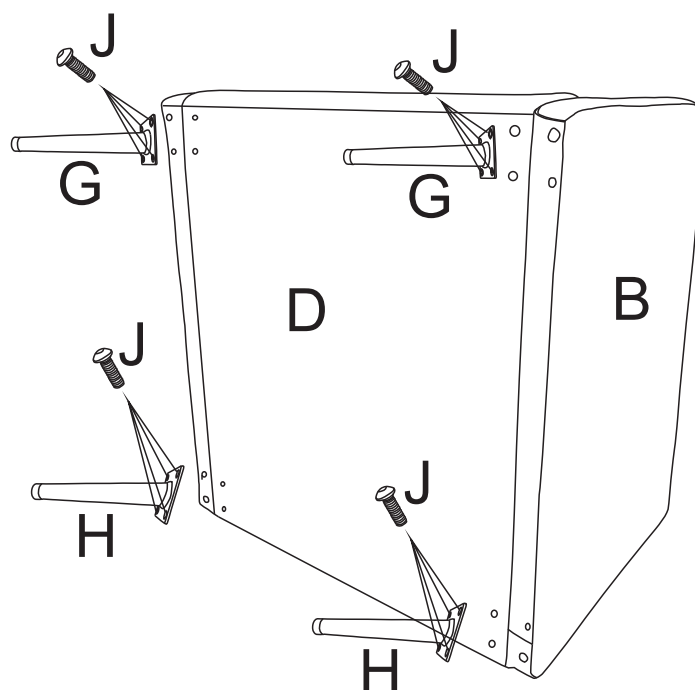

STEP 6

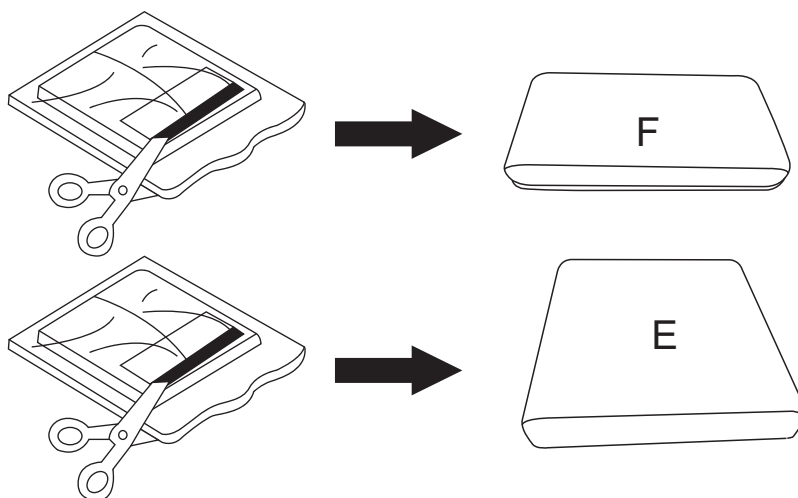

1. Cut open the compression package and remove the seat cushion and back cushion
2. Compression package after cutting, after standing for 24 hours, more comfortable

STEP 7

Have cushion F and E placed respectively

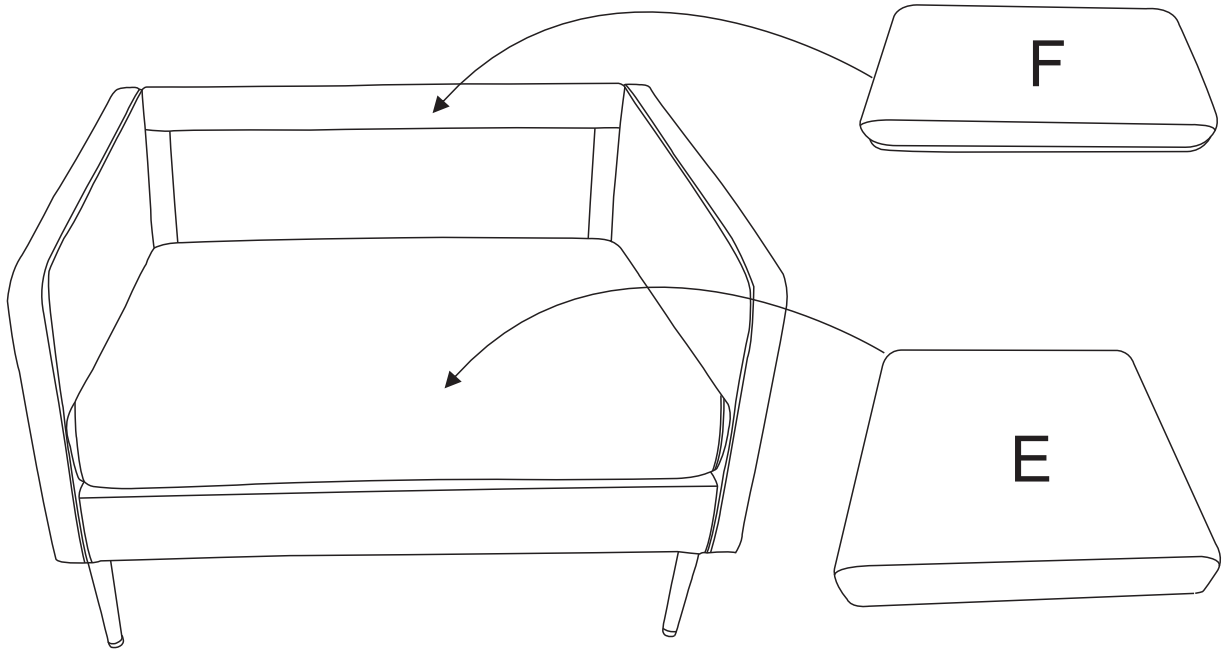

STEP 8

Having N placed

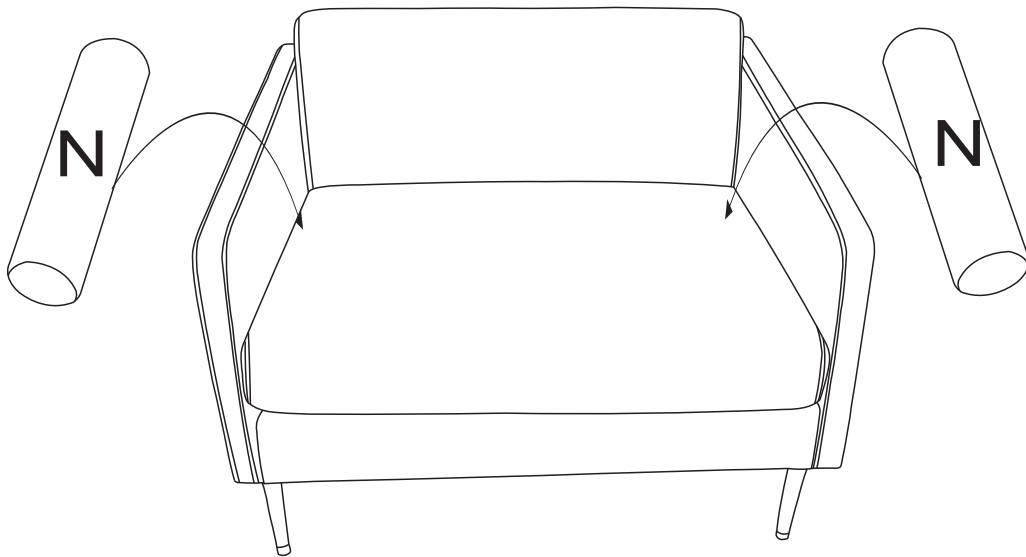

STEP 9

Well done!

