

Convertible Sofa Sleeper

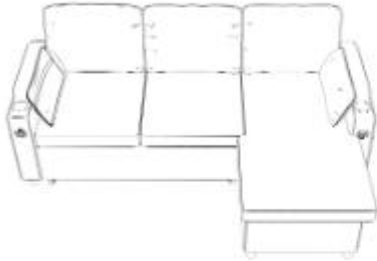

**L shaped sofa
(Right Facing)**

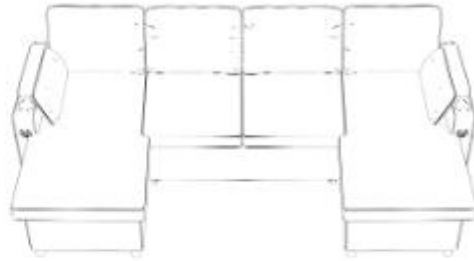

U shaped sofa

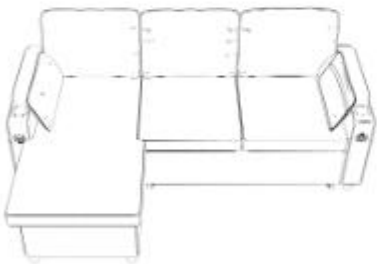

**L shaped sofa
(Left Facing)**

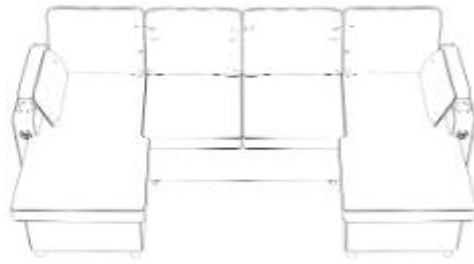

U shaped sofa

PRE-ASSEMBLY INFORMATION



TWO PERSON ASSEMBLY



UP TO 30 MINUTES FOR ASSEMBLY



ONE SEAT WEIGHT LIMITATION:300LB



VACUUM COMPRESSION

Thank you for choosing our product. To ensure safe and satisfactory use of this product, please carefully read the below instructions before assembly.

HOW MANY PACKAGES INCLUDED?

L shaped sofa: 2 Boxes (A/B)

U shaped sofa: 3 Boxes (A/B/C)

ASSEMBLY REQUIREMENT

2 PERSON ASSEMBLY | 20-30 MINUTES ASSEMBLY TIME (APPROXIMATE)













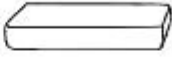



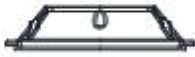
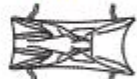
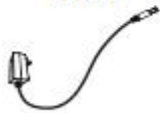

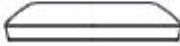

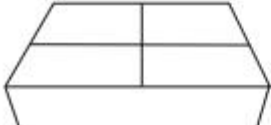



ASSEMBLY PREPARATION

1. Remove all packaging materials, hardware and parts from the carton.
2. Refer to Parts List and ensure they are complete before you start assembling.
3. Place all components on a clean, flat and soft surface (e.g. carpet or rug) to prevent parts from getting scratched.







Catalogue

Part List.	3
Sofa Legs Assembly.	5
Install the Swift-loks on sofa chaise	6
Connect Sofa Base & Armrest	9
Connect Backrest Frame and Cover it.	13
Insert Backrest Into Armrest.	15
Footrest Assembly.	16
How to replace USB.	21

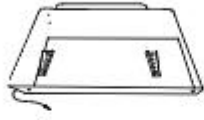









Box A Parts List

A Sofa Base  1pc	D Armrest(D)  1pc	E Seat Cushion  2pcs	G Backrest Pillow  1pc
H Throw Pillow  1pc	K Backrest Cover(K)  1pc	L Footrest  1pc	M Storage Basket  1pc
W Power  2pcs	X Liner  1pc	A1 Footrest cushion  1pc	E1 Connection rods  1pc
Accessory Box  			
Parts Contained in the Accessory Box			
N Swyft-loks(N)  2pcs big	O Swyft-loks(O)  6pcs small	P Leg and Plastic Washer  8pcs	Q Plastic Plug  2pcs
R Screw M6*40mm  4pcs M6*40mm	S Screw M6*16mm  36pcs M6*16mm	T Screw M6*30mm  3pcs M6*30mm	U Allen Key  1pc
V Wheel  4pcs	D1 Swyft-loks(D1)  2pcs big	G1 Angle iron  1pc F1 Angle iron  1pc	H1 Metal Washer  4pcs





Box B Parts List

B Chaise  1pc	C Armrest(C)  1pc	F Chaise Cushion  1pc	G Backrest Pillow  2pcs
H Throw Pillow  1pc	I Iron Frame(I)  1pc	J Iron Frame(J)  1pc	B1 Front bezel  1pc

Box C Parts List

B Chaise  1pc	F Chaise Cushion  1pc	G Backrest Pillow  1pc	N Swyft-loks(N)  2pcs big
O Swyft-loks(O)  2pcs small	P Leg and Plastic Washer  4pcs	R Screw M6*40mm  2pcs M6*40mm	S Screw M6*16mm  8pcs M6*16mm
XY Iron Frame with Backrest Cover  1pc	H1 Metal Washer  2pcs		

Step1 Installaion of sofa legs with plastic washers

B		2	C		1	D		1	P		12
---	---	---	---	---	---	---	---	---	---	---	----

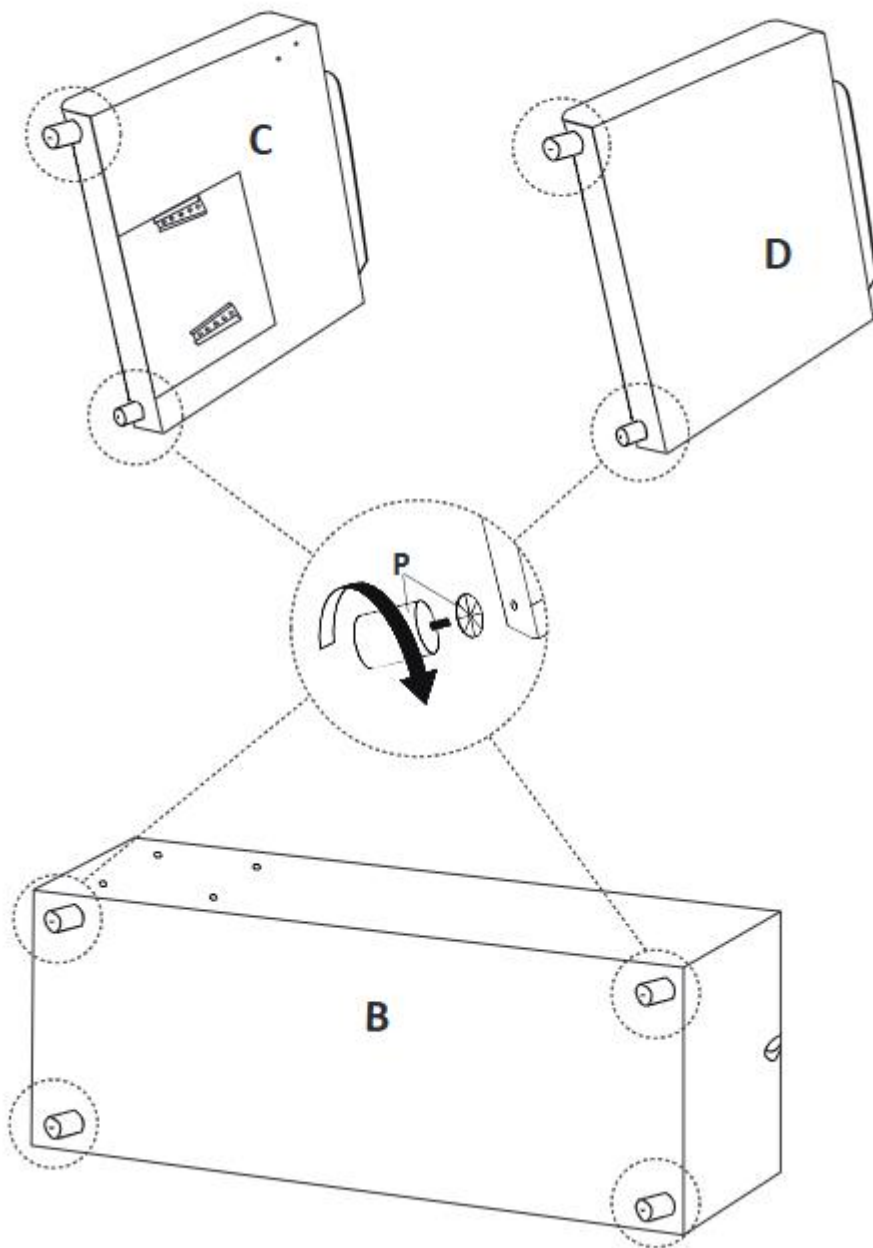

Step2 Fix the swyft-locks (D1) to the armrests with M6*16mm screws (S)

D1		2	S		4	U		1
----	---	---	---	---	---	---	---	---

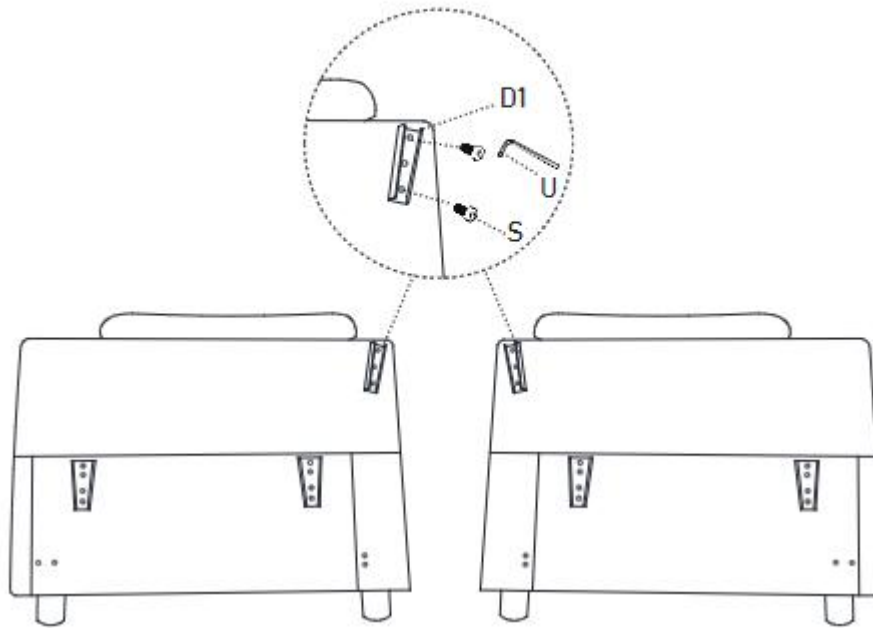

Step3 Fix the swyft-locks (O) to Sofa Base (A) with M6*16mm screws (S)

O		4	A		1	S		8	U		1
---	---	---	---	---	---	---	---	---	---	--	---



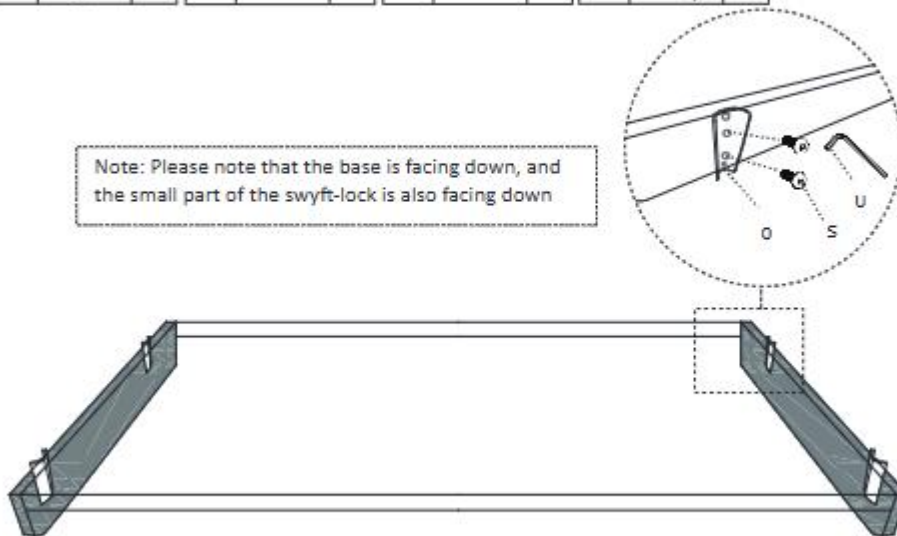

Note: Please note that the base is facing down, and the small part of the swyft-lock is also facing down



Step4

**Please decide the direction of the sofa
chaise before your start installtion**

Check the instructions carefully and install the Swyft-loks in the direction you want the recliner to go, which determines whether the chaise is on the left or the right.

L shape B  1 N  2 O  2 S  8 U  1

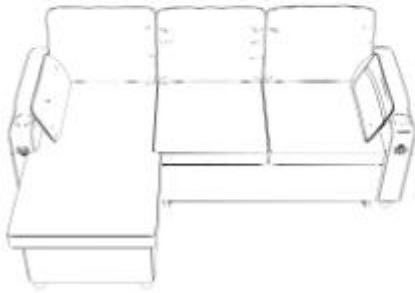

L shaped sofa (Right Facing)

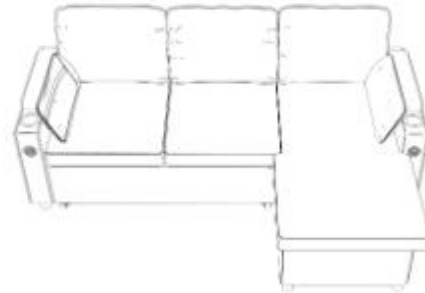

L shaped sofa (left Facing)

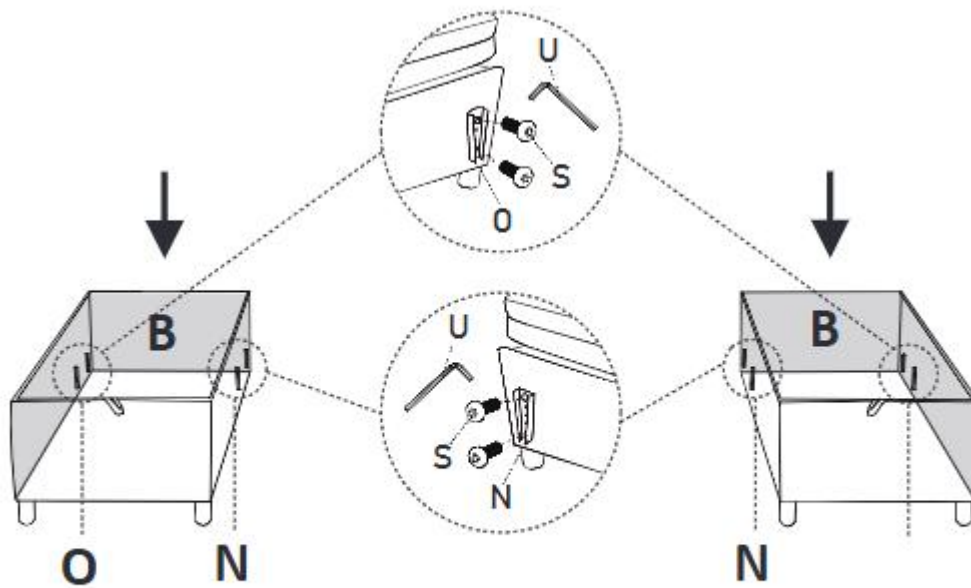





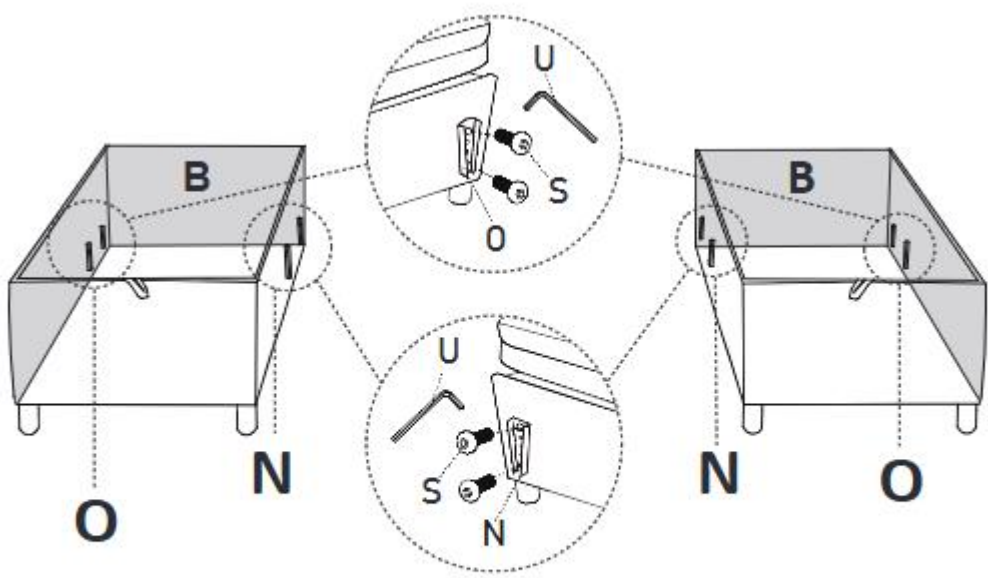
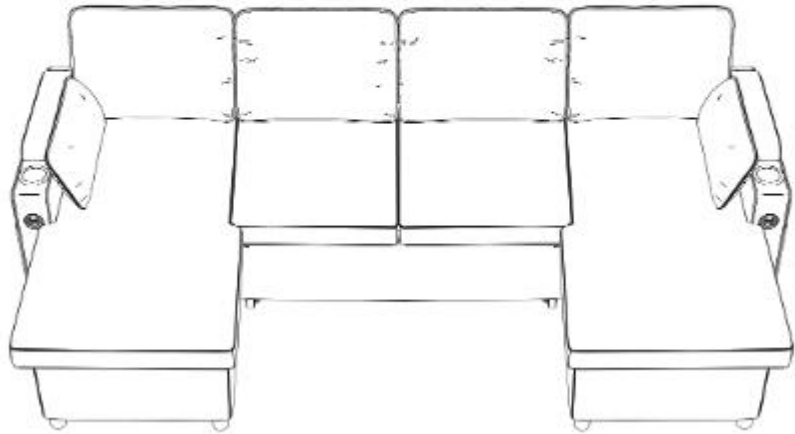



If you buy a U shape sofa, Note that the Swyft -loks on the two chaises must be installed opposite each other as shown.

U shape B 2 N 4 O 4 S 16 U 1



Step5 Connect sofa base & armrest

L shape	E1		1	B		1	C		1	D		1
	F1		1	G1		1	S		8	U		1

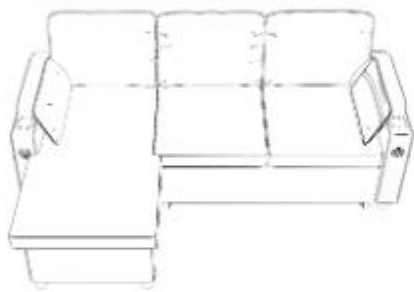

L shaped sofa (Left Facing)

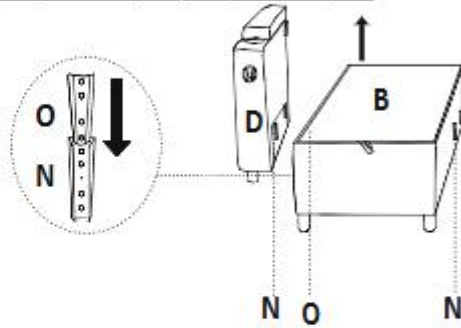

Connect armrest (D) to chaise (B) first

Note: The Velcro side of Rod is on the back of the couch
Iron plates with screw holes are on the upper side

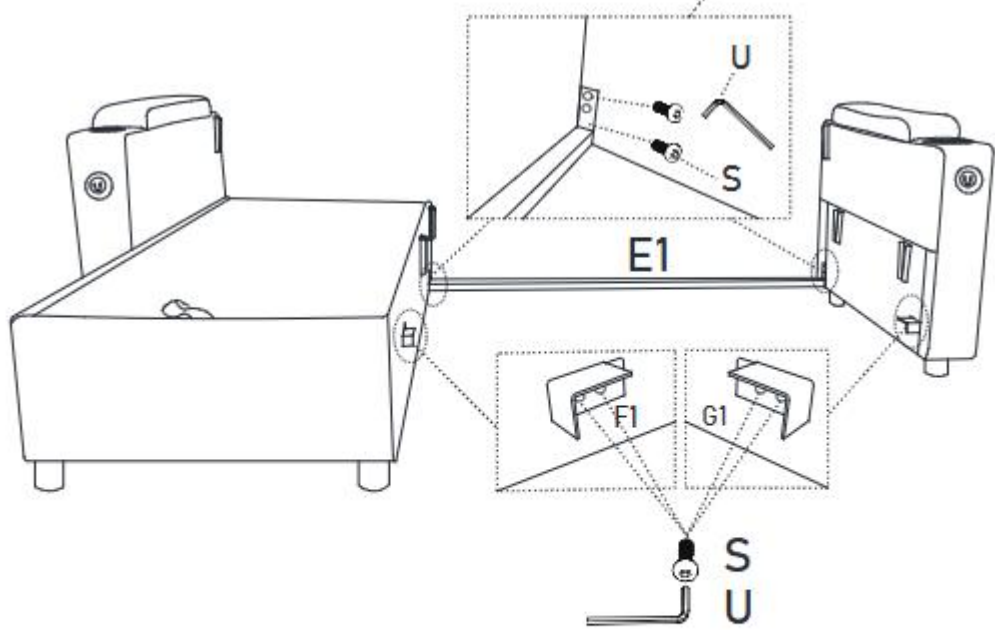

Fix the connecting rod (E1) with M6*16mm screws (S)
Fix the angle iron on chaise (F1) Fix the angle iron (F1) on armrest (C)

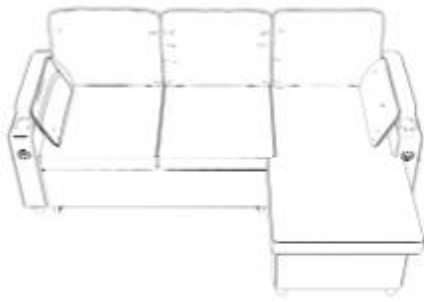

L shaped sofa (Right Facing)

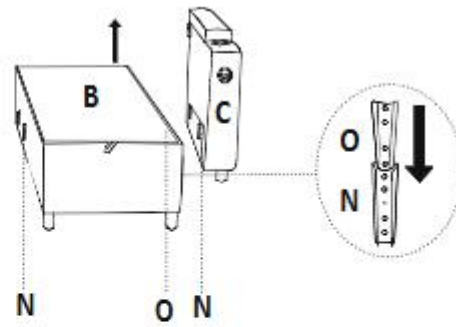





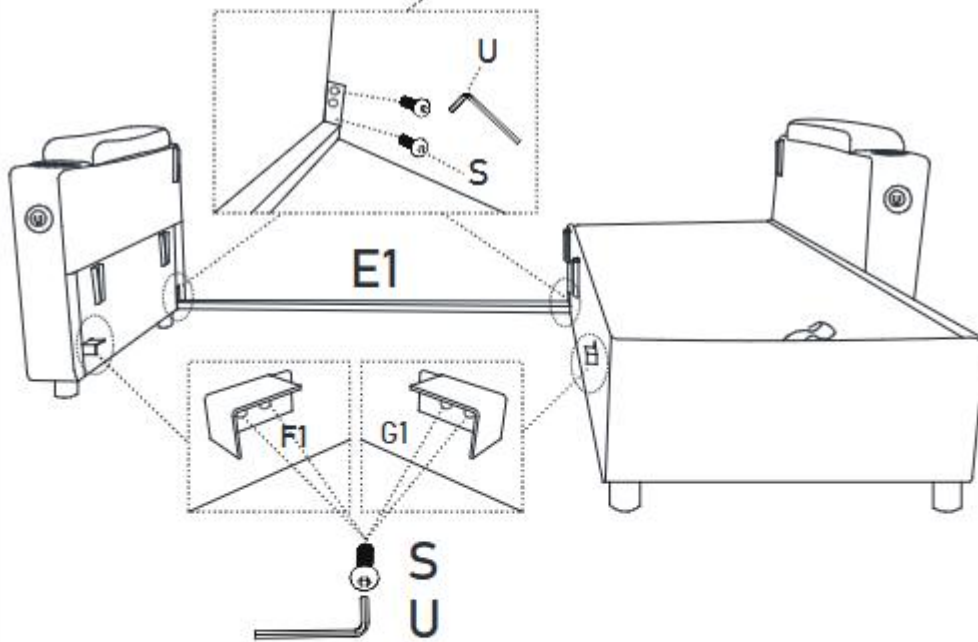



Connect armrest (C) to chaise (B) first

Note: The Velcro side of Rod is on the back of the couch
Iron plates with screw holes are on the upper side



Fix the connecting rod (E1) with M6*16mm screws(S)
Fixed angle iron on chaise (G1) Fixed angle iron (F1) on armrest (D)

If you buy a U shape sofa, Note that the Swyft-loks on the two chaises must be installed opposite each other as shown.

U shape	E1		1	F1		1	B		2	G1		1
	C		1	S		8	D		1	U		1

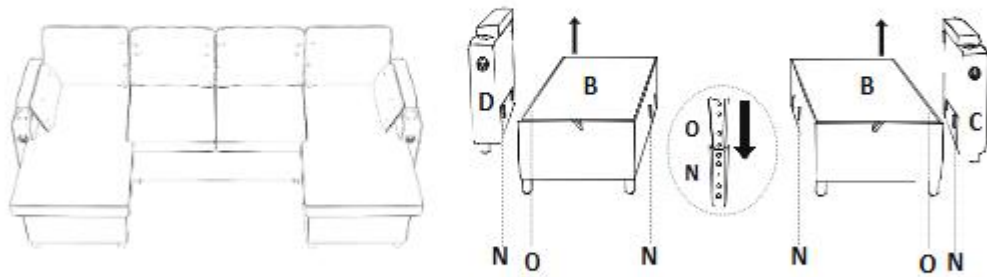

U shaped sofa

Attach the left and right armrests to each Chaise

Note: The Velcro side of Rod is on the back of the couch
Iron plates with screw holes are on the upper side

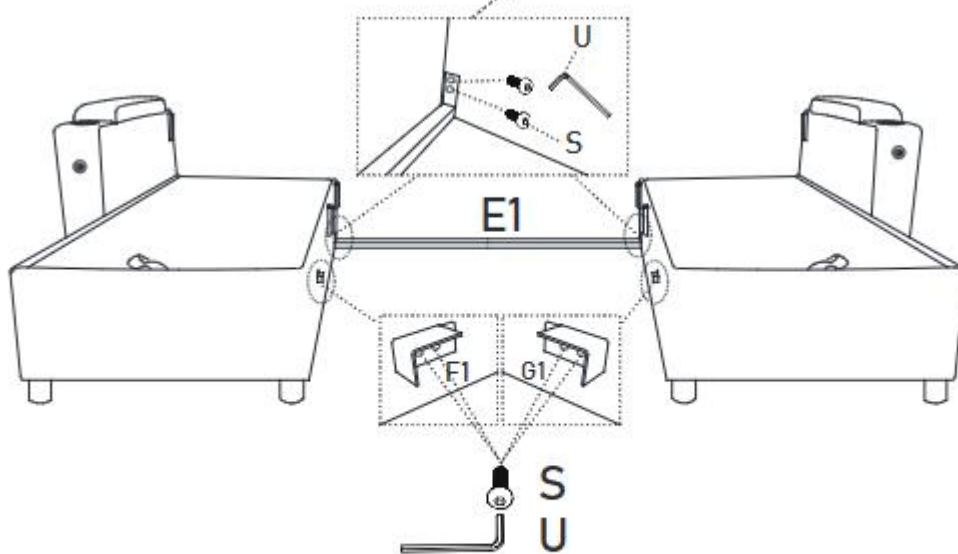

Fix the connecting rod (E1) with M6*16mm screws (S)
Fix the angle iron (F1, G1) to each chaise

Step6 Install the sofa base



Please kindly note that the small round metal insert part O is inserted into the large square metal insert part N.

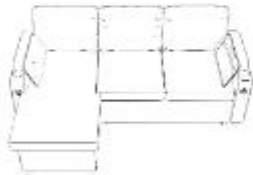
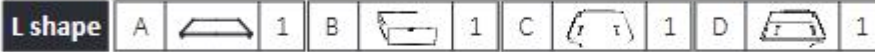

L shaped sofa (LeftFacing)

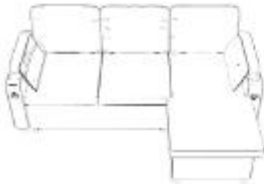
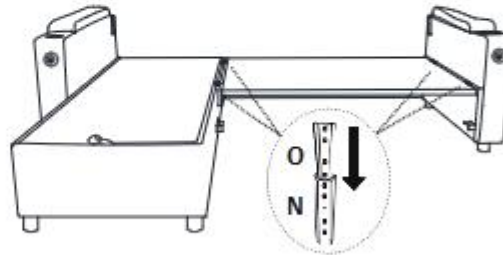

L shaped sofa (Right Facing)

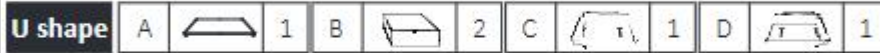
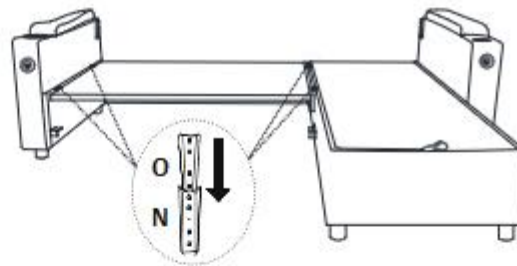



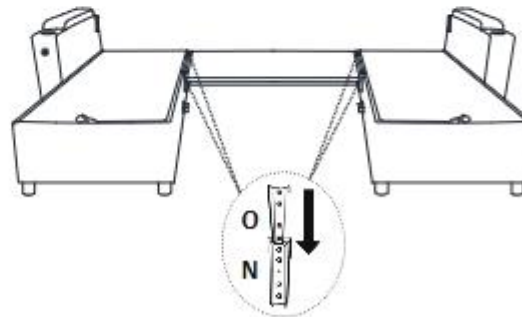
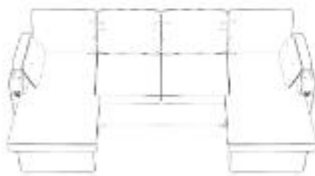

U shaped sofa



Step7 Fasten part I & J fittings with the screws R and washers H1.

L Shaped Sofa & U Shaped Sofa

L shape	I	ε	⊔	1	J	⊔	1	R		4	H1		4	U		1
	K															

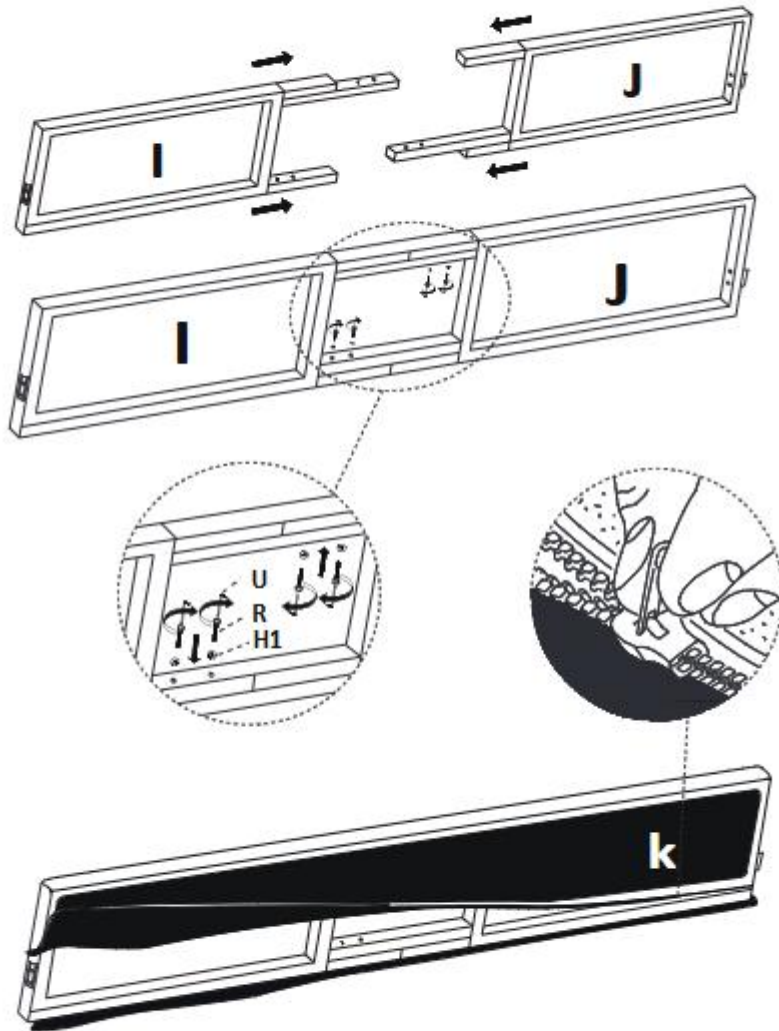

Fasten part I & J fittings with the screws R.
 Please do NOT tighten any of the 4 screws until they are all aligned.
 Then place cover K on frames I and J.

U Shaped Sofa ONLY

U shape R 2 H1 2 U 1 XY 1



Remove Swyft-loks on the left side of part I.

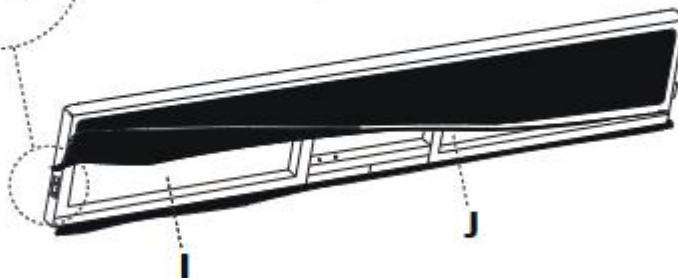

Open the zipper of XY

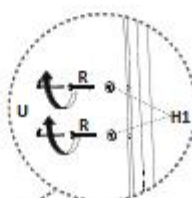

Fasten part XY and part I, fittings with the screws R and washers H1, then zipper part XY up.

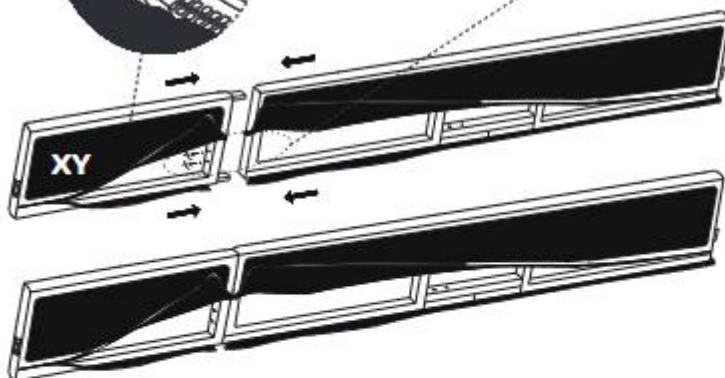

Pay attention to the direction of insertion of the screws, it is necessary to insert part I fittings from part XY.

Step8 Insert the backrest into the sofa

L shape

U shape

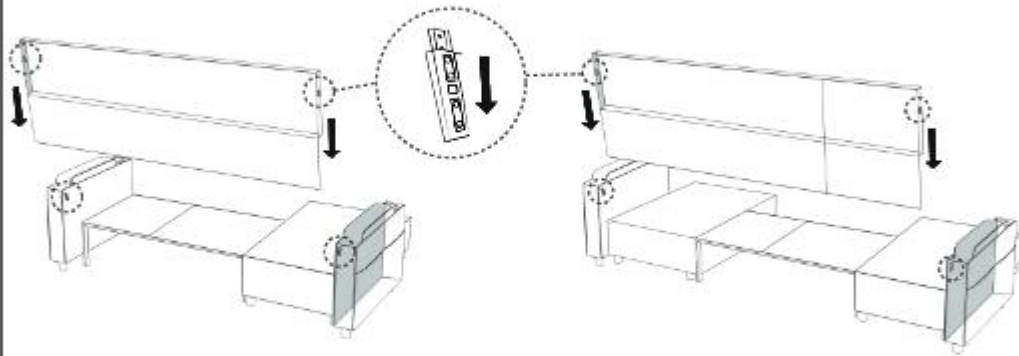

When inserting the iron frame I and j into the sofa, it is oriented so that where the metal clasps are located on both sides, the distance below is shorter than the distance above.

Step9 Insert Plastic PART Q into backrest Side

L shape



U shape

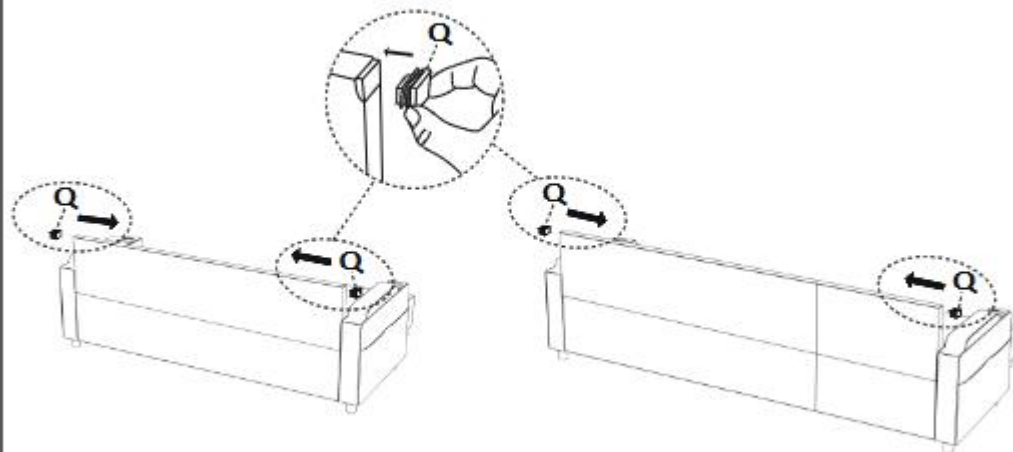

Step10 Fasten the 4 wheels (V) to the iron frame with screws M6*16mm (S)

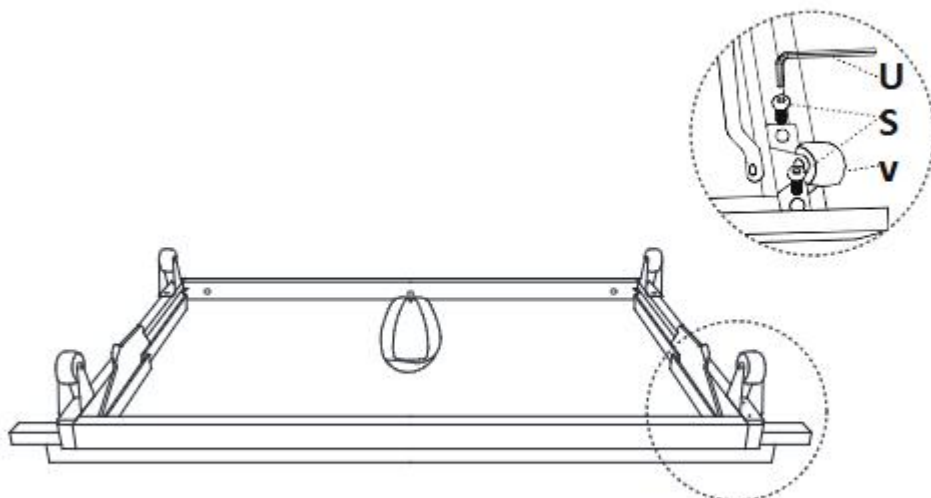

Step11 Wrapping the Velcro around the iron frame to secure the storage basket (M)

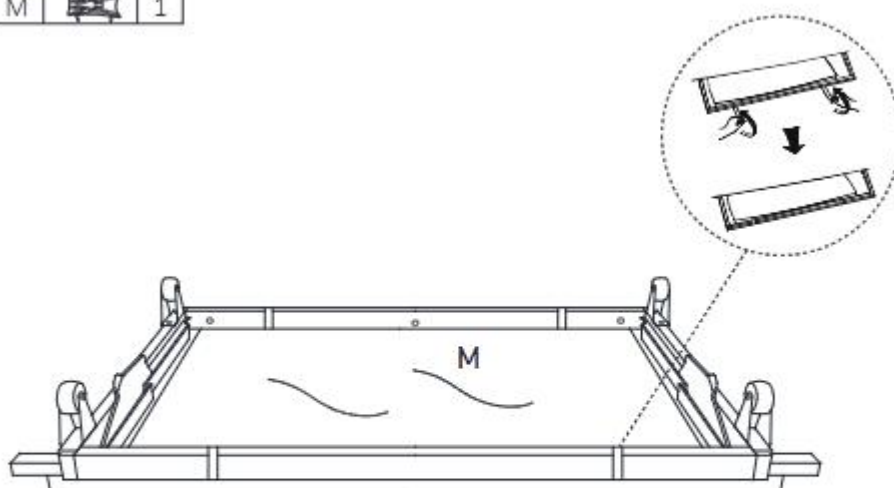

Step12 Fix the panel (B1) on the iron frame with M6*30mm screws (T)

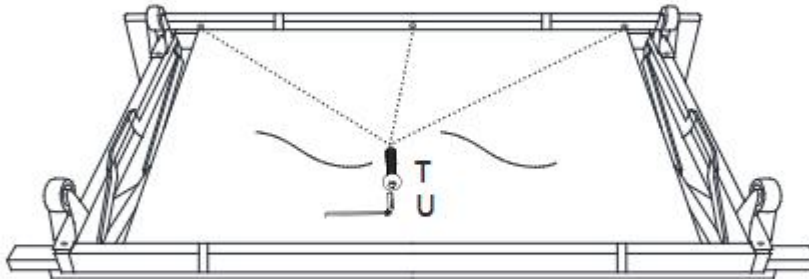

Step13 Place Liner (X) in the storage area of footrest.

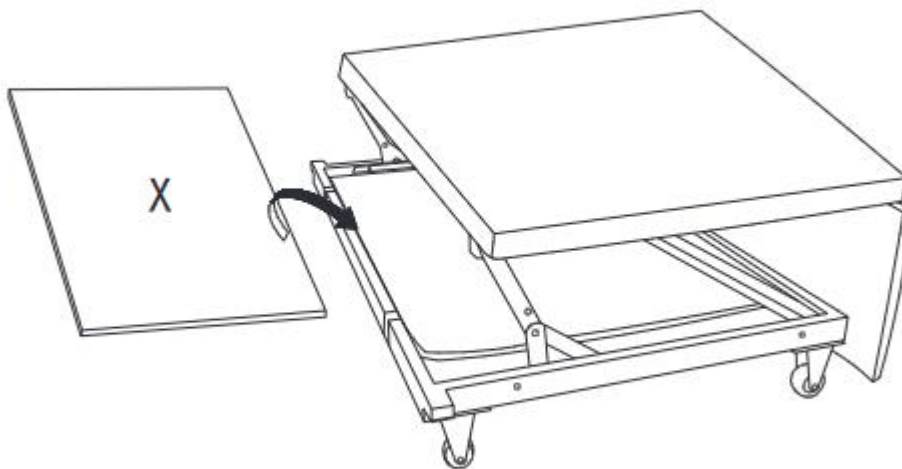

Step14 Place the cushion (A1) on the Footrest (L)

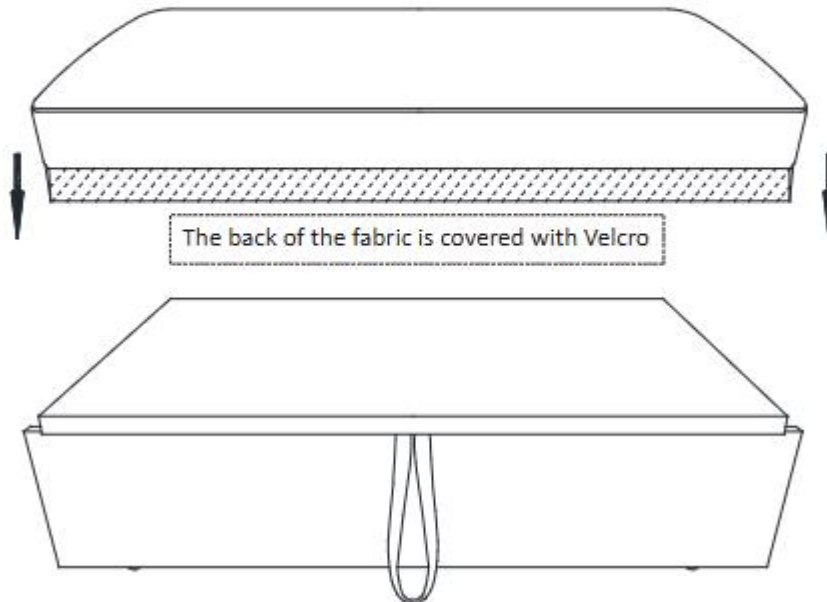
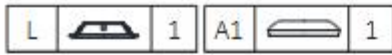

Step15 Attach the fabric to the underside of the backing board

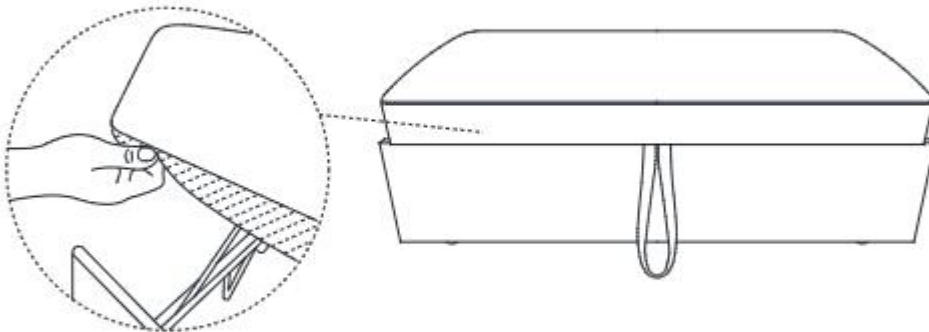

Note: Please completely cover the footrest support board with fabric and place Velcro on the bottom of the support board

Step16 Please lift up the footrest L so that the wheels are above the iron frame before sliding into the sofa.

L shape

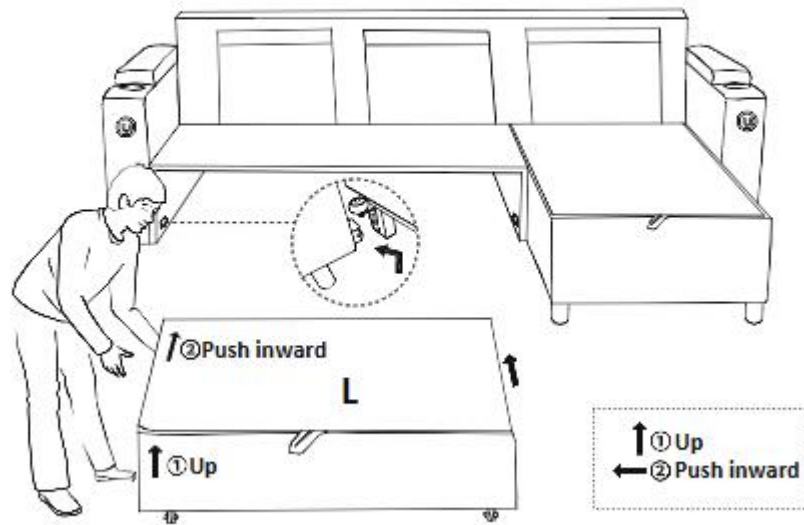



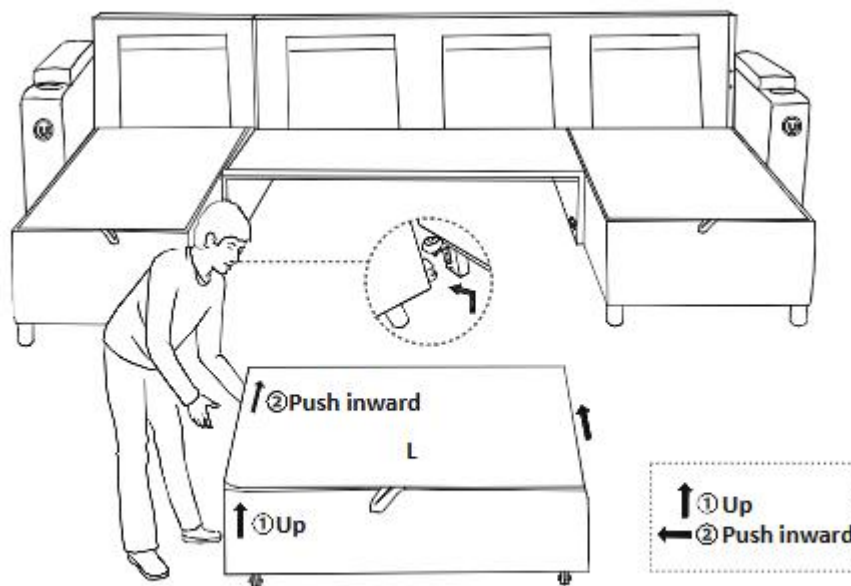

U shape

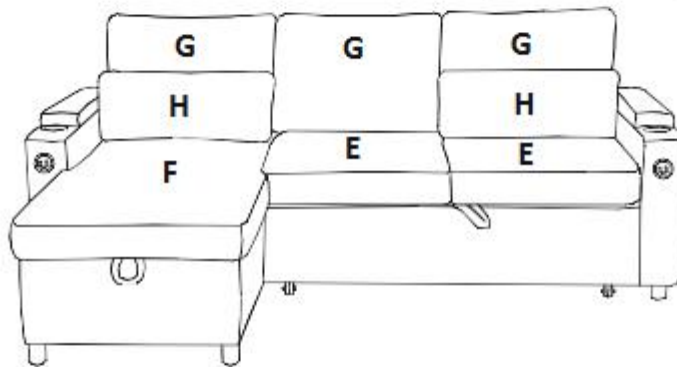
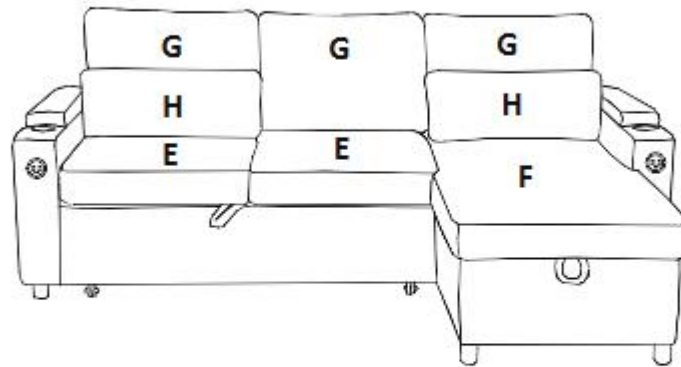

Step17 Put cushions and pillows on the sofa

L shape E  2 F  1 G  3 H  2



U shape E  2 F  2 G  4 H  2

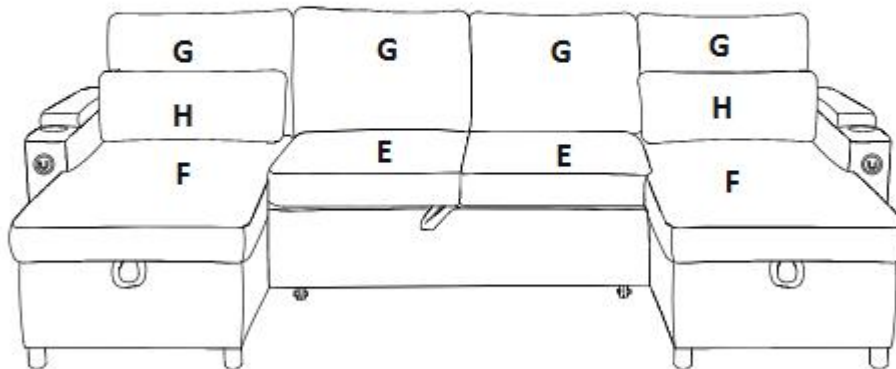

How To Replace USB?

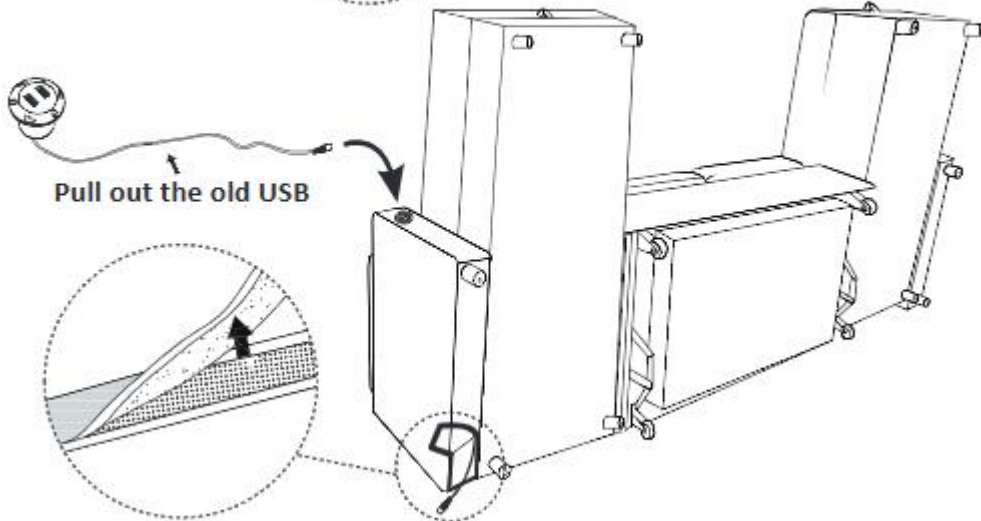
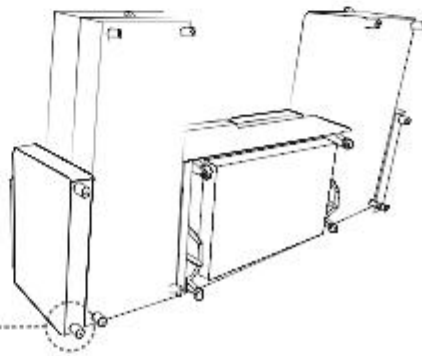
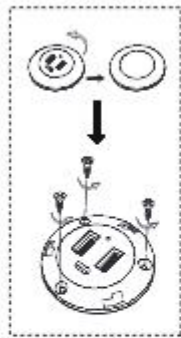

Pull in the new USB and tighten the screws.

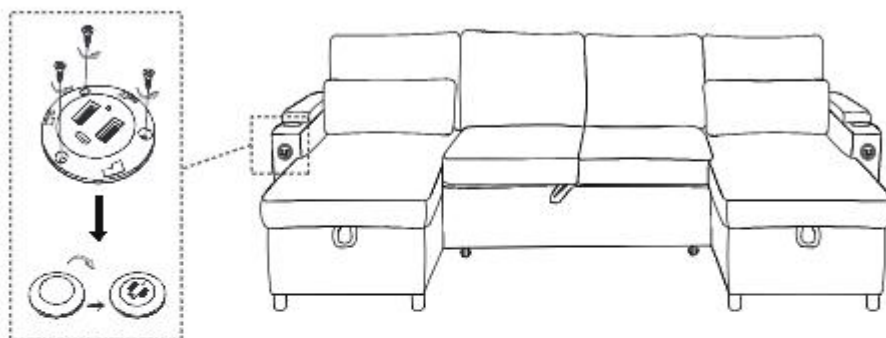

Find the USB cable and pull it out.

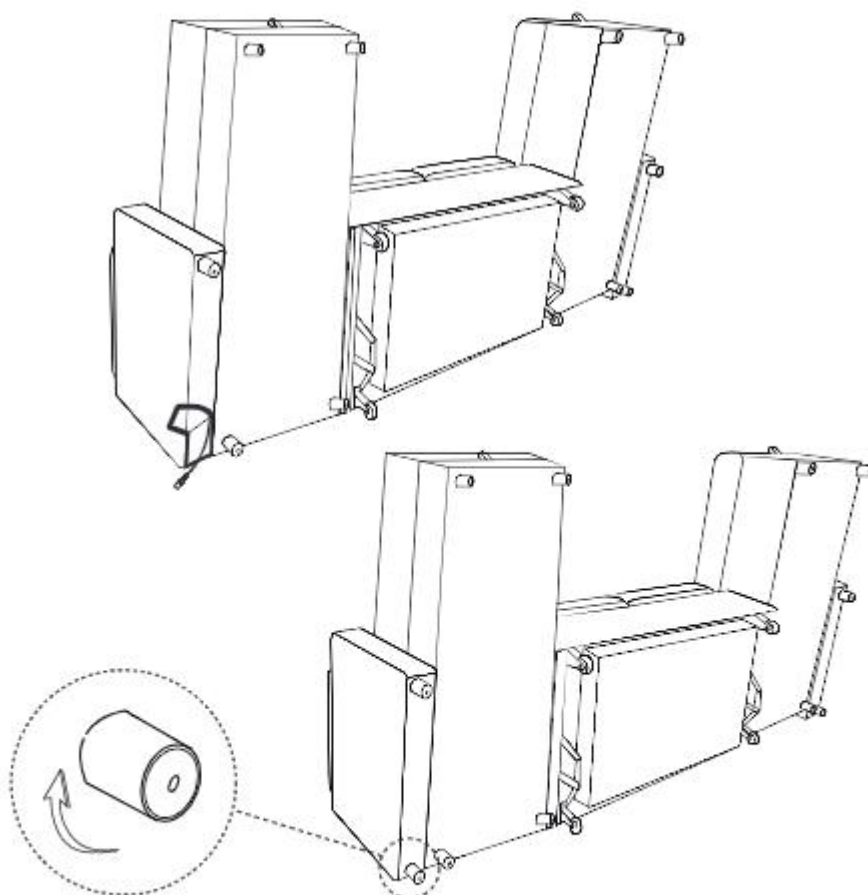

Your cushions come vacuum packed and sealed for shipping. To restore the cushion's original shape, follow the steps below.

After packing up, place them somewhere dry and ventilated. After about 72 hours it can be restored to its best-use condition.

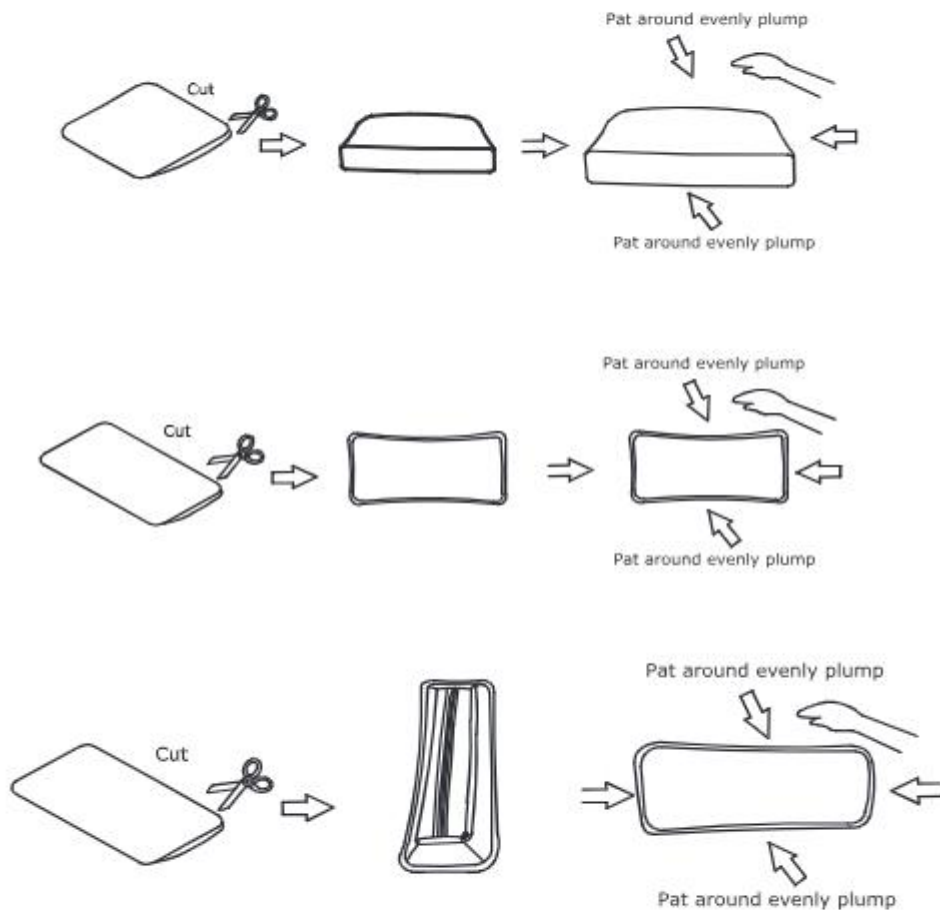

Uneven Fabric is a normal phenomenon that the first time you open it, the fabric is uneven. Because the fabric is easy to crease after long time transport in vacuum compression. You can use an iron to smooth it out, have a try!