

ASSEMBLY INSTRUCTION

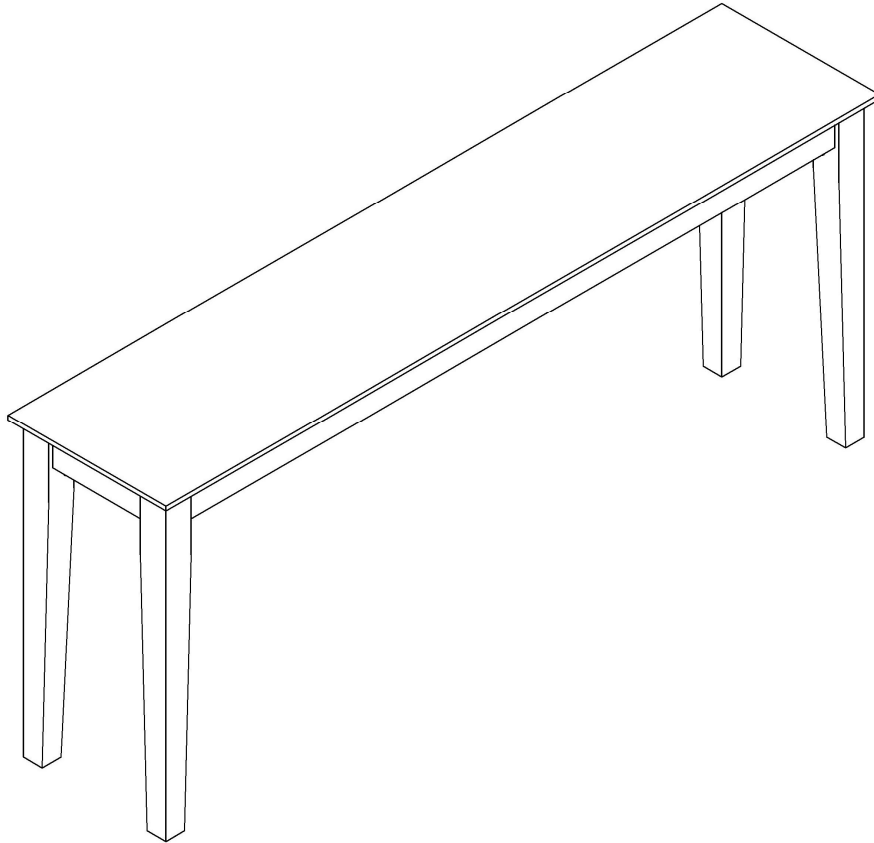

Description 72 IN SOFA TABLE

BEFORE ASSEMBLY

IMPORTANT NOTE:

- Place all wooden parts on a clean and smooth surface such as a rug or carpet to avoid the parts from being scratched.
- Remove all wrapping material, including staples & packing straps before you start to assemble.
- DO NOT tighten all screws, bolts until all completely assembled.
- Keep all hardware parts out of reach of children.

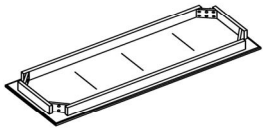
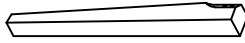

PART LIST

When unpacking, please carefully not to discard any parts with the packaging. Before continuing, please make sure you have all of the following parts:

NO	Description	Qty	Sketch	NO	Description	Qty	Sketch
A	Top Table Frame	1		B	The Leg	4	

HARDWARE LIST

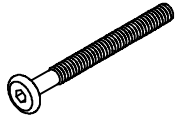
When unpacking, please carefully not to discard any parts with the packaging. Before continuing, please make sure you have all of the following hardware:

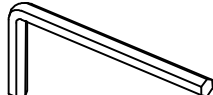
NO	Description	Qty	Sketch	NO	Description	Qty	Sketch
1	Bolt (M8x60mm)	8		3	Lock Washer (Φ8.5X13mm)	8	
2	Flat Washer (Φ8.5X19mm)	8		4	Allen Key (4 x 80mm)	1	

STEP 1

Attach Legs (B) to Top (A) with Bolts (1), and washers (2) and (3) as shown below. Tighten with Allen Key (4).

