

# ASSEMBLY INSTRUCTION

## Step 3

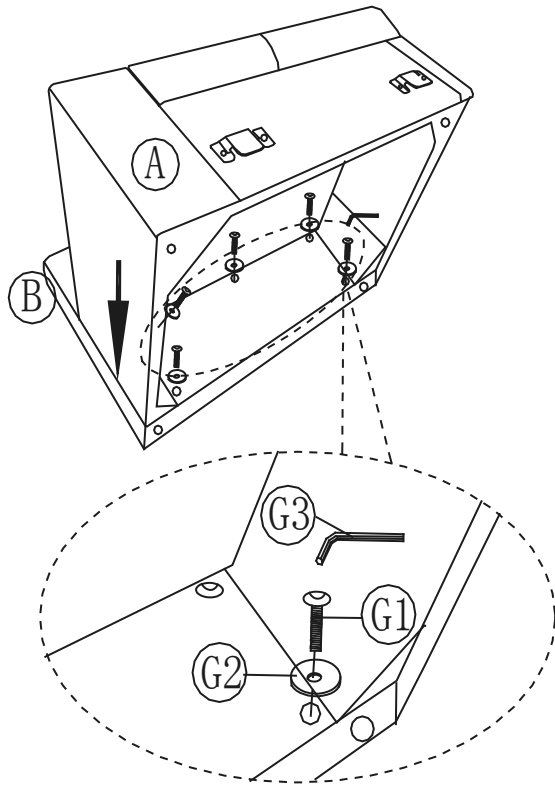

## Step 4

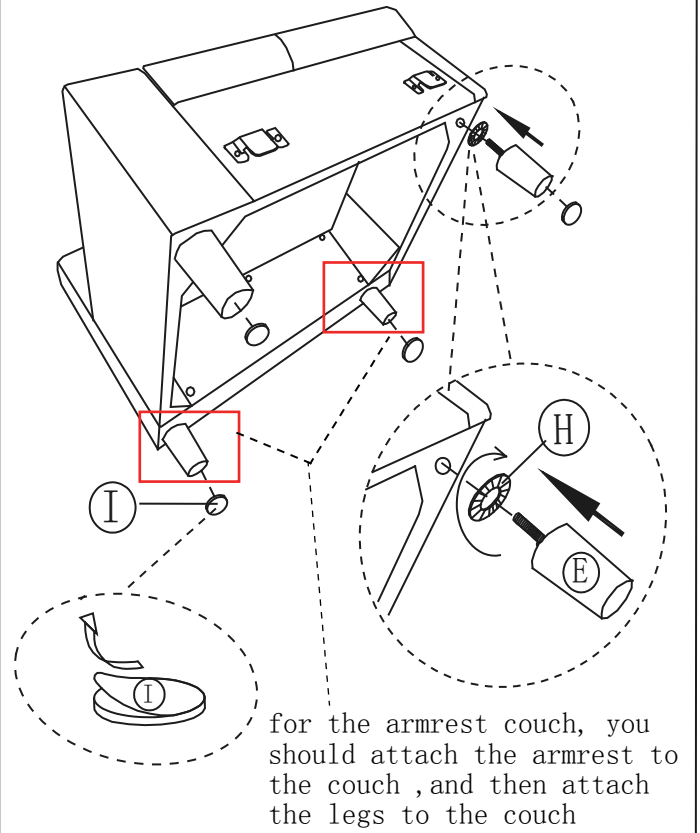

## Step 5

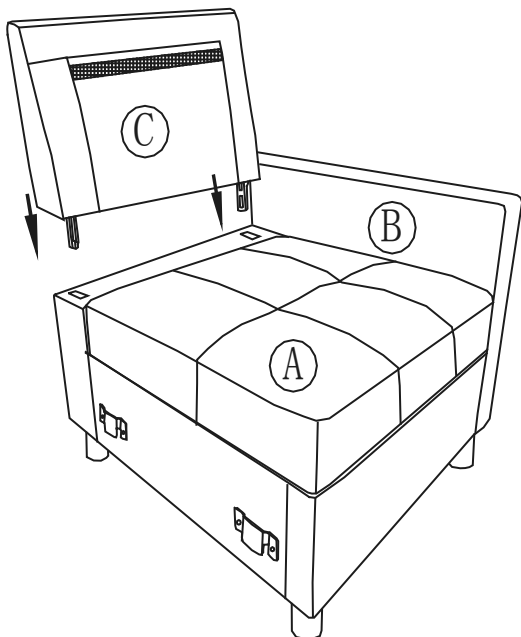

## Step 6

