

ASSEMBLY INSTRUCTON

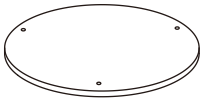

A*1Pc

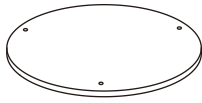

B*1Pc

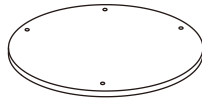

C*1Pc



D*6Pcs



E*4Pcs



F*10Pcs

1

Never Tight Top Screw By Hand!

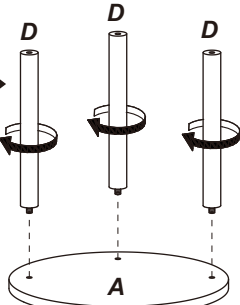
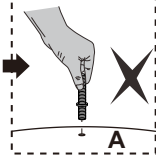

2

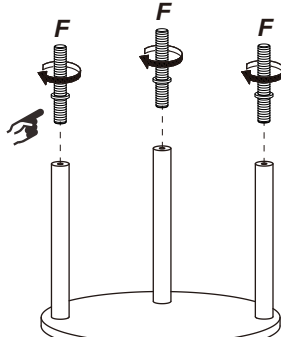

3

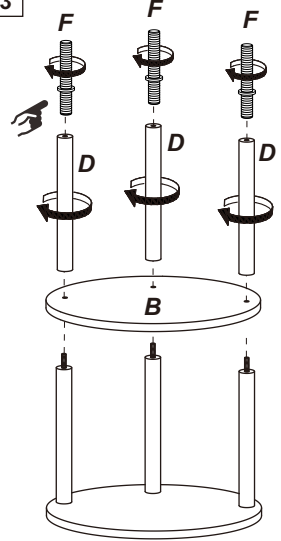

4

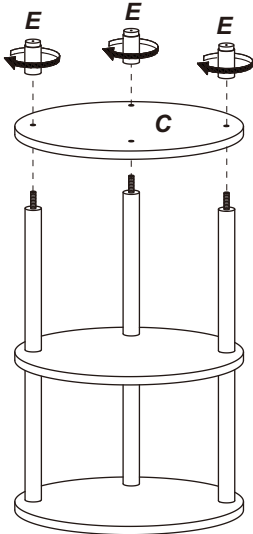

5

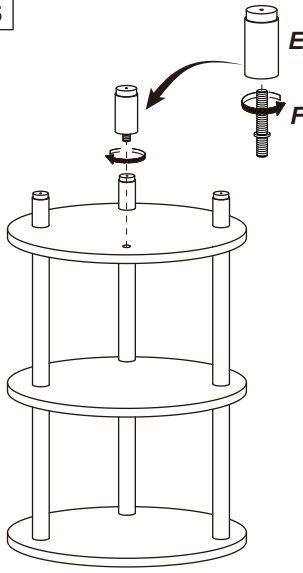

6

