

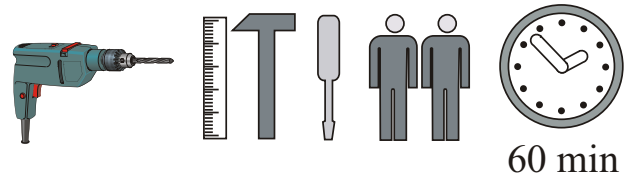

NO	Dim.		Col.-No	Qty
1	1668	274	1	1
2	1668	274	1	1
3	400	274	1	2
4	364	234	1	3
105	1680	378	1	1
6G	394	410	1	1
6D	394	410	1	1
7	925	362	1	1

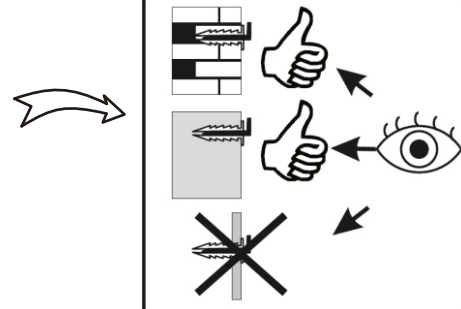
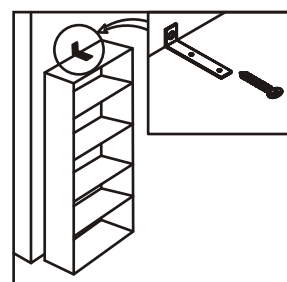
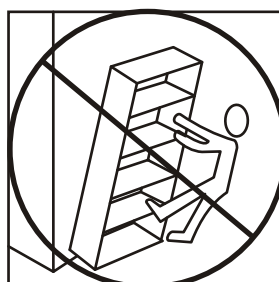
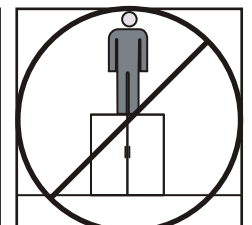
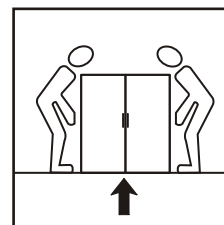
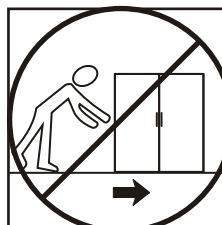
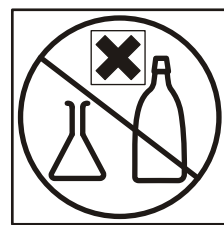
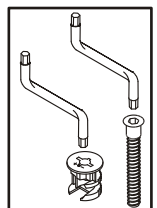
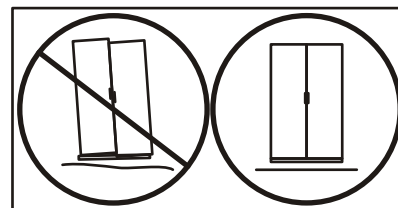
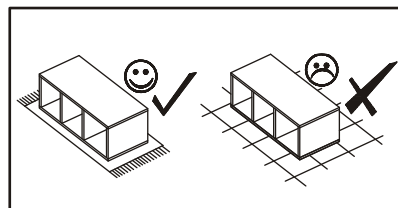
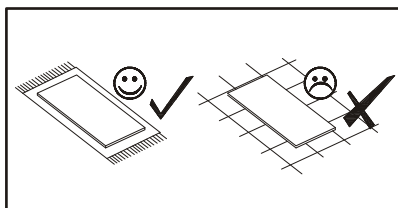
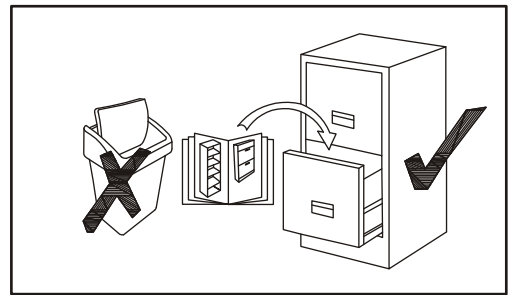
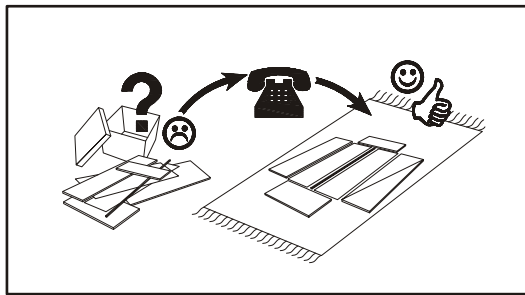
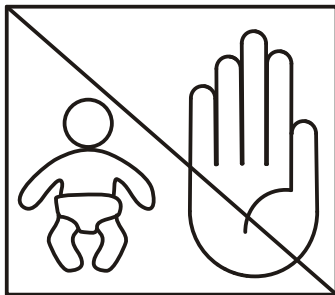
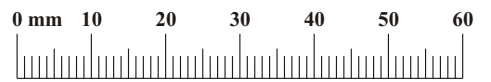

60 min

A1 x8 ø8x36	B4 x8	B5 x8 ø15x12	G5 x8	ZR1 x2	D6 x4 USØ3,5x30
E2 x4 H=0	E1 x4 Ø26 H=0	D10 x10 USØ3,5x13	AM x1	G20 x12	Z2 x8 Ø5
P2 x6	UP13 x6 UPØ3x16	S1 x12	KR2 x2	G2 x1	

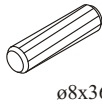

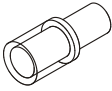

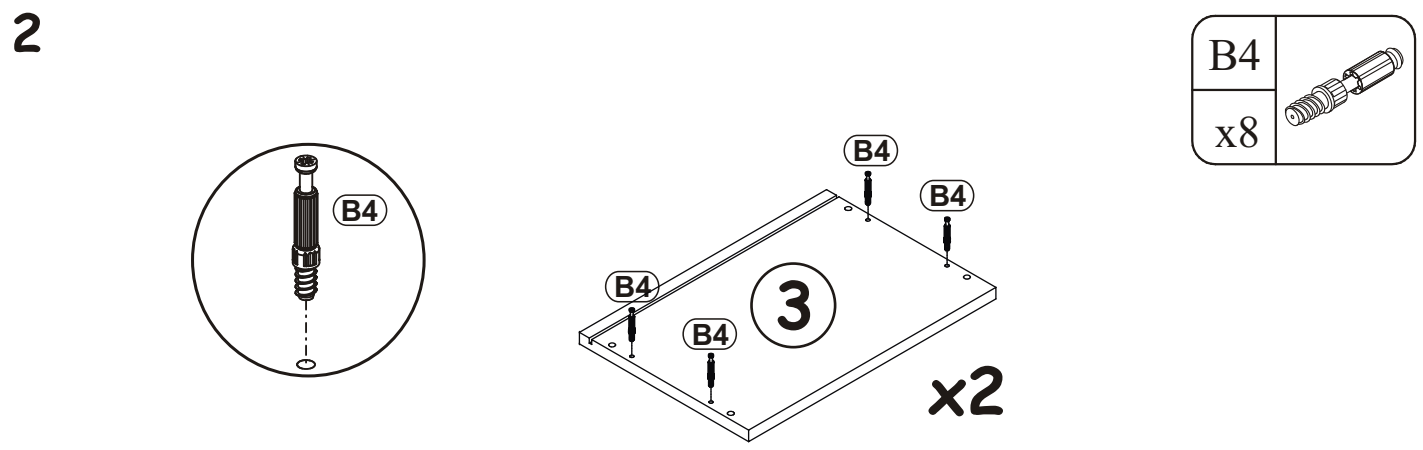
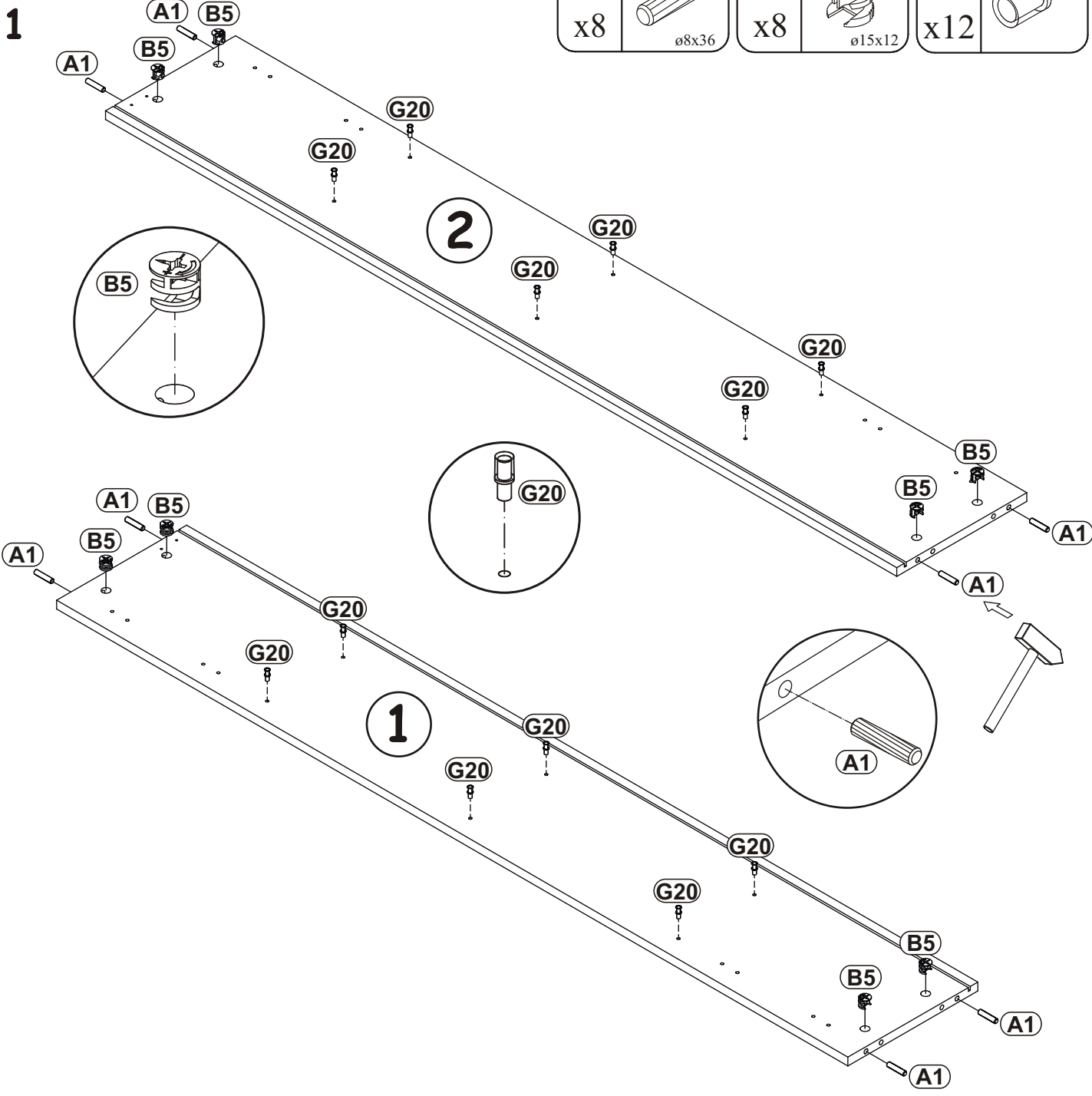
A1		B5		G20	
x8	ø8x36	x8	ø15x12	x12	

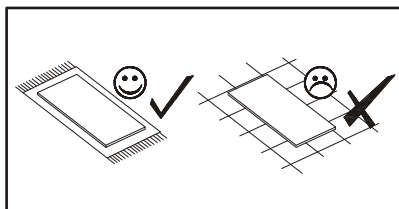

3

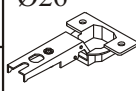
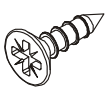

E1	Ø26	D10	
x4	 H=0	x8	 USØ3,5x13
P2		UP13	
x6		x6	 UPØ3x16

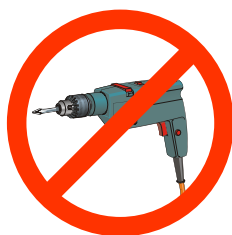
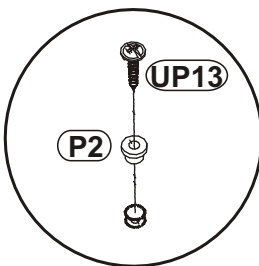
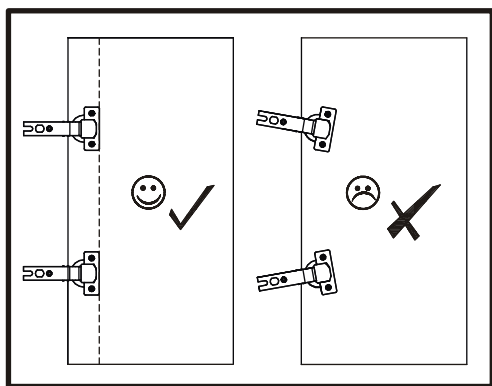
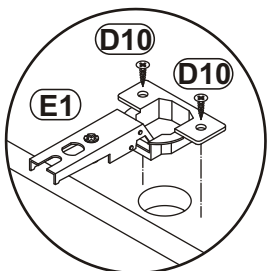

4

G5	
x4	

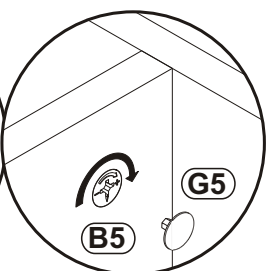
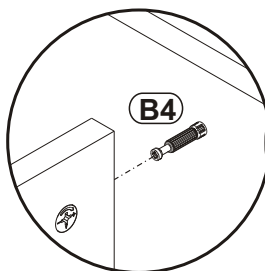
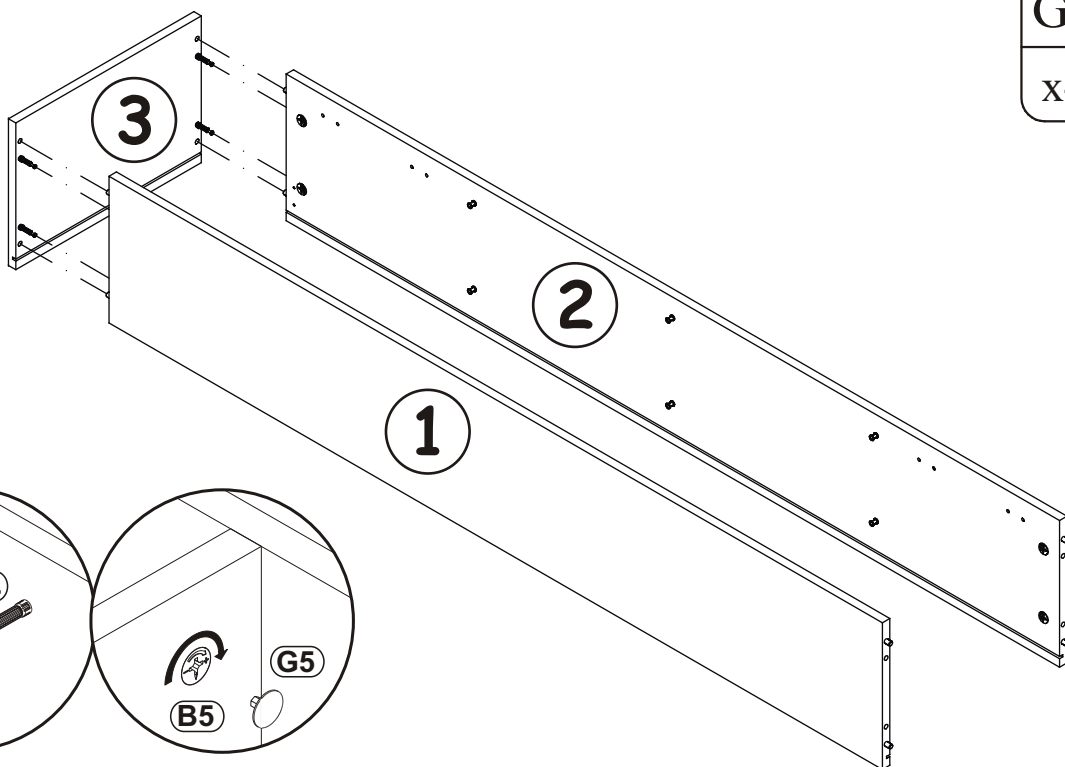

7

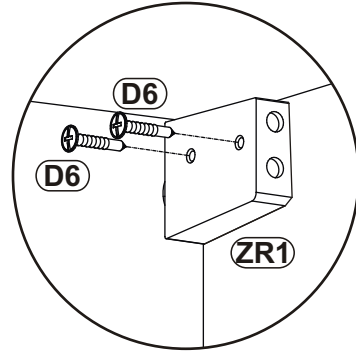
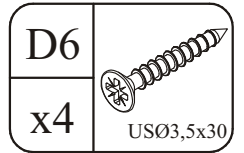
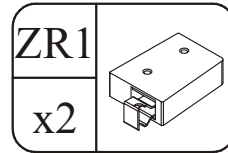
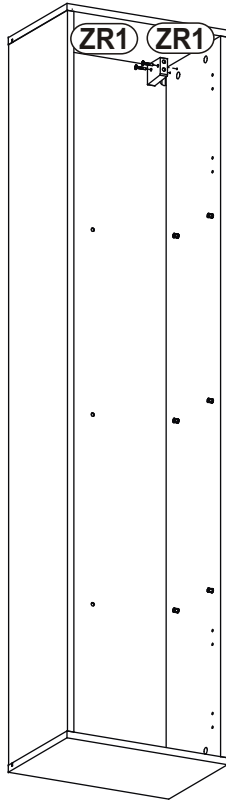
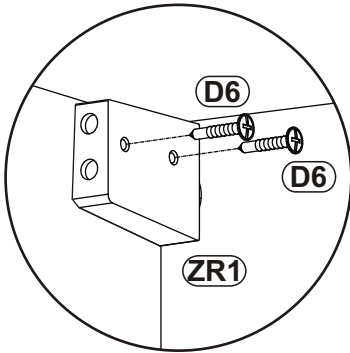

8

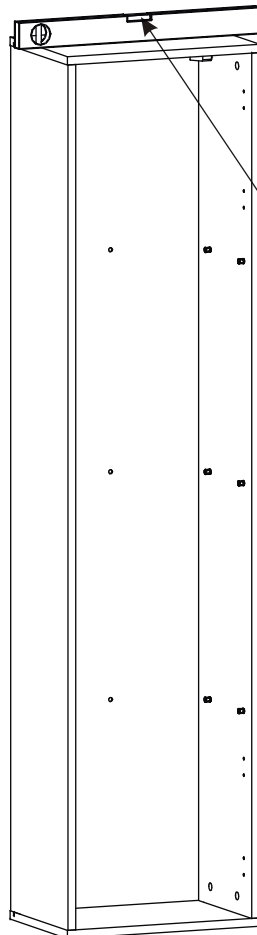
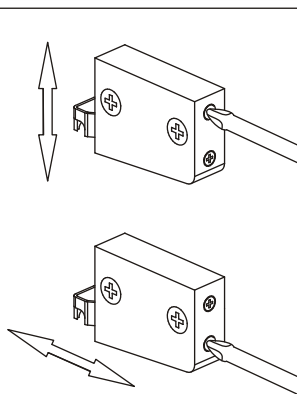
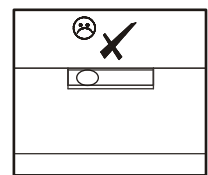
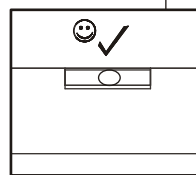
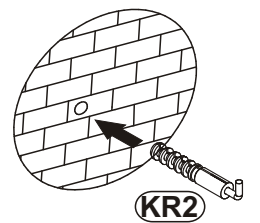
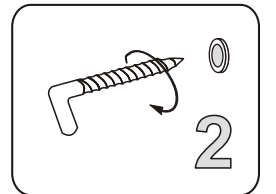
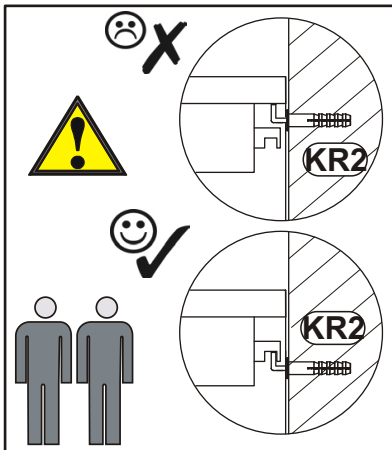
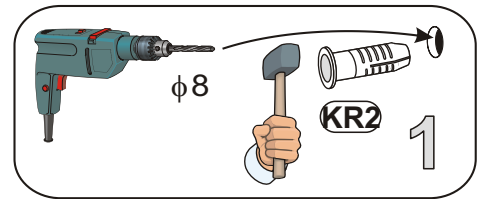
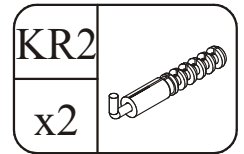
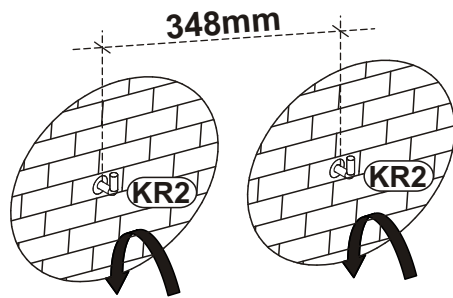
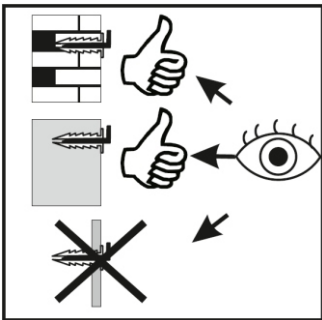

9-10

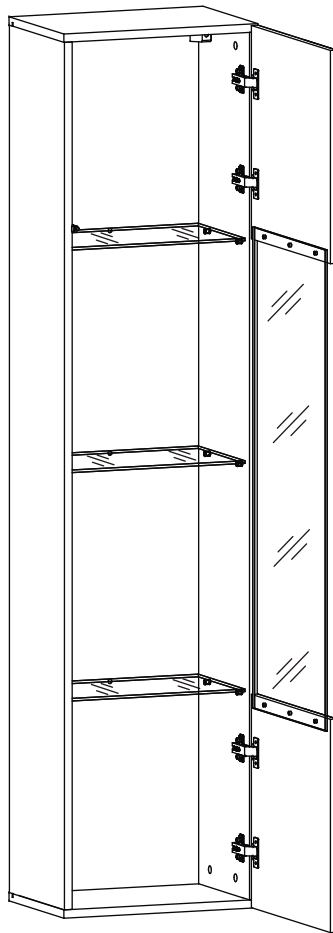

11-12

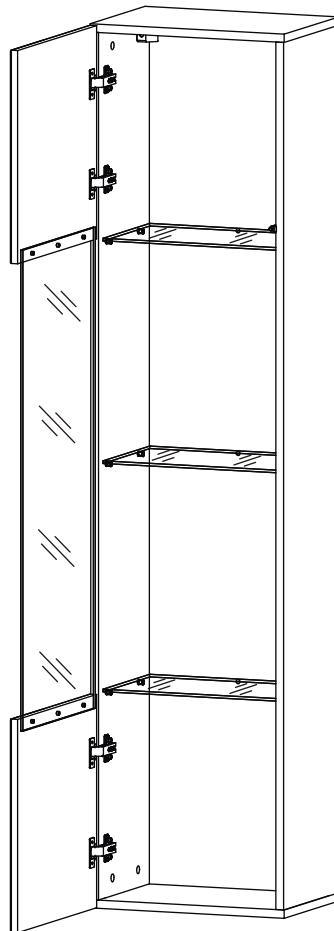

9

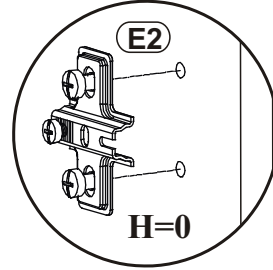
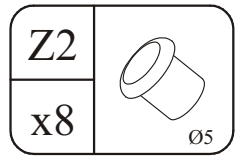
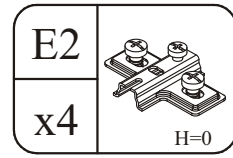
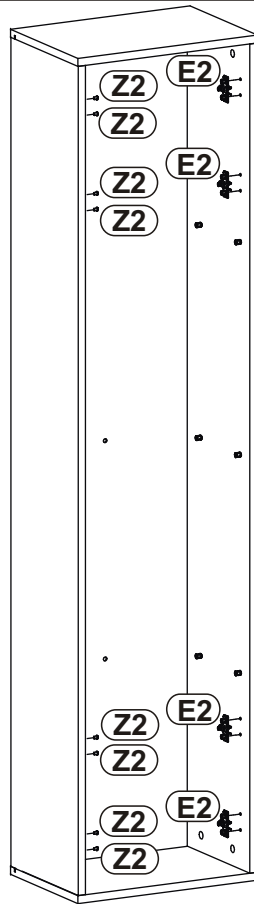
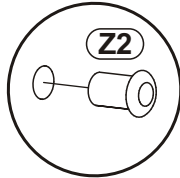
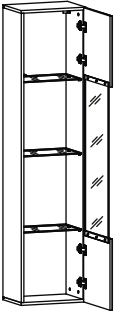

10

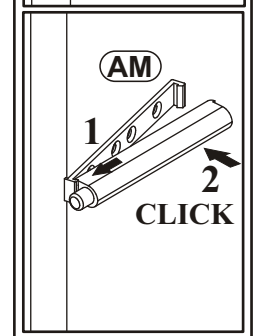
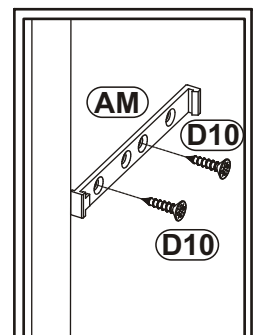
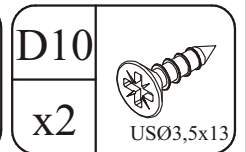
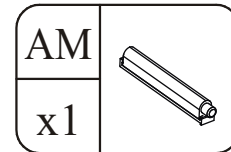
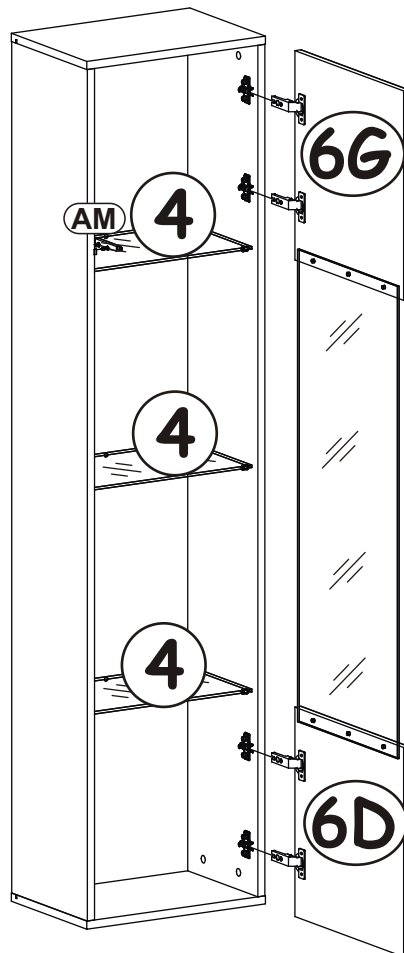
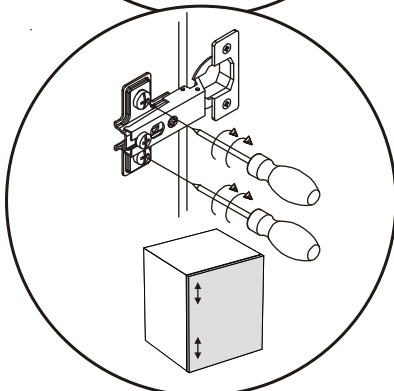
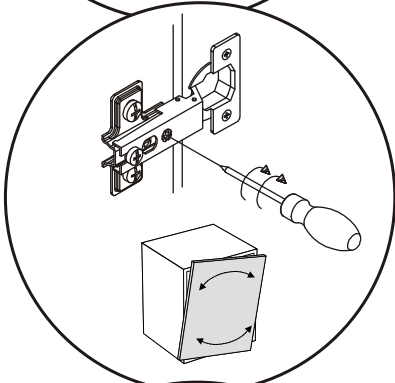
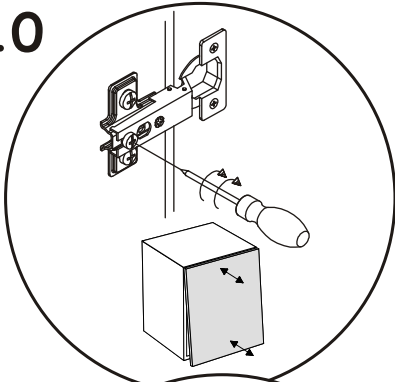

11

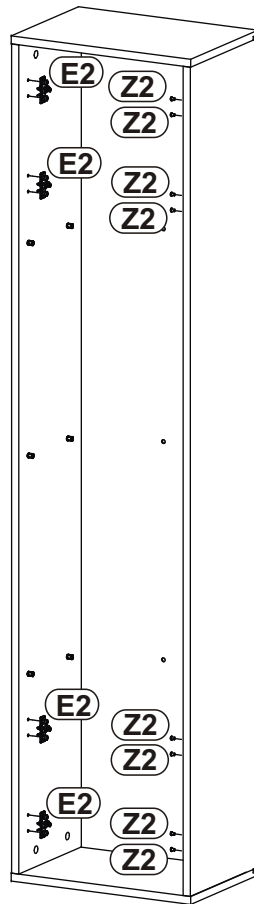
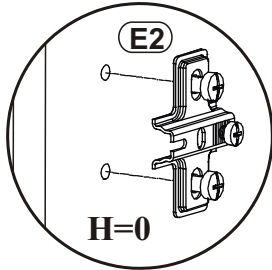
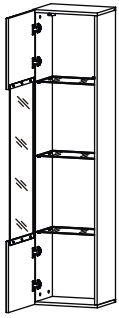

E2		Z2	
x4	H=0	x8	Ø5

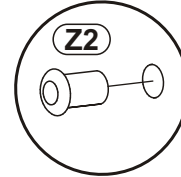

12

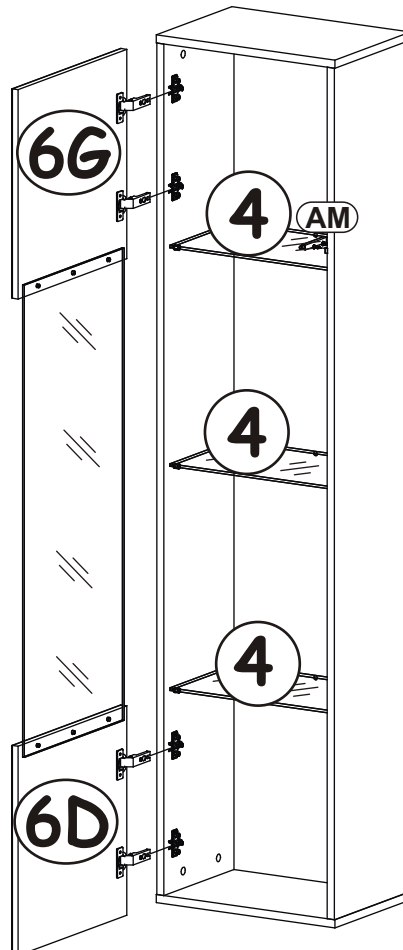
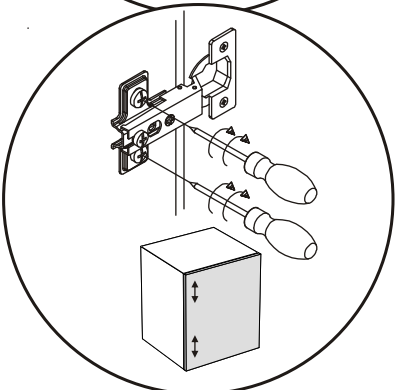
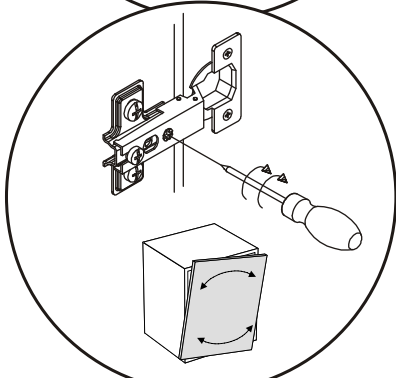
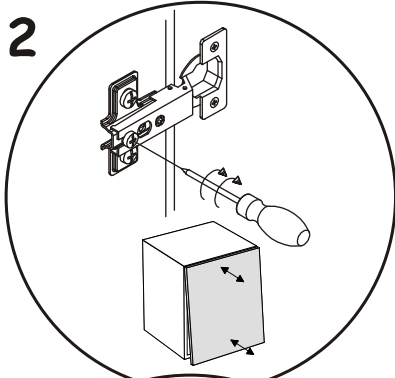

AM		D10	
x1		x2	USØ3,5x13

