

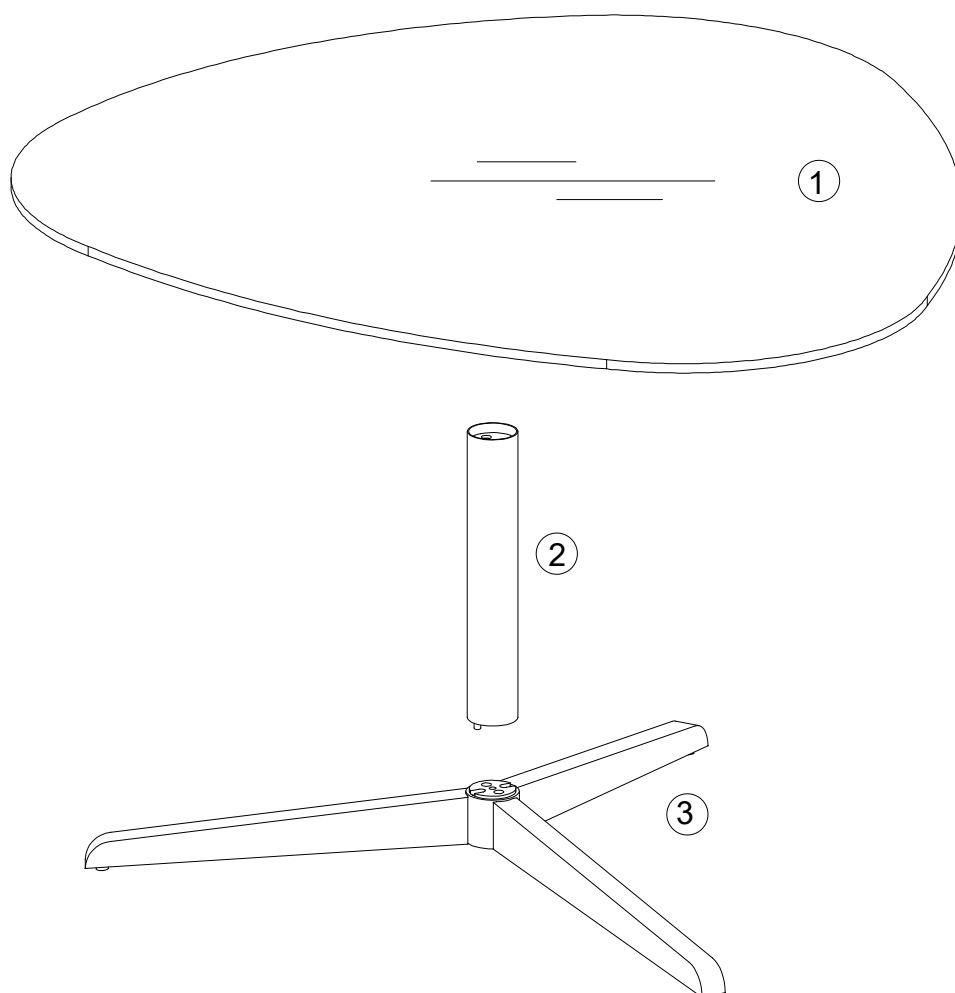







			✓
①	1	1030x950x10/ 1000x950x12	
②	2	∅50x314	
③	3	723x661x87	

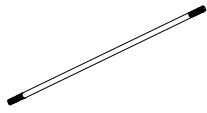

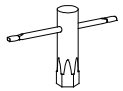

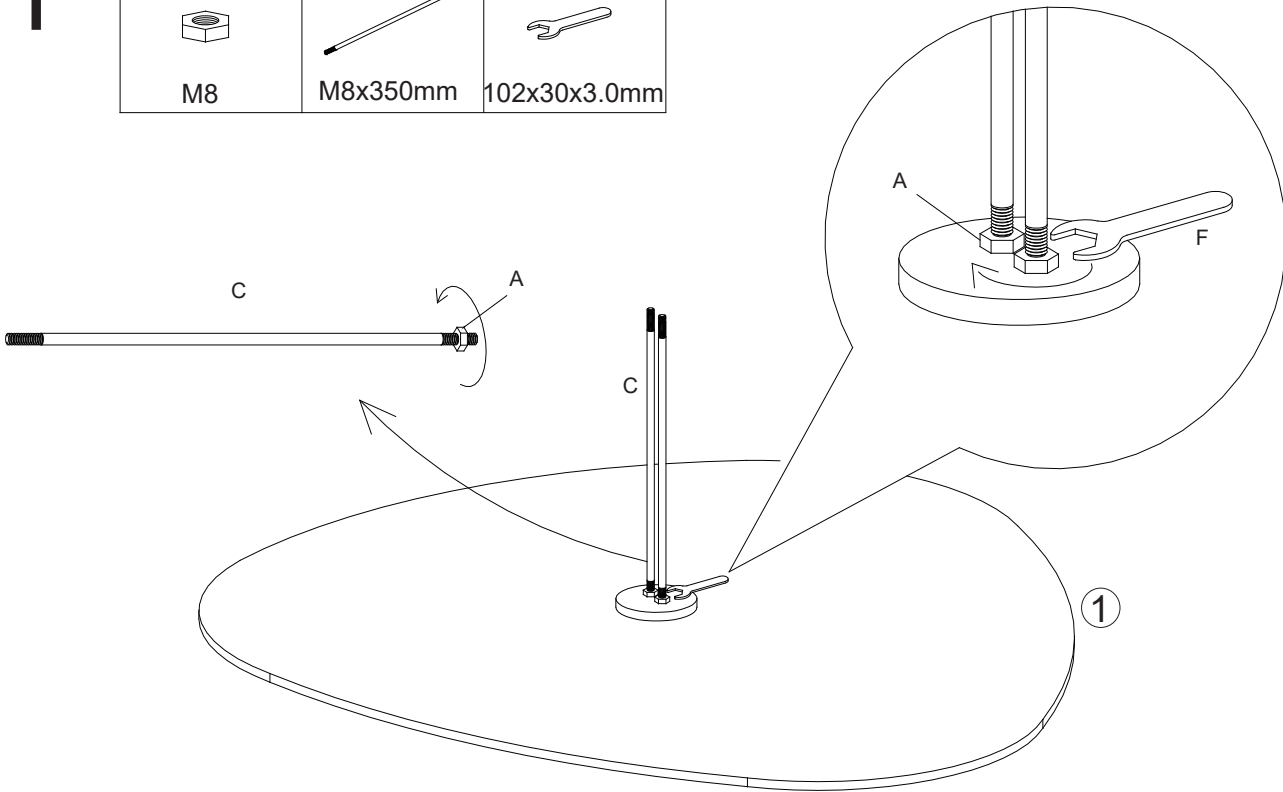

<p>A x 4</p>  <p>M8</p>	<p>B x 2</p>  <p>$\phi 16 \times \phi 8.5 \times 2.0 \text{mm}$</p>	<p>C x 2</p>  <p>M8x350mm</p>	<p>D x 2</p>  <p>$\phi 13 \times \phi 8.5 \times 2.0 \text{mm}$</p>	<p>E x 1</p>  <p>$\phi 16 \times 90 \text{mm}$</p>
<p>F x 1</p>  <p>102x30x3.0mm</p>				

1

A x 2	C x 2	F x 1
		
M8	M8x350mm	102x30x3.0mm



2

A x 2	B x 2	D x 2	E x 1
			
M8	φ16xφ8.5x2.0mm	φ13xφ8.5x2.0mm	φ16x90mm

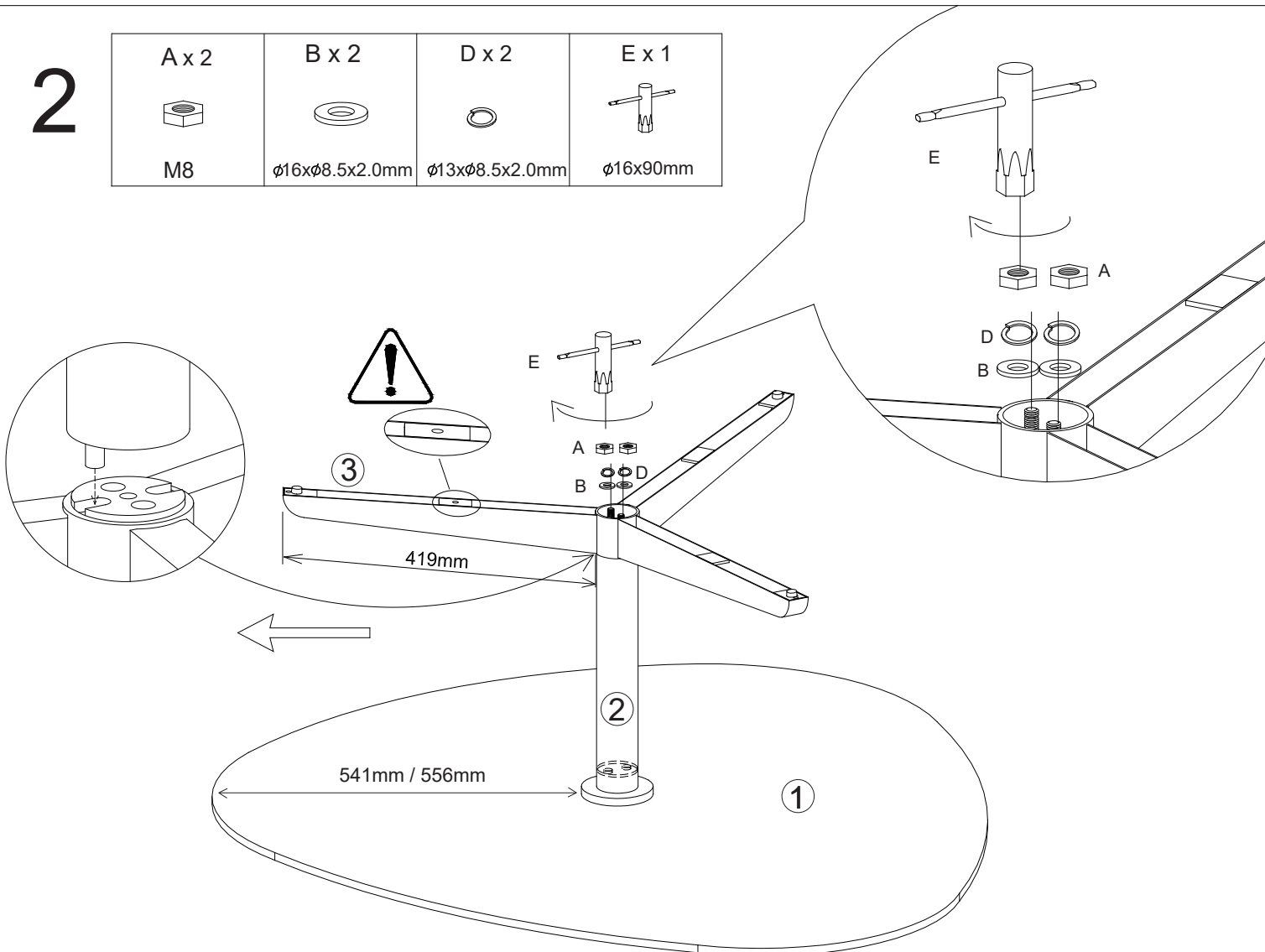

3

