













# ASSEMBLY INSTRUCTIONS



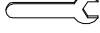





Thank you for purchasing this quality product. Be sure to check all packing material carefully for small parts that may have come loose inside the carton during shipment.

## HARDWARE/PARTS LOCATION

### QUEEN-STORAGE BENCH FOOTBOARD

- > Bracket foot > Inside labeled inner carton > Placed at right side of the footboard
- > Support leg > Inside labeled inner carton > Placed at left side of the footboard
- > Step 1,2,3 & 5 hardware > Inside red pack with red tape > Placed at inside the leg box

NO.	HARDWARE LIST	Q'TY
A	 Ø5/16"X16X2mm Flat washer	8
B	 Ø5/16"X19X2mm Flat washer	4
C	 Ø5/16"X12X2mm Spring washer	12
D	 Ø5/16"X3-1/2" Bolt	8
E	 29*15*7.5 Half Moon Washer	8
F	 Ø5/16" X12mm Hex Nut	8
G	 Ø5/16" Wrench	1
H	 #8x1" Screw	26
I	 Ø1/4"X16X2mm Flat washer	6
J	 Ø1/4"X10X2mm Spring washer	6
K	 Ø1/4"X32mm Bolt	6
L	 4mm Allen wrench	1
M	 Ø5/16"X76mm Bolt	4

NO.	PARTS LIST	Q'TY
1	 Headboard	1
2	 Side rails	2
3	 Footboard	1
4	 Support leg	4
5	 Slat roll	1
6	 Support leg (167*32*32mm)	3
7	 Left Bracket Foot	1
8	 Right Bracket Foot	1

### TOOLS REQUIRED (NOT PROVIDED)

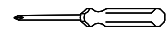

Screw Driver

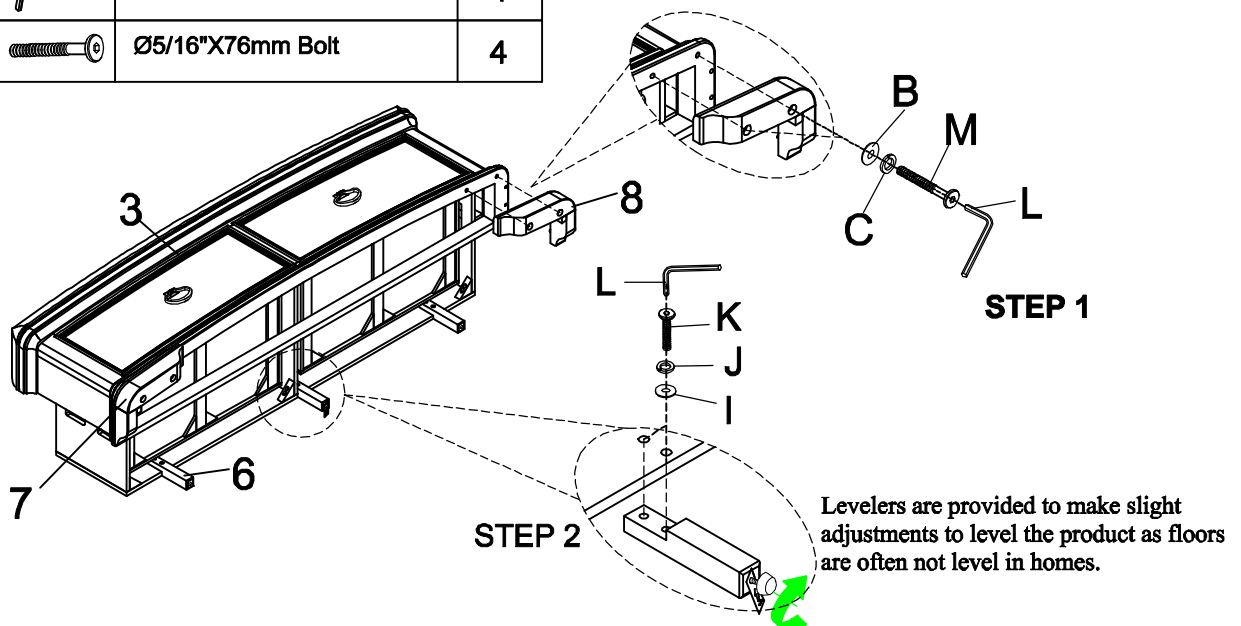

Do not fully tighten all screws and bolts until the entire item is completely assembled.

# ASSEMBLY INSTRUCTIONS

Thank you for purchasing this quality product. Be sure to check all packing material carefully for small parts that may have come loose inside the carton during shipment.

**NOTE:** All Platform and Storage Beds require a bunkie board or plywood platform to be used on top of the slats and below the mattress

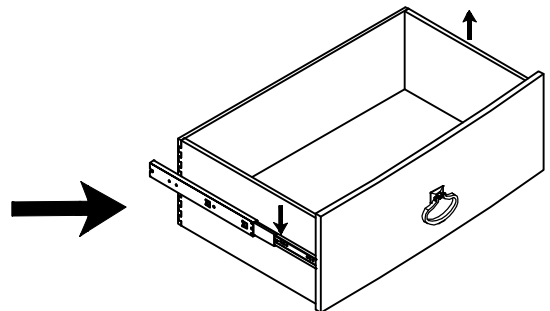
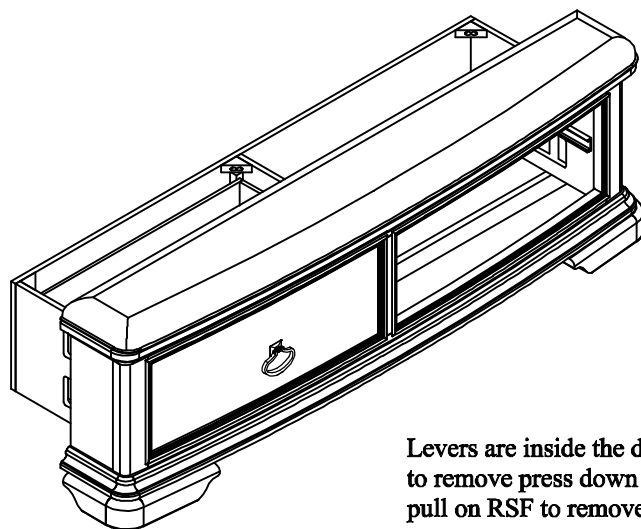
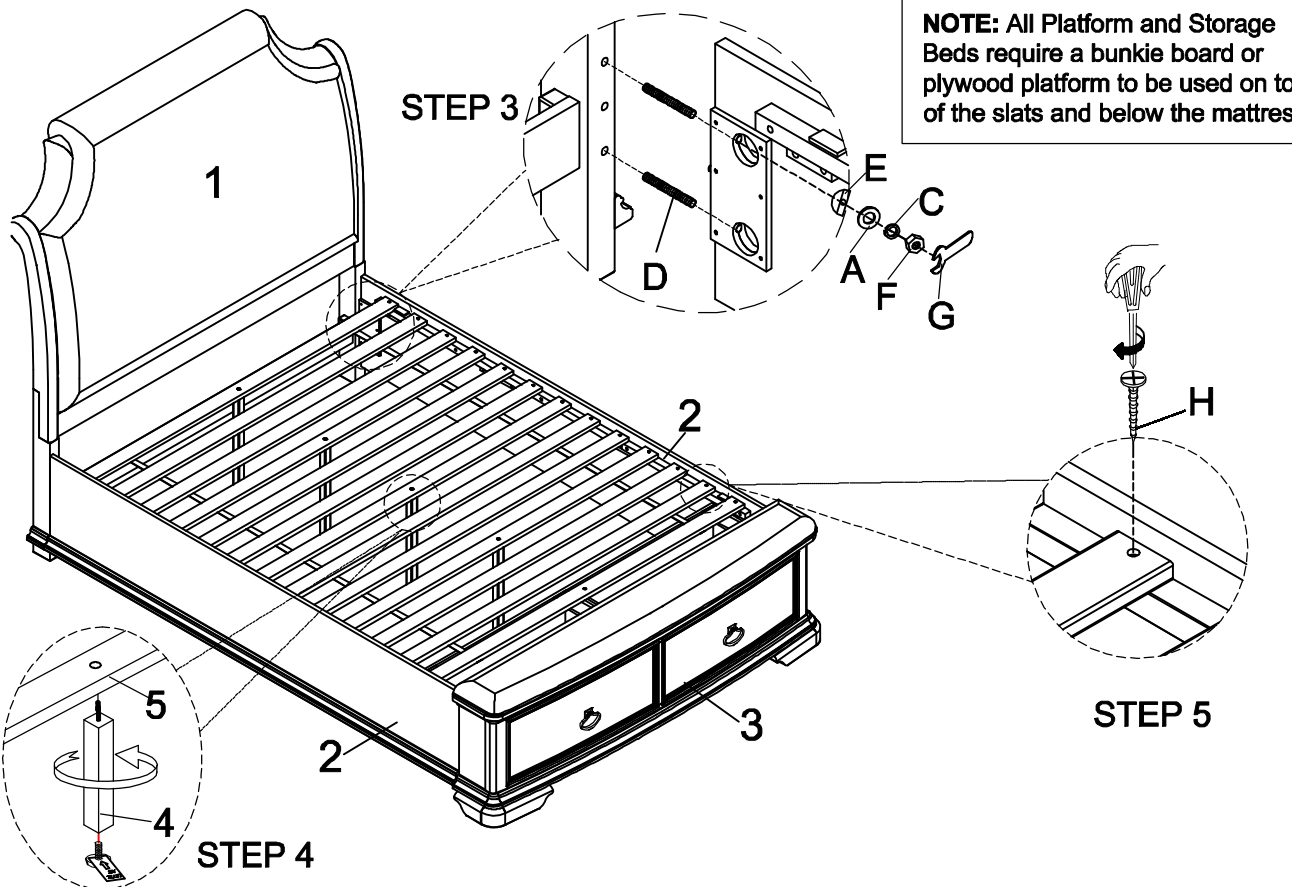

Levers are inside the drawer glide, to remove press down on LSF and pull on RSF to remove drawer.

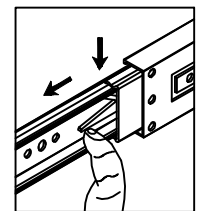
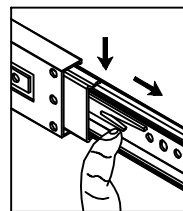

Do not fully tighten all screws and bolts until the entire item is completely assembled.