

Assembly Instructions

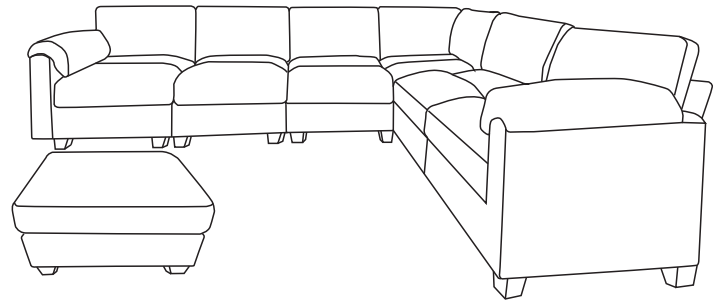
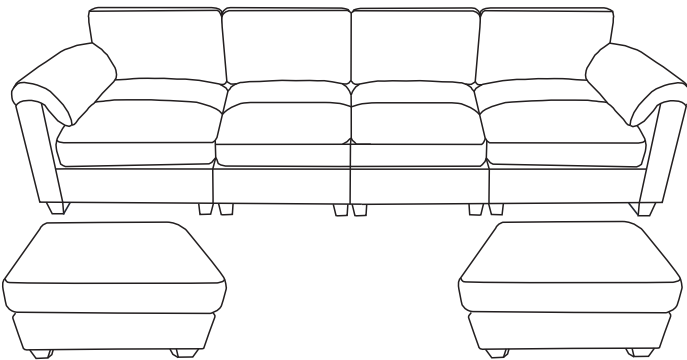
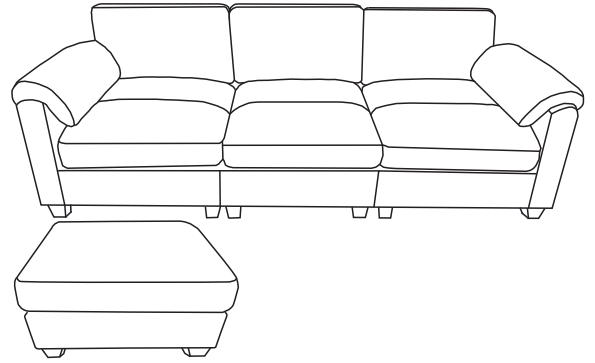
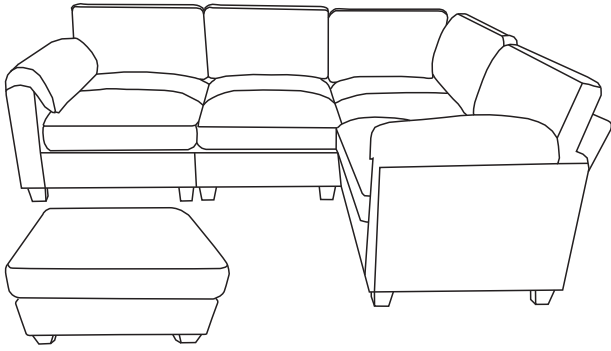

NOTE: Please read these instructions carefully before starting assembly

HASSEL-FREE WARRANTY

We proudly provide 1-YEAR warranty, if there are any questions with the products, please feel free to contact with us.



The assembly will be easier with 2 people while 1 person could also do the job.



Around 10 MIN ASSEMBLY

MAINTENANCE AND WARNING

- Keep furniture away from heat sources.
- Do not clean furniture with harsh cleaner or polishes. Do not use detergents, Solvents, abrasives, spray packs or leather cleaner. Use non-color mild soap with warm water to clean spills(Mix 1:10 soap to water)
- Do not place furniture under direct sunlight, material will possibly fade over time.
- Do not use on site dry Cleaning machine.
- Children should not climb or jump on the furniture.
- Do not write on furniture that is not protected by a padded barrier .







Weight Limitation











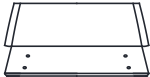

250LBS per seat

PART LIST & HARDWARE

1

<p>A Left Armrest</p>  <p>1PC</p>	<p>B Right Armrest</p>  <p>1PC</p>	<p>P M8*35mm Bolt</p>  <p>8PCS</p>	<p>T Washer φ22*φ8*2mm</p>  <p>8PCS</p>	<p>U Alley key</p>  <p>1PC</p>
---	--	--	---	--











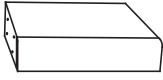

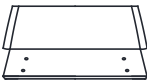

2

<p>C Seat frame</p>  <p>2PCS</p>	<p>F Back frame</p>  <p>2PCS</p>	<p>G Seat cushion</p>  <p>2PCS</p>	<p>J Back cushion</p>  <p>2PCS</p>	<p>M Connector</p>  <p>4PCS</p>
<p>N Supporting feet</p>  <p>8PCS</p>	<p>O Gasket</p>  <p>8PCS</p>	<p>Q M8*20mm Bolt</p>  <p>16PCS</p>	<p>R M8*70mm Bolt</p>  <p>4PCS</p>	<p>S Butterfly nut</p>  <p>8PCS</p>
<p>T Washer φ22*φ8*2mm</p>  <p>8PCS</p>	<p>V Washer φ22*φ8*1.5mm</p>  <p>16PCS</p>	<p>U Alley key</p>  <p>1PC</p>		











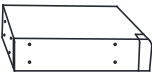



Be sure to inspect all packing material carefully for small parts, that may have come loose inside the carton during shipment.

PART LIST & HARDWARE

3

<p>C Seat frame</p>  <p>1PC</p>	<p>D Ottoman frame</p>  <p>1PC</p>	<p>F Back frame</p>  <p>1PC</p>	<p>G Seat cushion</p>  <p>1PC</p>	<p>H Ottoman cushion</p>  <p>1PC</p>
<p>J Back cushion</p>  <p>1PC</p>	<p>M Connctor</p>  <p>2PCS</p>	<p>N Supporting feet</p>  <p>8PCS</p>	<p>O Gasket</p>  <p>8PCS</p>	<p>Q M8*20mm Bolt</p>  <p>8PCS</p>
<p>R M8*70mm Bolt</p>  <p>2PCS</p>	<p>S Butterfly nut</p>  <p>4PCS</p>	<p>T Washer φ22*φ8*2mm</p>  <p>8PCS</p>	<p>V Washer φ22*φ8*1.5mm</p>  <p>8PCS</p>	<p>U Alley key</p>  <p>1PC</p>

4

<p>E Corner seat frame</p>  <p>1PC</p>	<p>F Back frame</p>  <p>2PCS</p>	<p>I Corner seat cushion</p>  <p>1PC</p>	<p>K Left corner cushion</p>  <p>1PC</p>	<p>L Right corner cushion</p>  <p>1PC</p>
<p>M Connctor</p>  <p>4PCS</p>	<p>N Supporting feet</p>  <p>4PCS</p>	<p>O Gasket</p>  <p>4PCS</p>	<p>Q M8*20mm Bolt</p>  <p>16PCS</p>	<p>R M8*70mm Bolt</p>  <p>2PCS</p>
<p>S Butterfly nut</p>  <p>4PCS</p>	<p>T Washer φ22*φ8*2mm</p>  <p>4PCS</p>	<p>V Washer φ22*φ8*1.5mm</p>  <p>16PCS</p>	<p>U Alley key</p>  <p>1PC</p>	<p>W Velcro</p>  <p>2PCS</p>

Be sure to inspect all packing material carefully for small parts, that may have come loose inside the carton during shipment.

ASSEMBLY INSTRUCTIONS

STEP 1: Assemble the Left armrest (A) to the seat frame (C) with Washers (T) and Bolt (P).

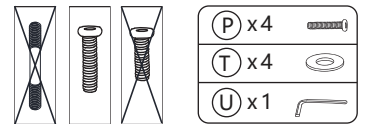
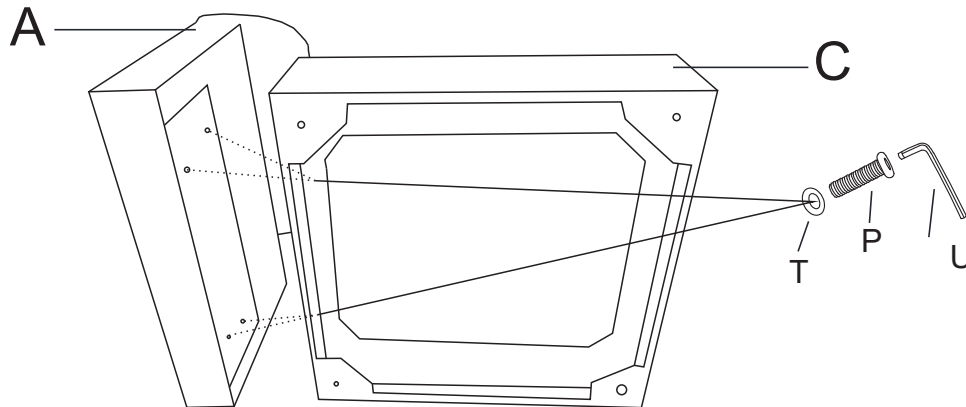

STEP 2: Assemble the Right armrest (B) to the seat frame (C) with Washers (T) and Bolt (P).

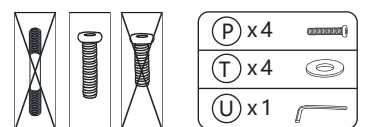
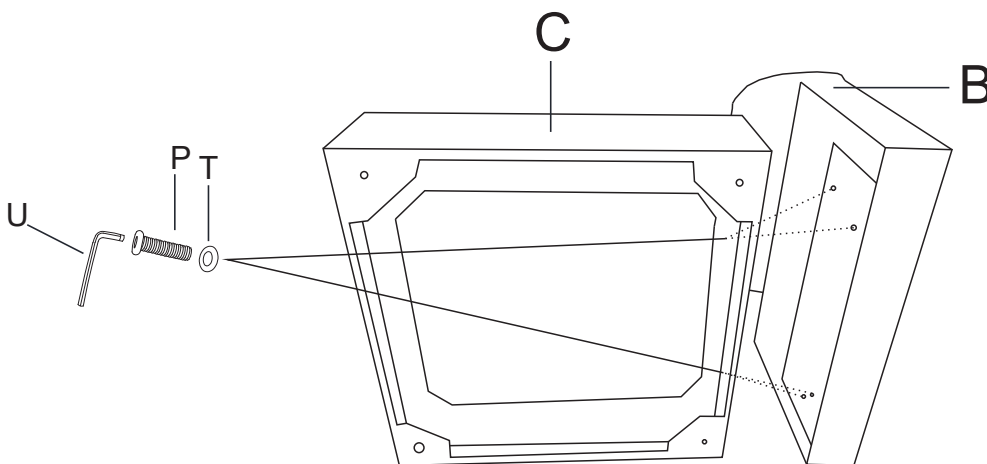

STEP 3 :Connect the Corner seat frame (E) the Seat frame (C) with Butterfly nut (S) Washers (T) and Bolt (R).

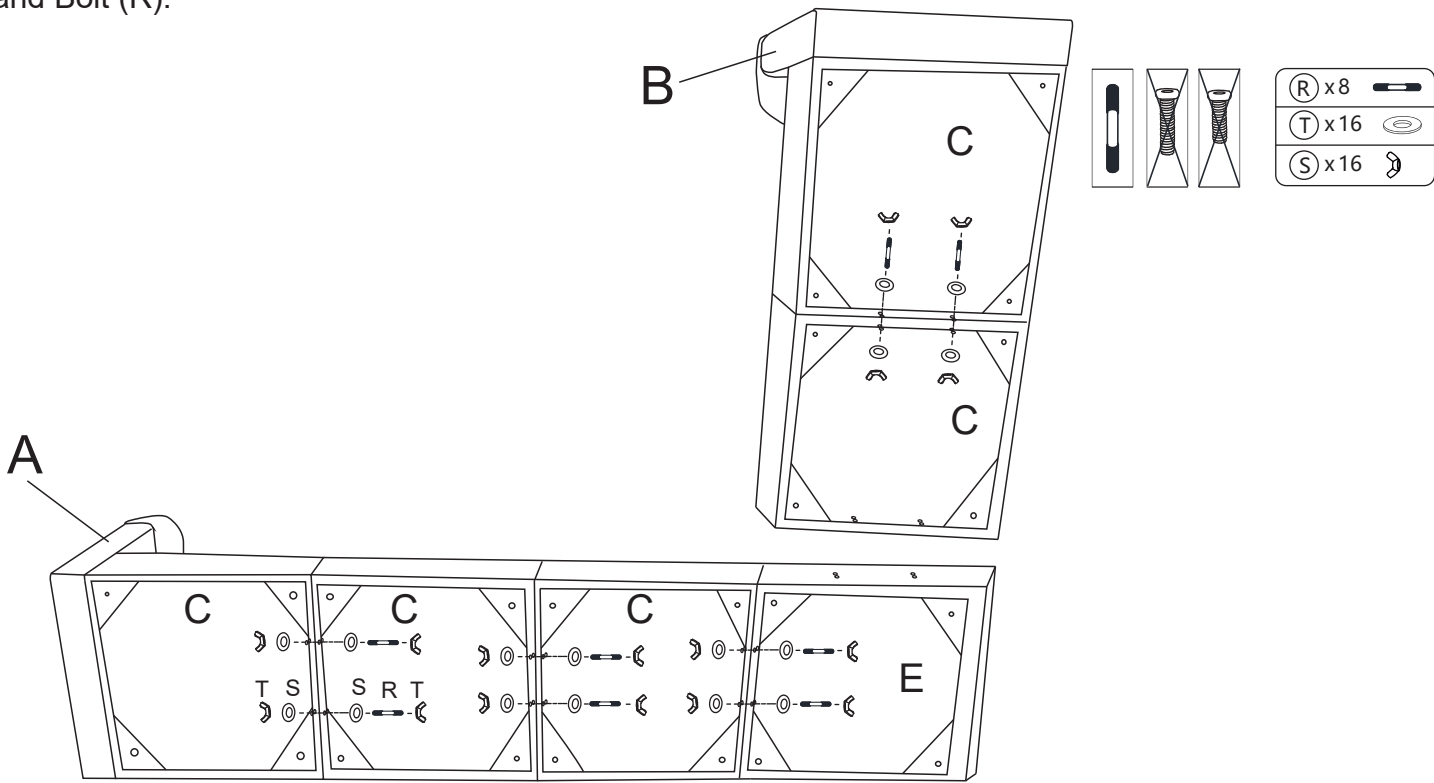

If you buy a multi-seater sofa, the assembly process is the same as loveseat sofa.

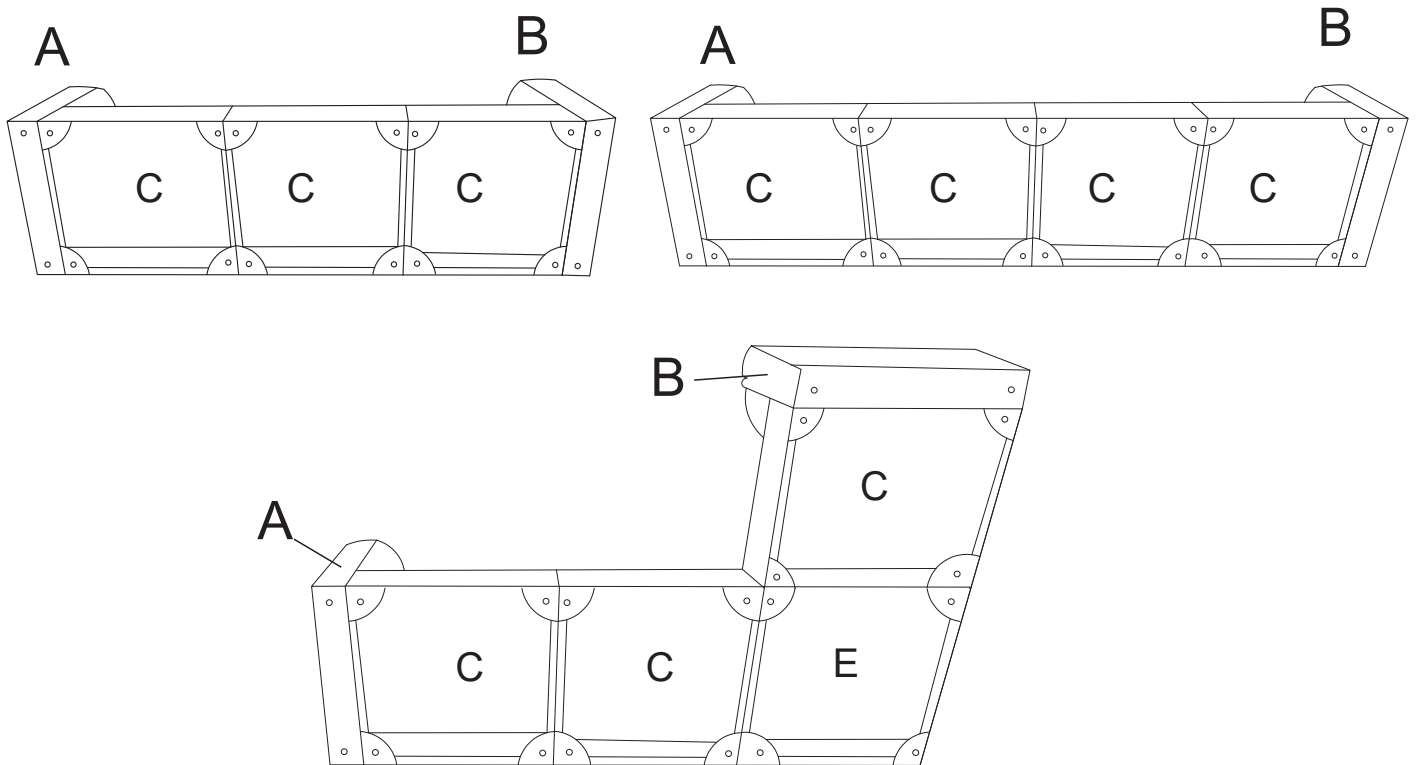

STEP 4: Screw the Supporting feet (N) with Gasket (O).

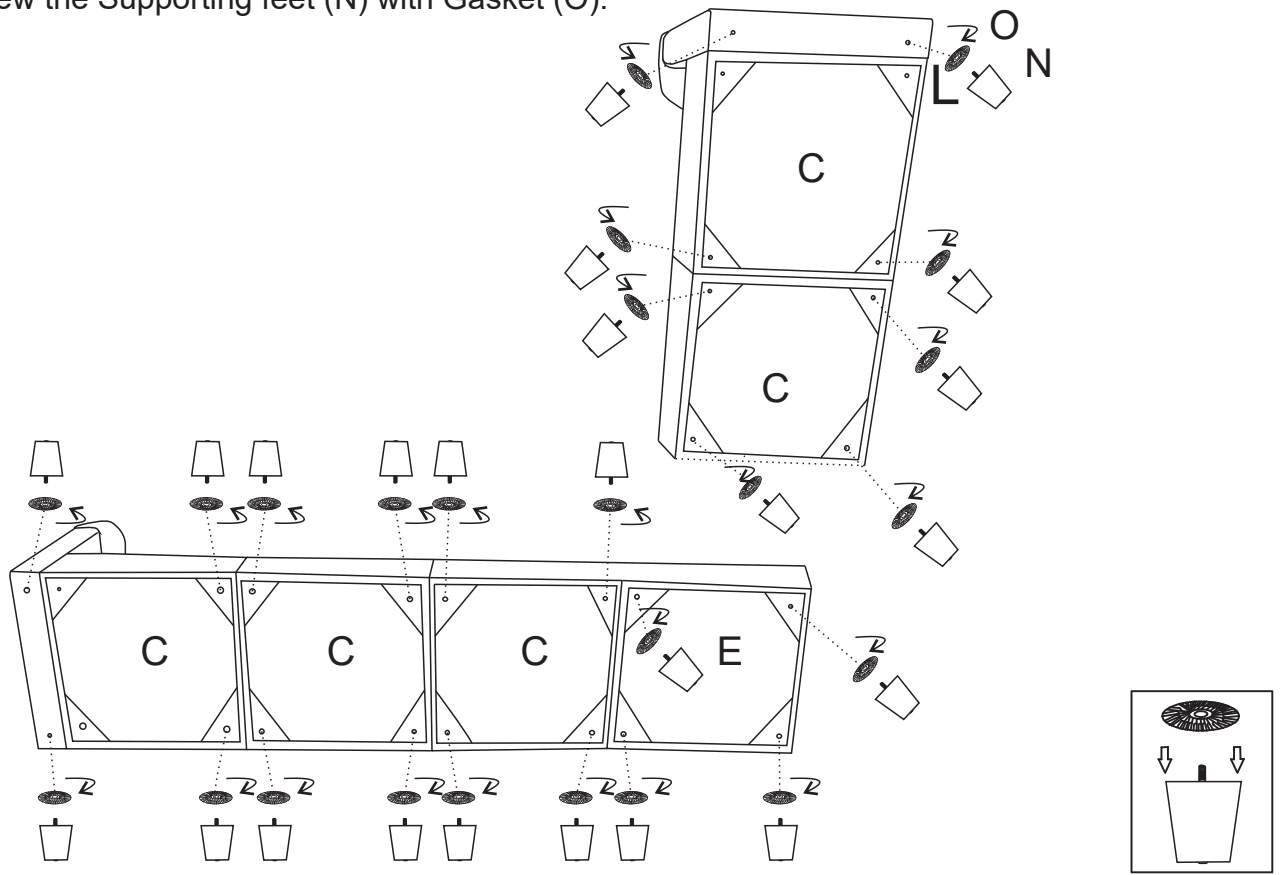

If you buy a multi-seater sofa, the assembly process is the same as loveseat sofa.

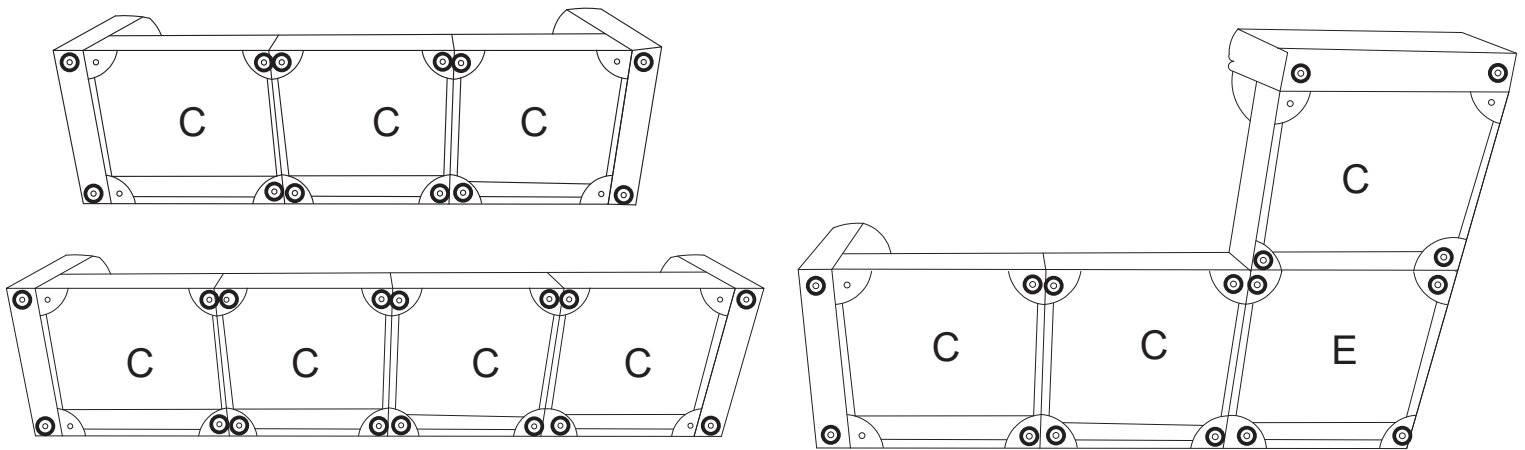

STEP 5: Assemble the Legs (N) on the ottoman frame with Gaskets (O)

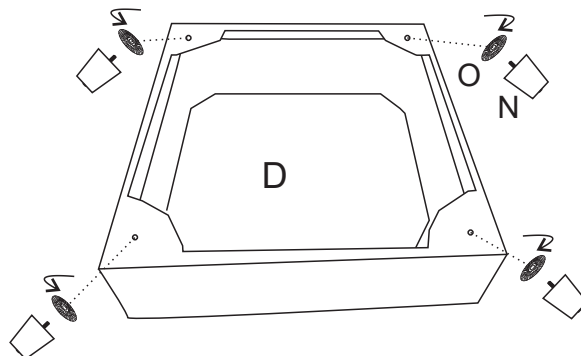

STEP 6: Assemble the Connector (M) to the Back frame (F) with Washers (V) and Bolt (Q).

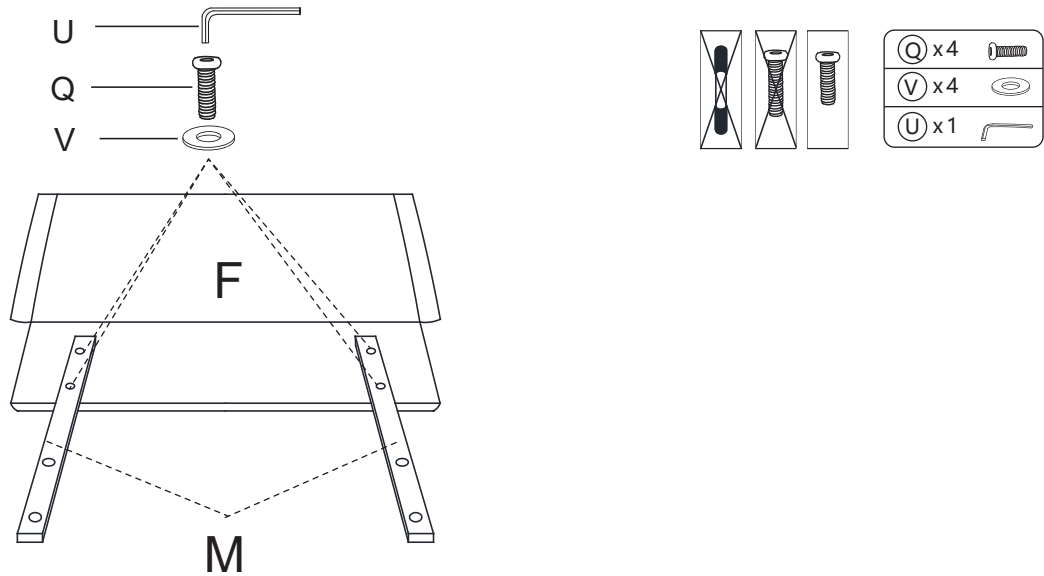

STEP 7: Attach the assembled backrest frame to the all seat frame.

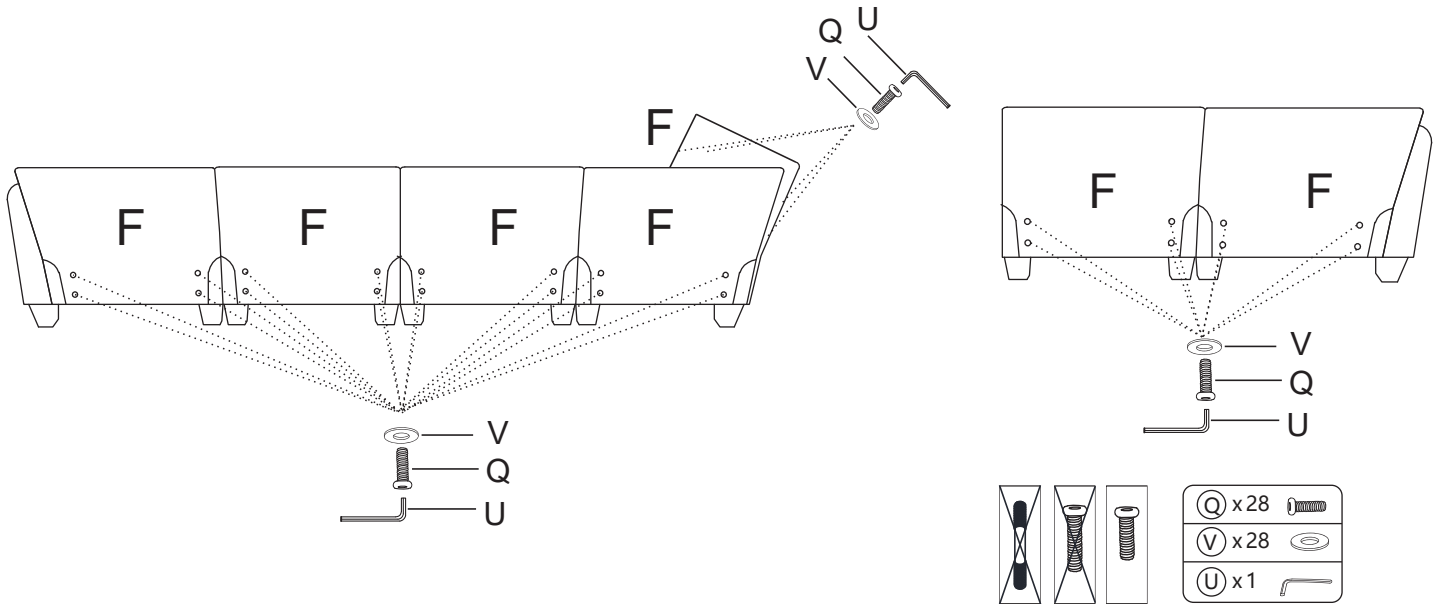

If you buy a multi-seater sofa, the assembly process is the same as loveseat sofa.

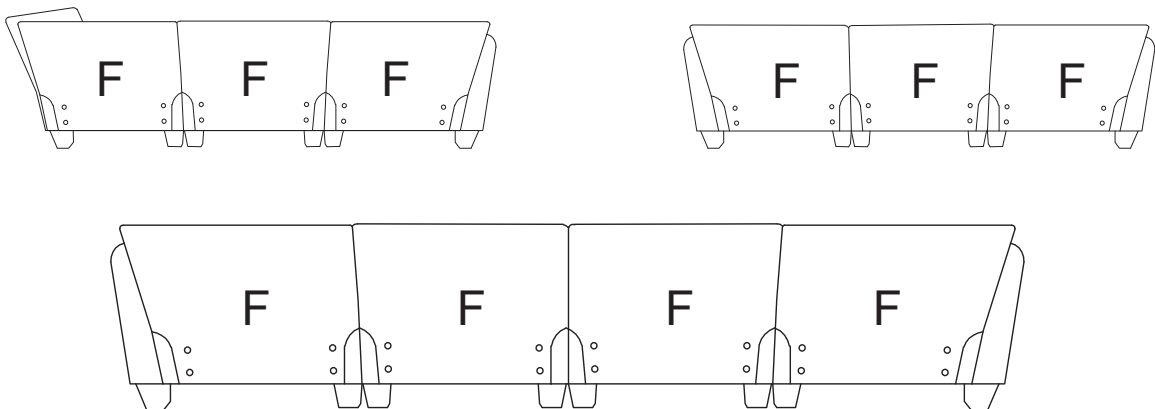

STEP 8: Stick the Velcro of the backrest to the seat frame.

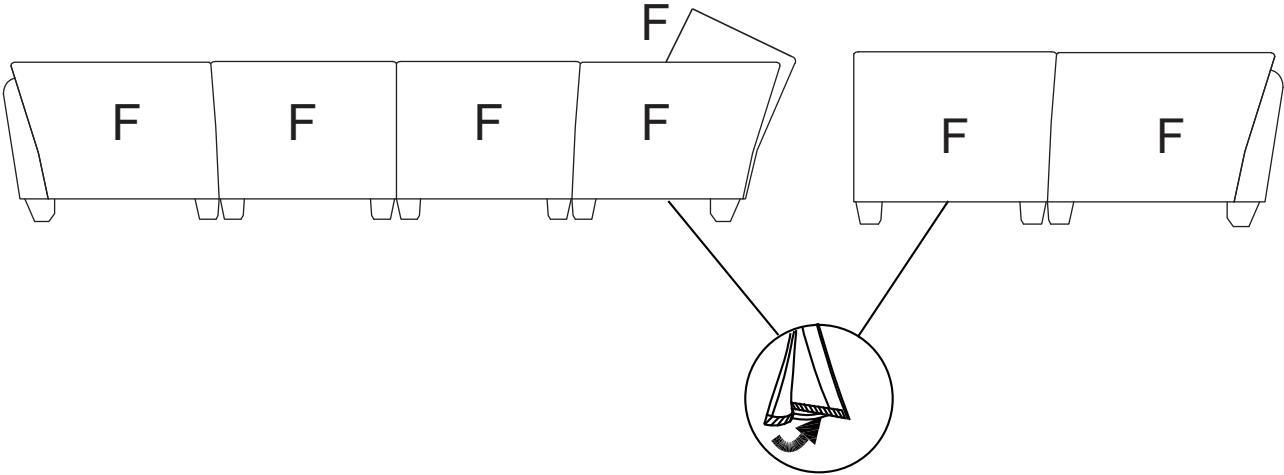

If you buy a multi-seater sofa, the assembly process is the same as loveseat sofa.

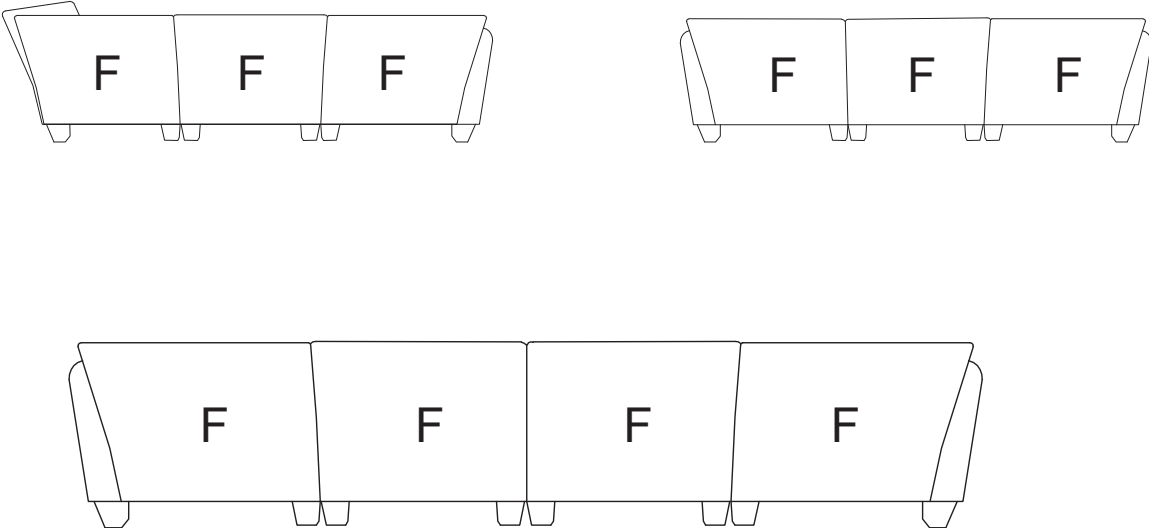

STEP 9: Connect the Corner seat frame (E) with Velcro (W).

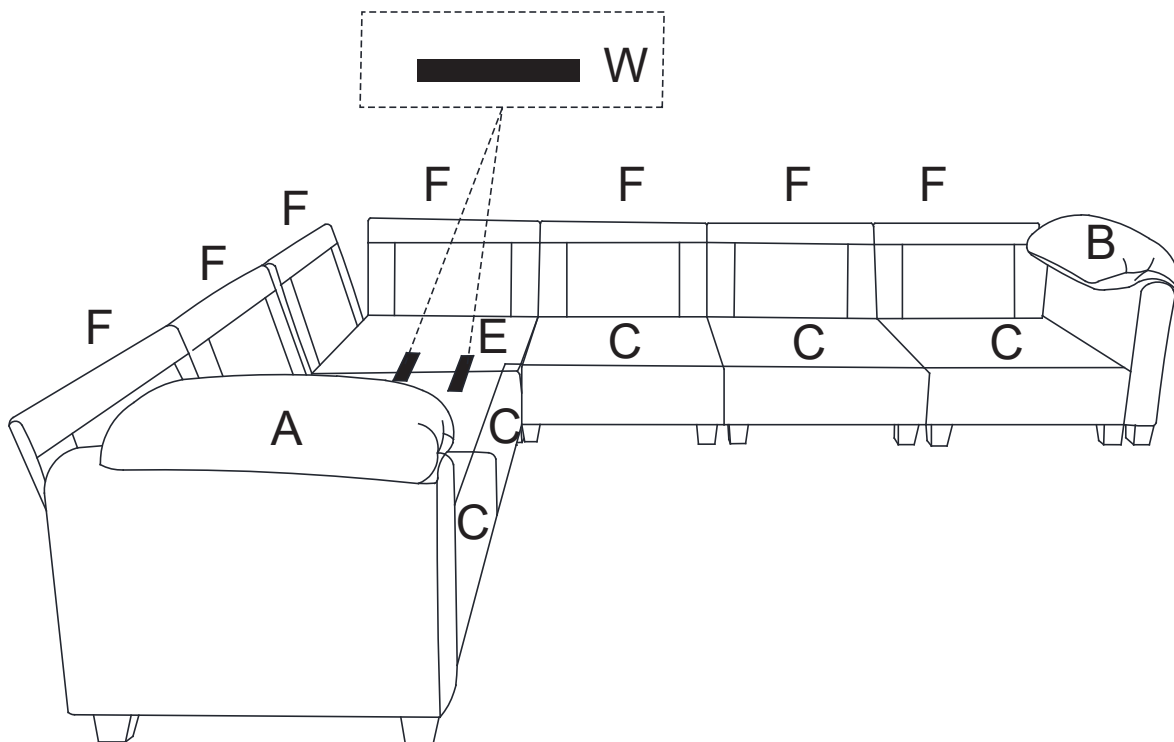

If you buy a multi-seater sofa, the assembly process is the same as loveseat sofa.

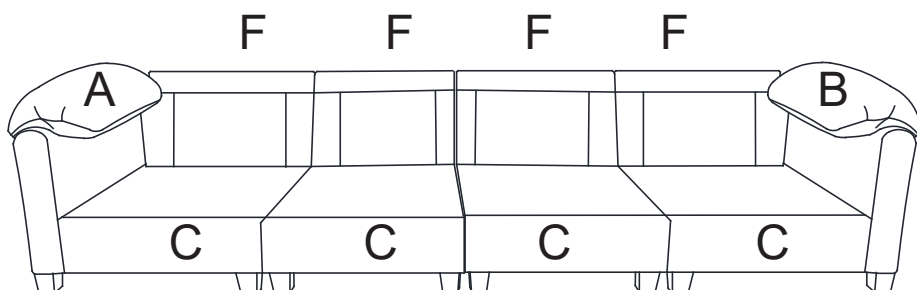
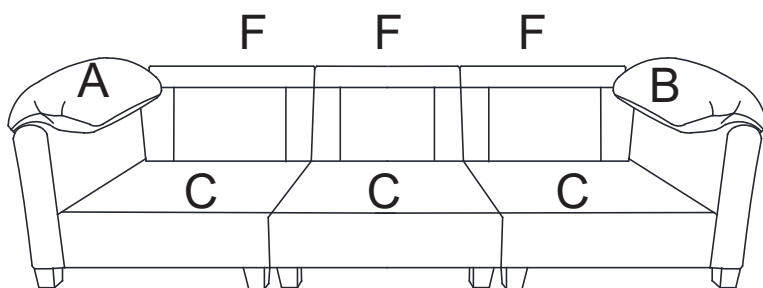
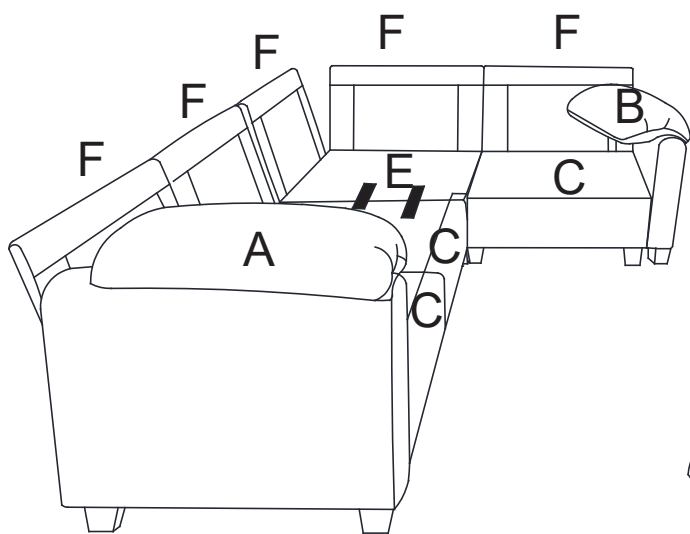

STEP 10: The cushions are packaged by vacuum compression. After cutting the package, it rebounds quickly within 4 hours. If the fabric has wrinkles, it will basically disappear after standing for 72 hours.

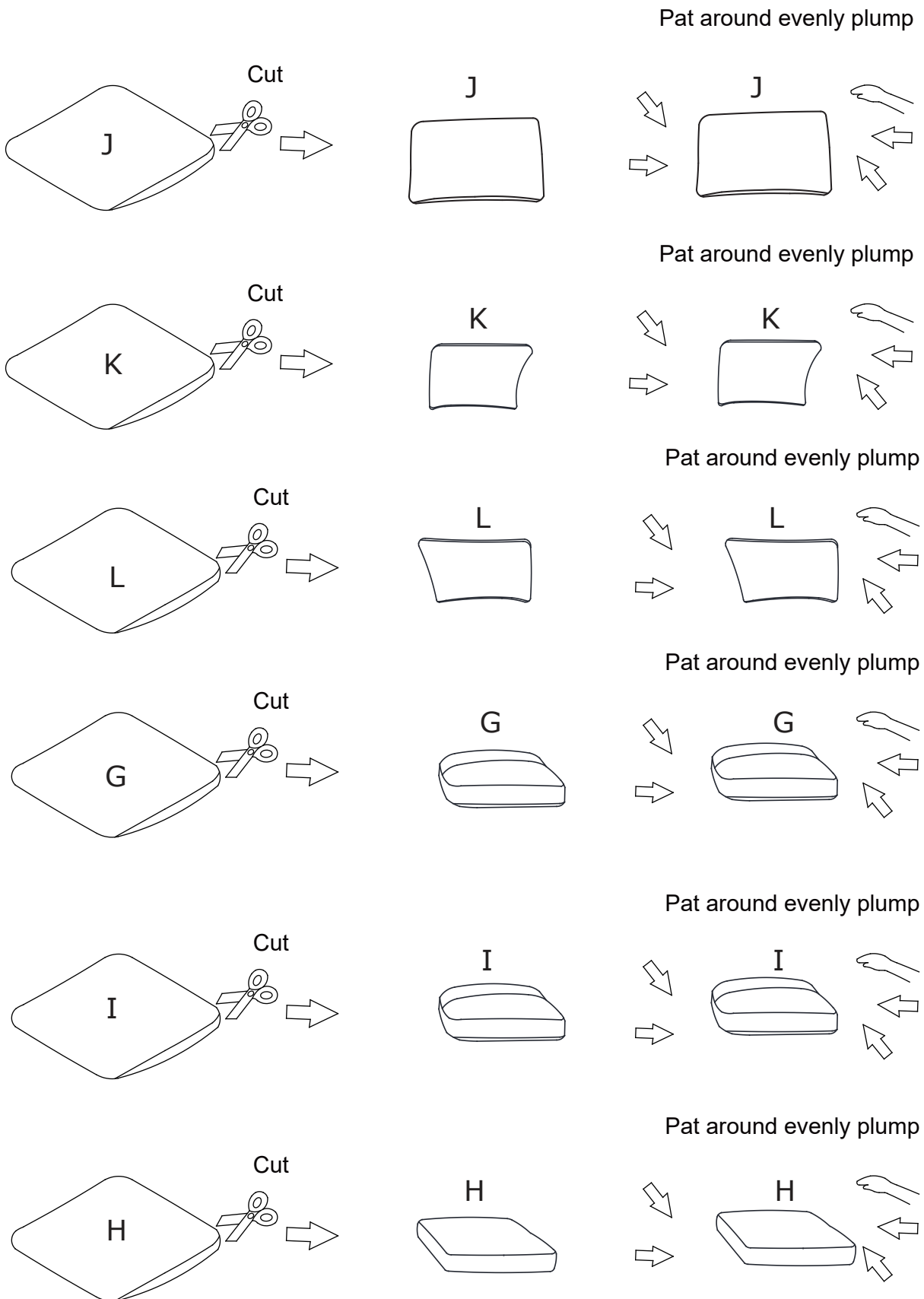

STEP 11: Put all the cushions to the sofa.

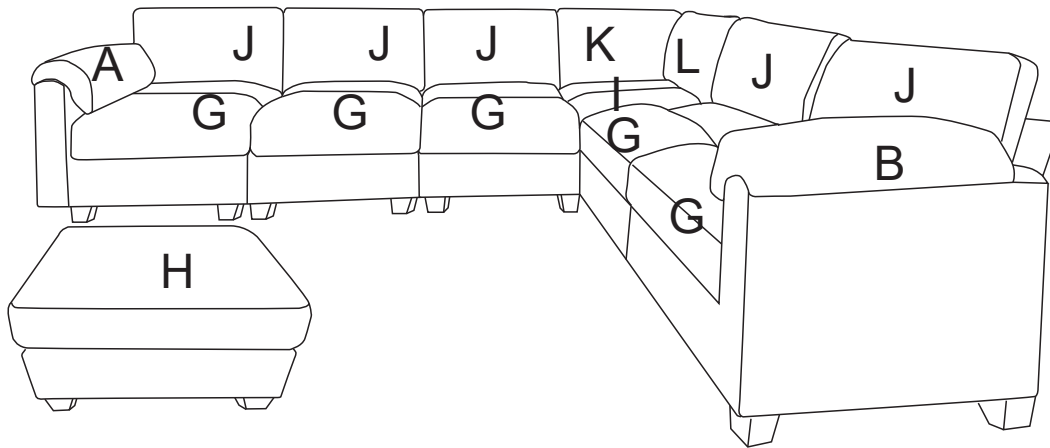

COMPLETED!

