

# ASSEMBLY INSTRUCTION

## ▽ ASSEMBLY PROGRAM

1

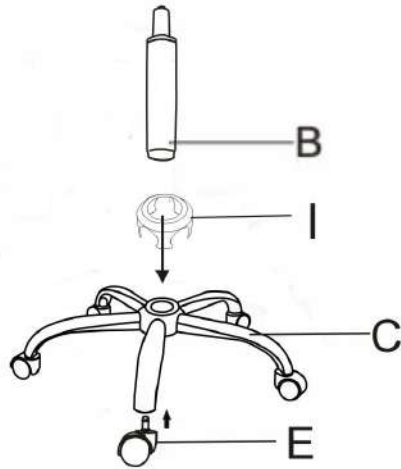

2

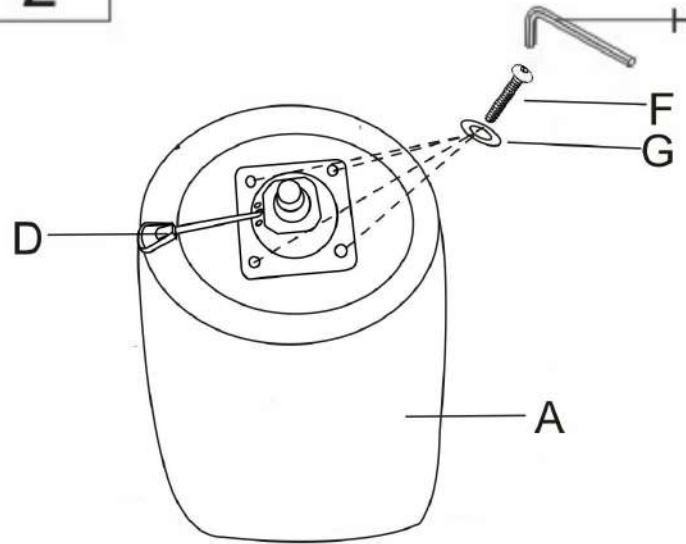

3

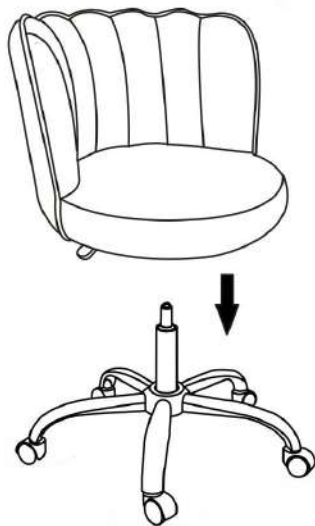

4

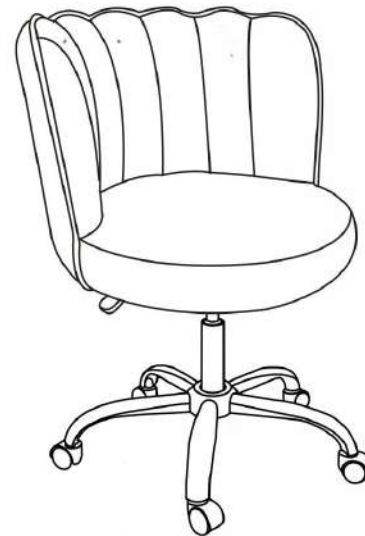

## ▽ PARTSxQTY

Ax1

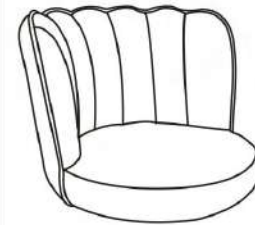

Ex5

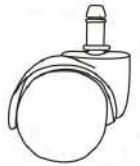

Bx1

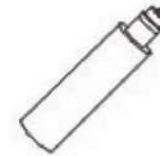

Fx4



Cx1



Gx4



Hx1



Dx1

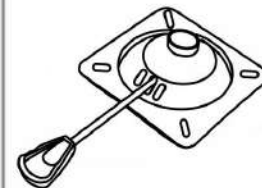

Ix1

