

Assembly Manual / Guide d'assemblage /
Manual de ensamblaje / 조립설명서 /
Montageanleitung

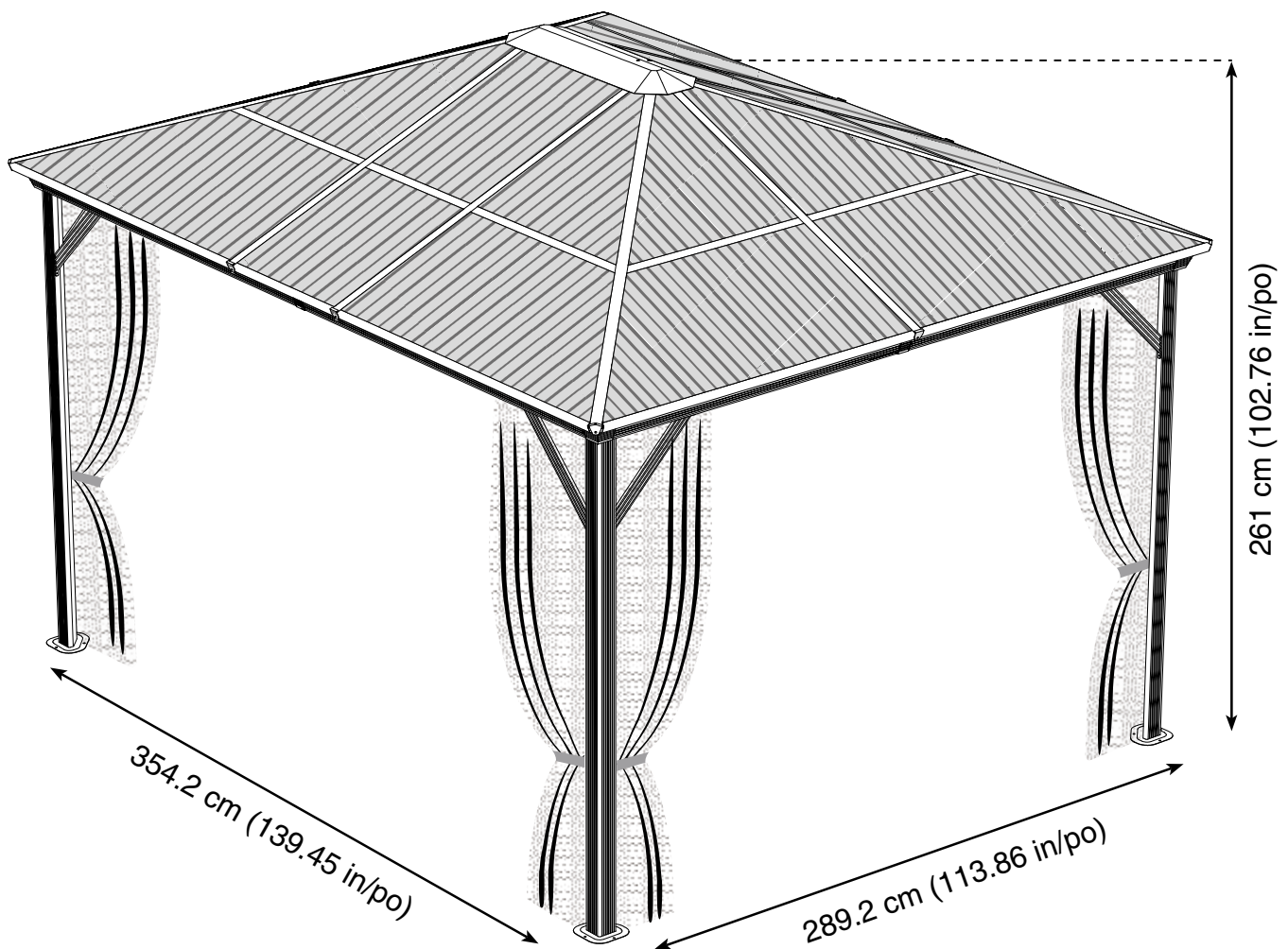

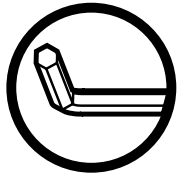

Use the hex keys in the box. / Utilisez les clés hexagonales fournies dans la boîte. / Utilice las llaves hexagonales en la caja. / 상자에 육각 키를 사용 하십시오. / Verwenden Sie die Sechskantschlüssel in der Box.

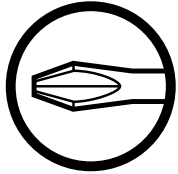

Please use a Phillips screwdriver. / Utilisez un tournevis de type Phillips / Por favor, use un destornillador Phillips. / 십자 드라이버를 사용 하십시오. / Bitte verwenden Sie einen Kreuzschraubenzieher.



You may need to use a drill for this step. / Vous pouvez avoir besoin d'utiliser une perceuse pour cette étape. / Puede que tenga que utilizar un taladro para este paso. / 이 단계에선 드릴을 사용해야 할 수도 있습니다. / Für diesen Schritt können Sie einen Bohrer verwenden.



Wearing protective gloves is recommended. / Le port de gants de protection est recommandé / El uso de guantes de protección se recomienda. / 보호 장갑을 착용 하는 것이 좋습니다. / Das Tragen von Schutzhandschuhen wird empfohlen.



Two or more people are required at this stage. / Deux personnes ou plus sont nécessaires à cette étape. / Dos o más personas se requieren en esta etapa. / 이 단계에서는 두 명 이상 이 필요합니다. / Für diesen Bauschritt sind 2 oder mehr Personen erforderlich.



Do not tighten screws all the way for now. / Ne pas visser fermement pour l'instant. / No atornille con firmeza por ahora. / 아직 나사를 단단히 조이지 마십시오. / Bitte die Schrauben zum jetzigen Zeitpunkt noch nicht fest anziehen.

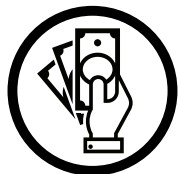

Sold separately. / Vendus séparément. / vendido en las opciones. / 옵션 판매 / Optional erhältlich



Optional step / Étape optionnelle / Paso opcional / 선택적 단계 / Optionaler Schritt

T X 8 (+2)

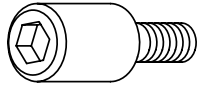

U X 16 (+2)

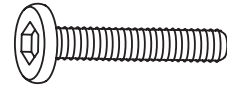

U1 X 1 (+1)

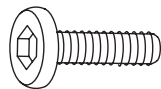

U2 X 2 (+1)

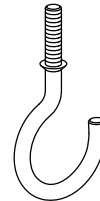

V X 64 (+7)

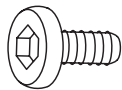

V1 X 16 (+2)

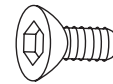

V2 X 20 (+2)

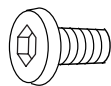

W X 24 (+3)

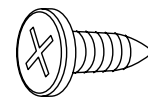



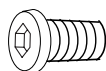



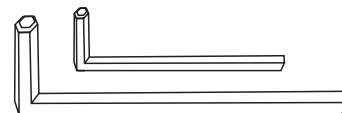

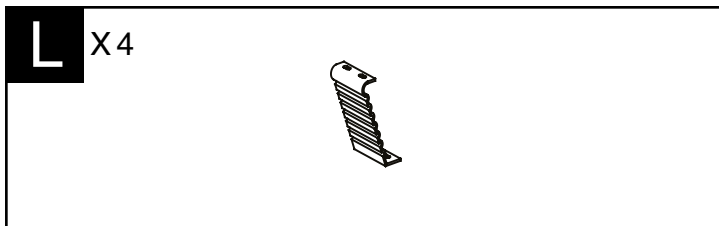
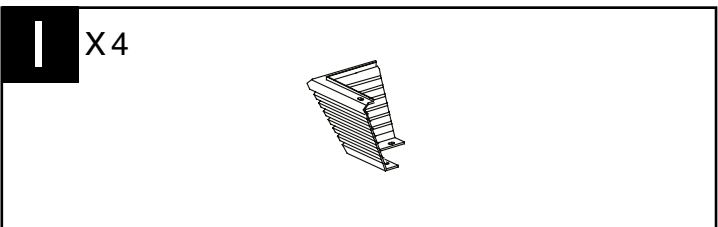
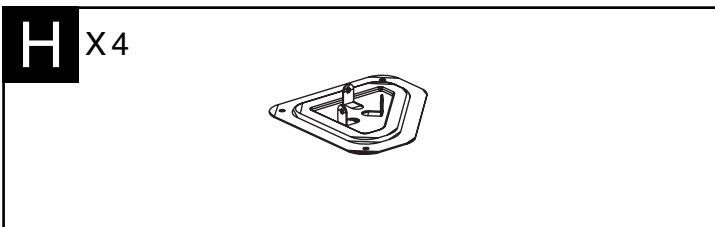
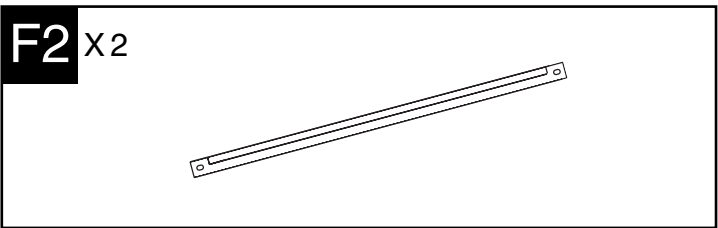
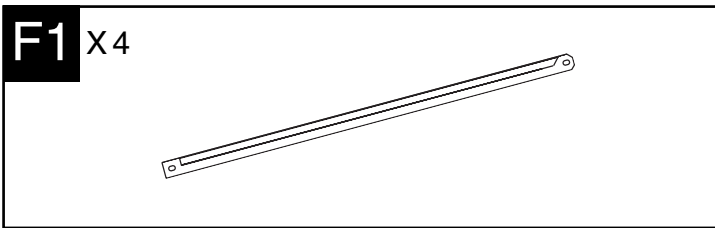
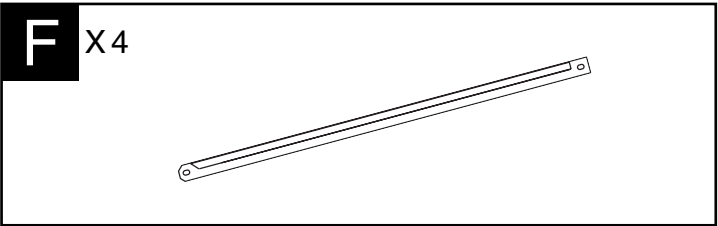
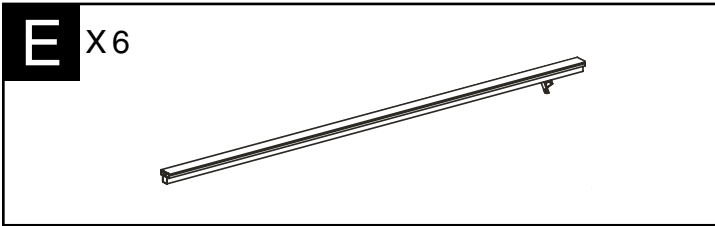
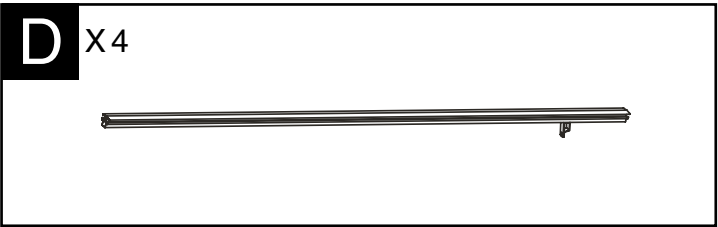
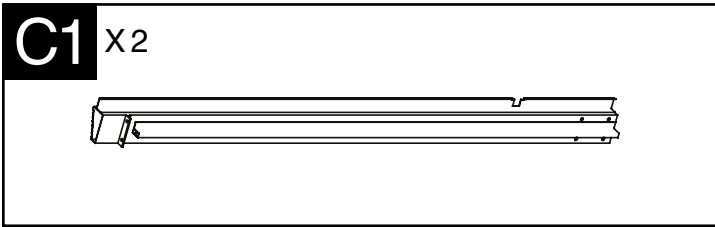
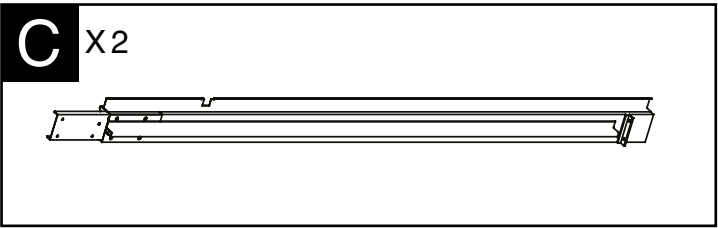
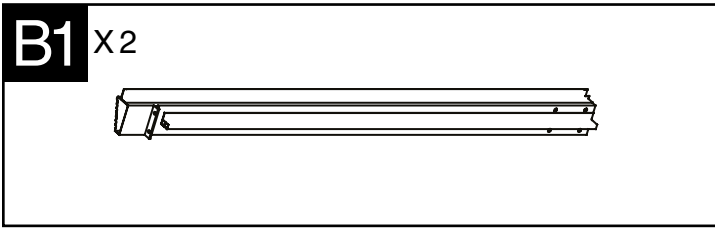
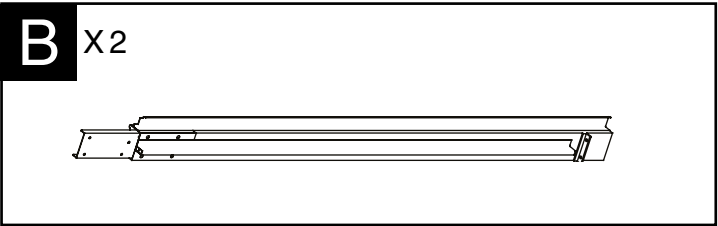
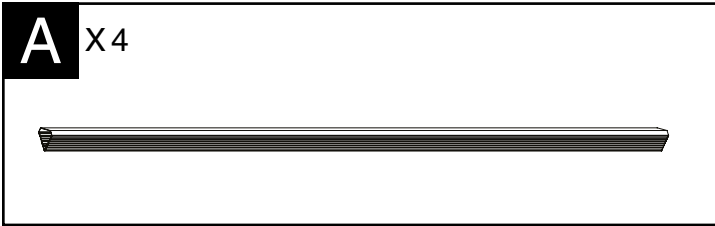

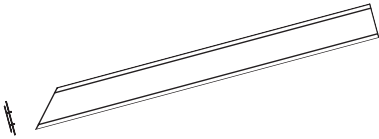
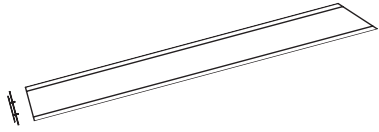
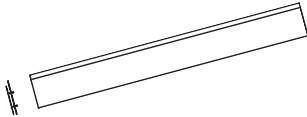
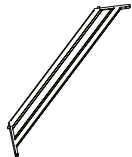
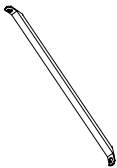

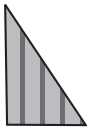
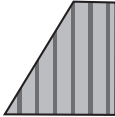
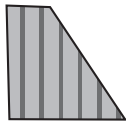
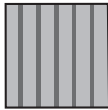
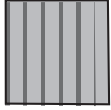
W1 X 16 (+2)

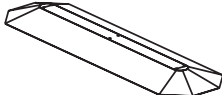
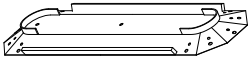

Y X 1

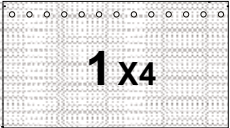

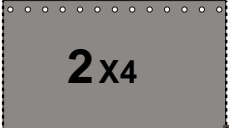

| | | |
|---|---|---|
| J X4  | J1 X4  | |
| J2 X2  | K X8  | |
| K2 X4  | Ma X4  | |
| Na X4  | Mb X4  | |
| Nb X4  | Z X2  | Z1 X2  |
| Q X4  | R X6  | S X1  |
| S1 X1  | X X52 optional   X X52 optional  | |
| Net  1 X4  optional | Curtain  2 X4  optional | |

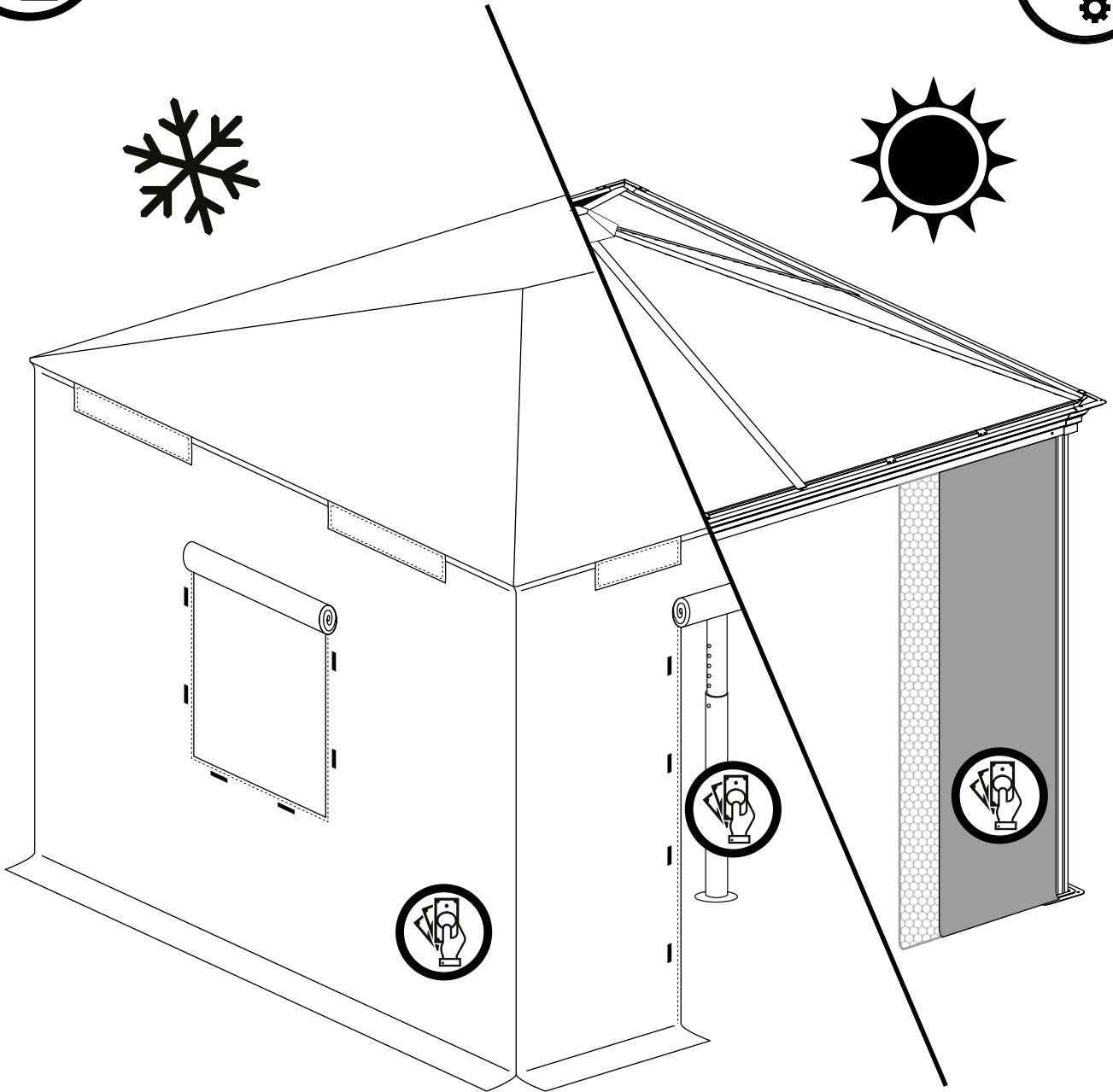
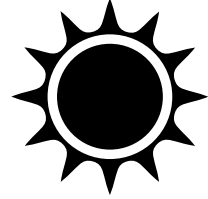
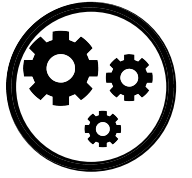
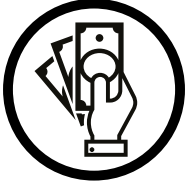

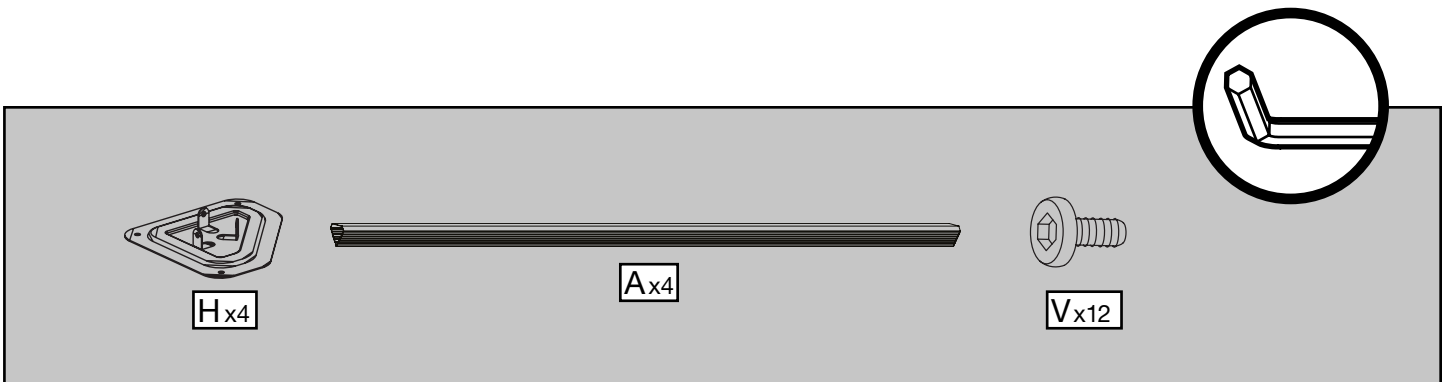
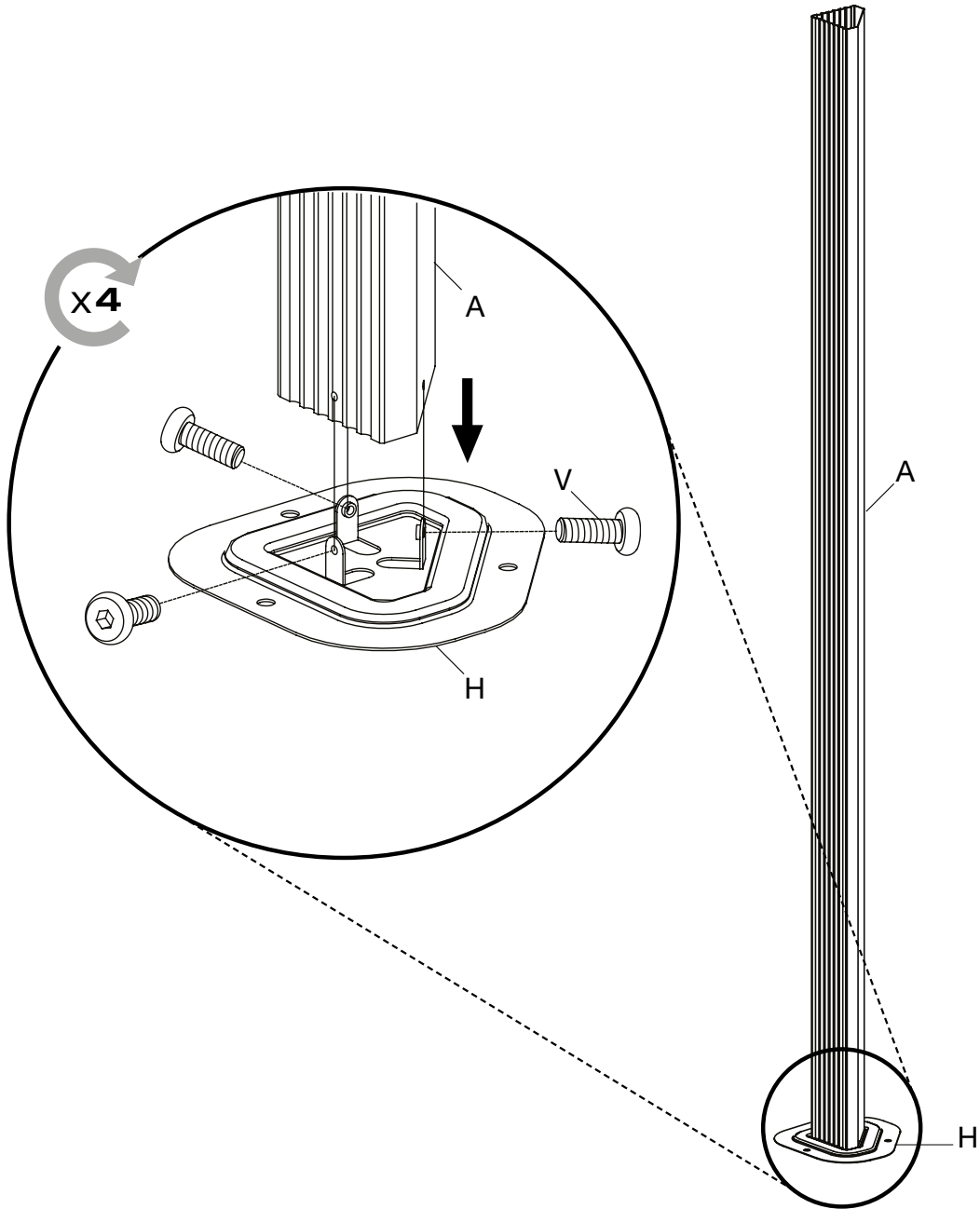

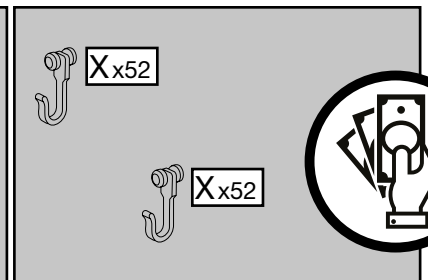
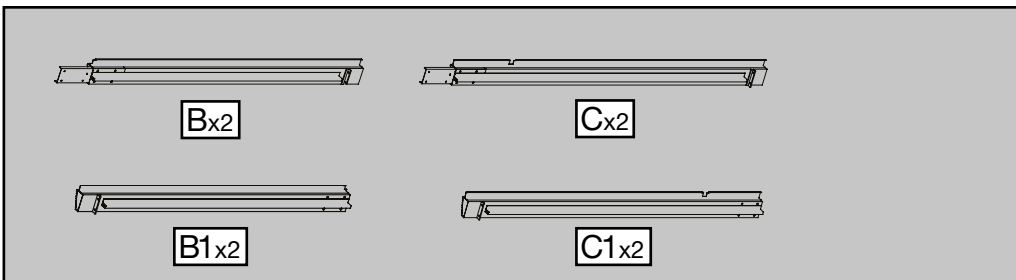
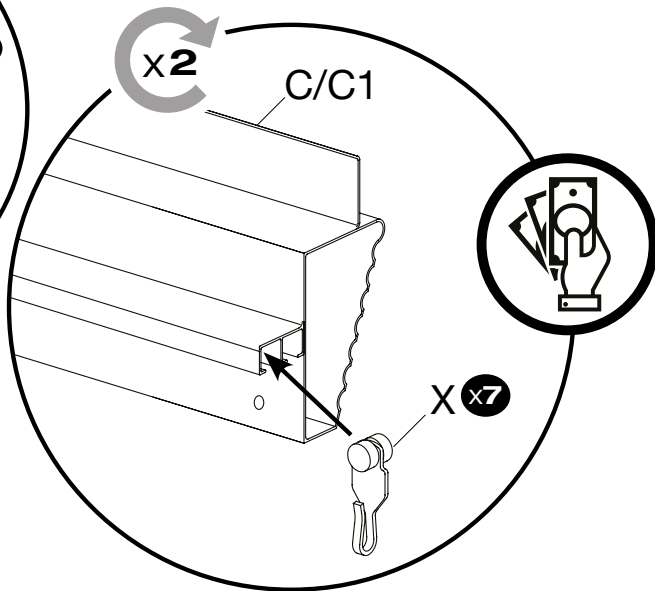
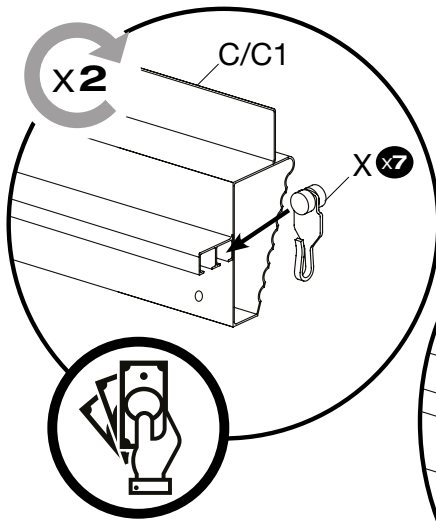
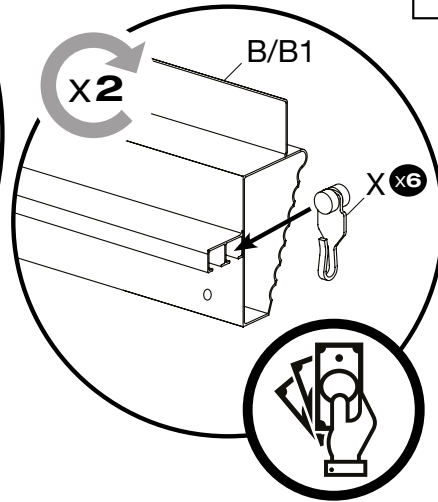
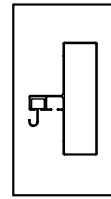
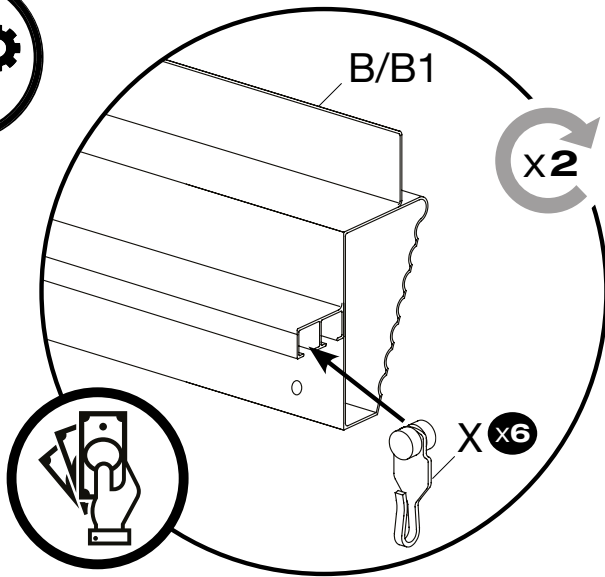
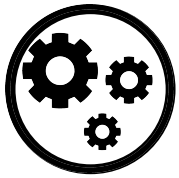

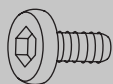
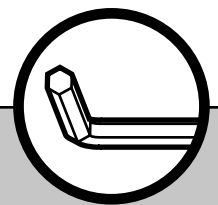
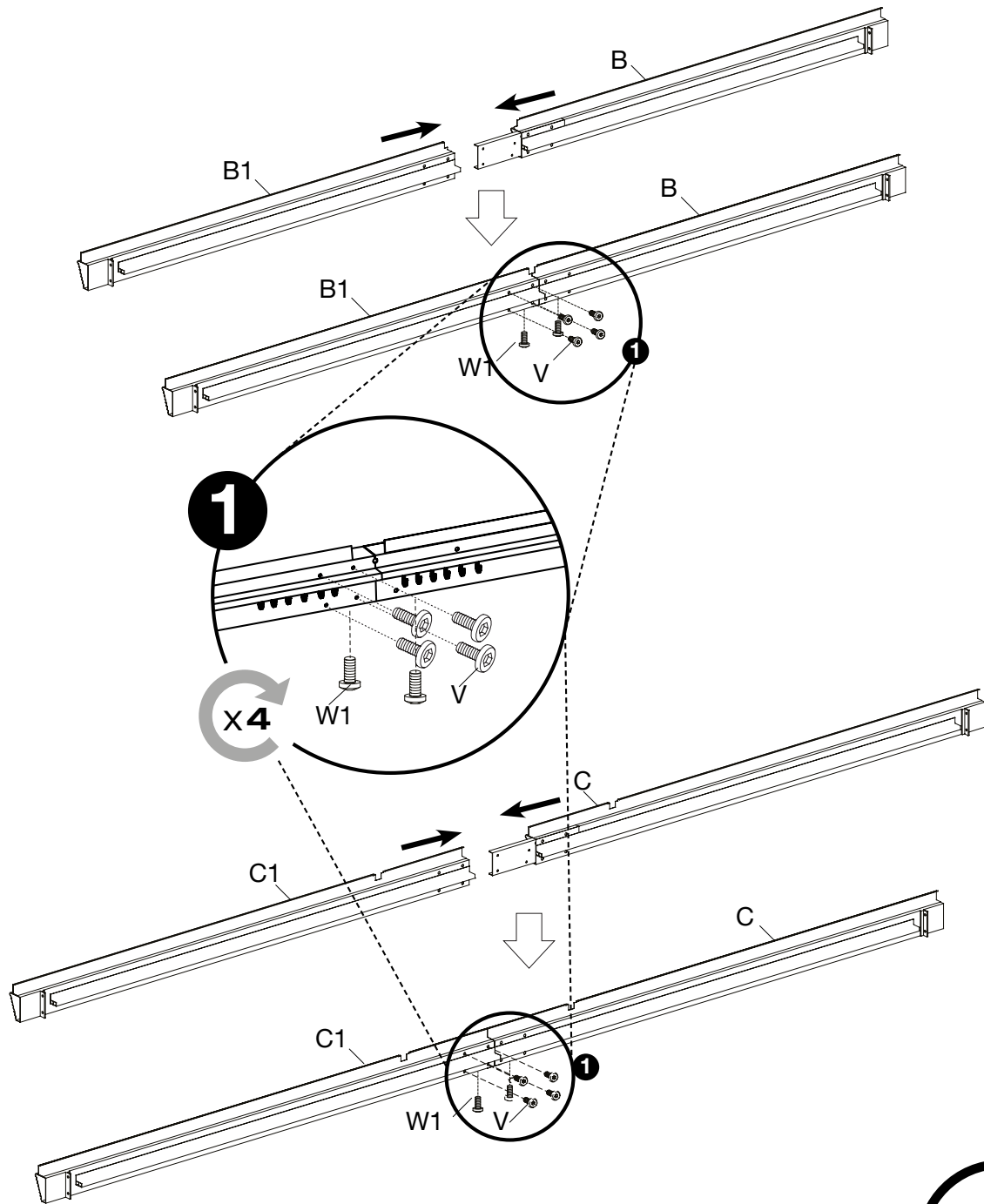

Vx16



W1x8

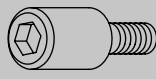
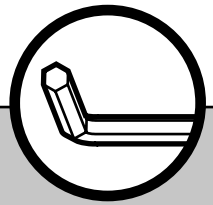
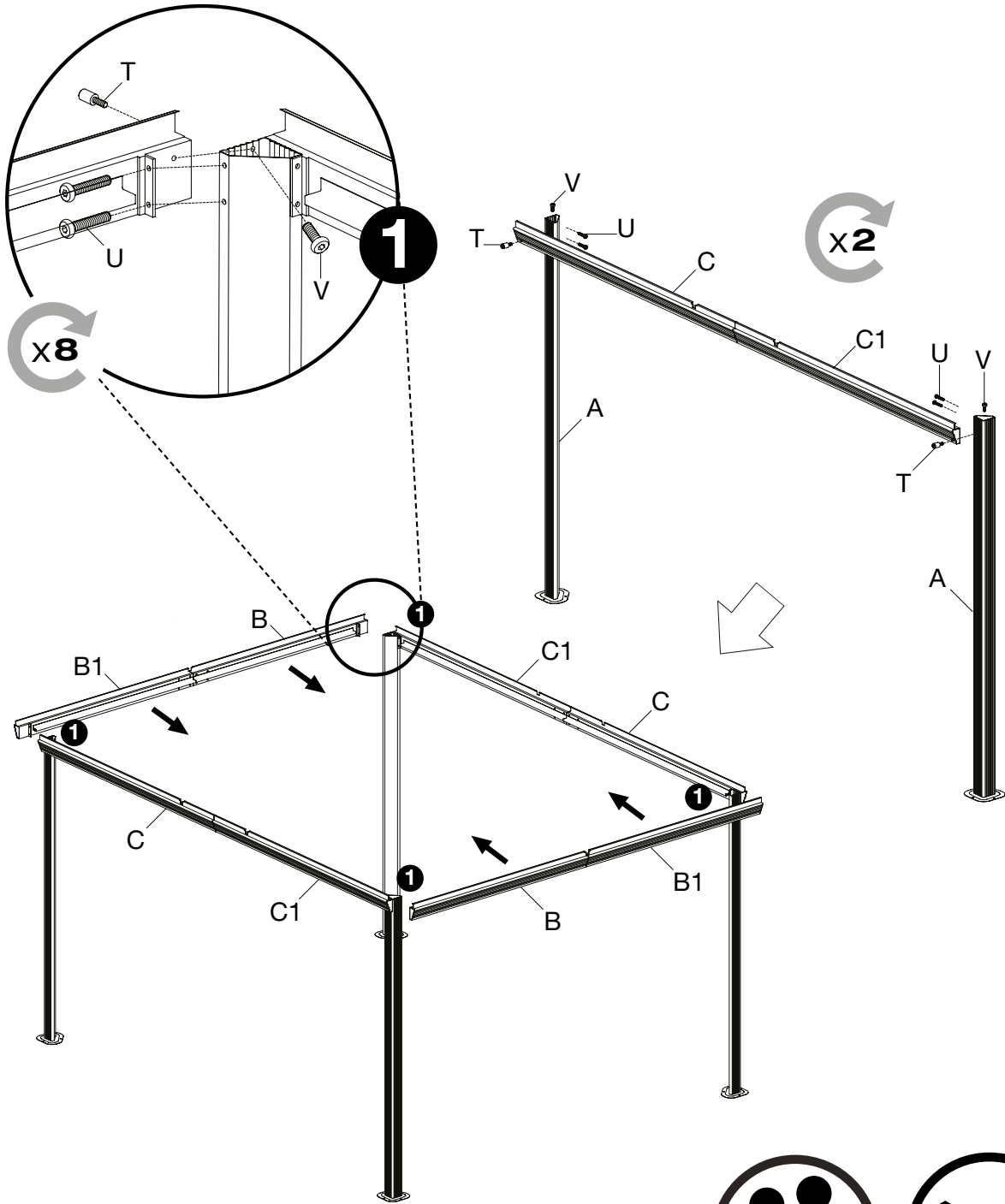

Tx8



Ux16

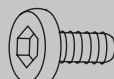

Vx8

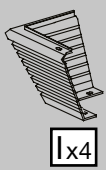
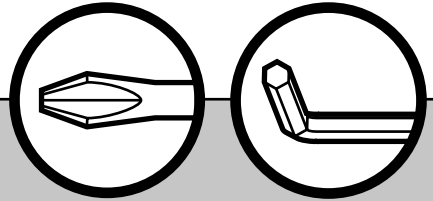
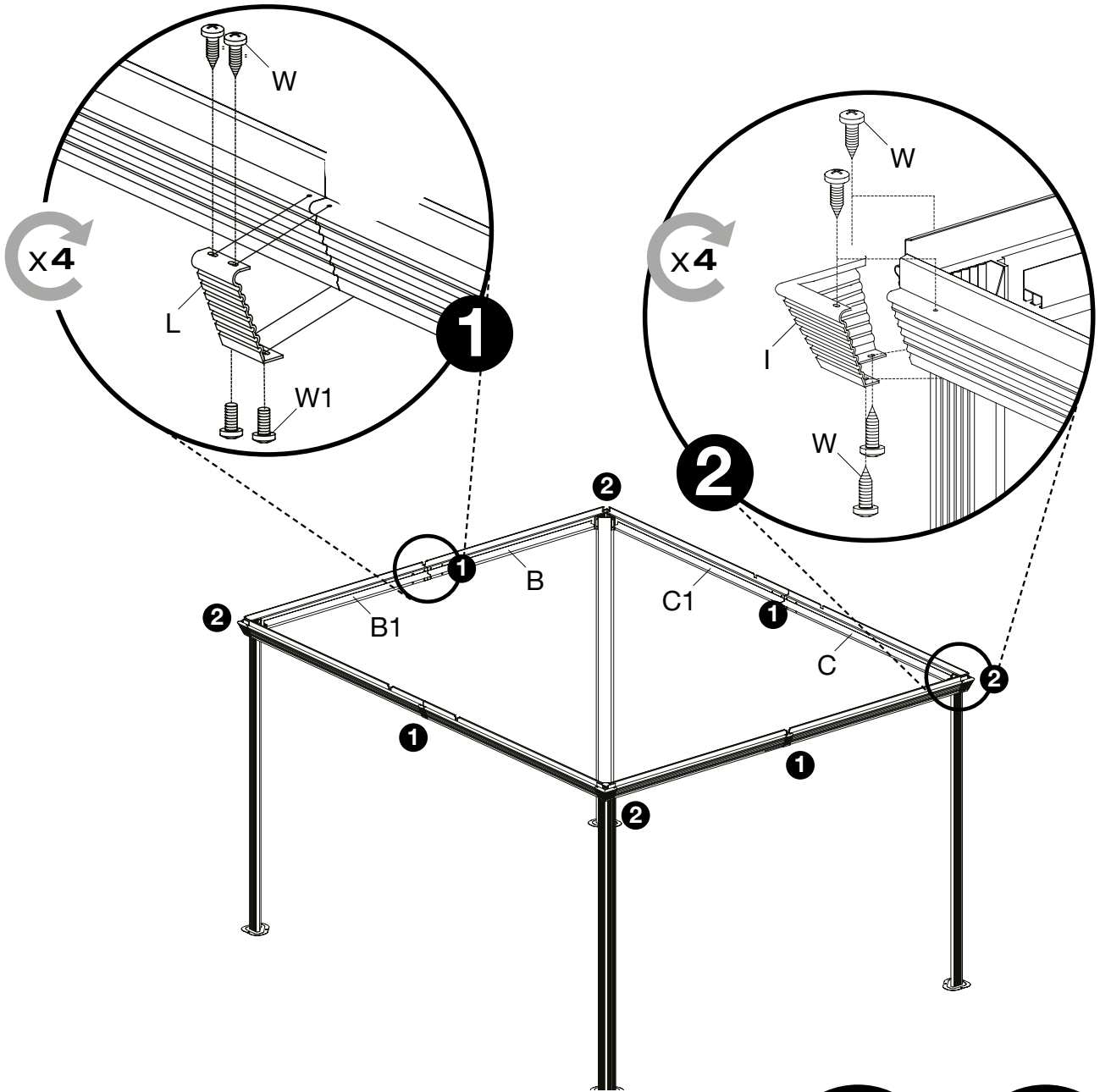

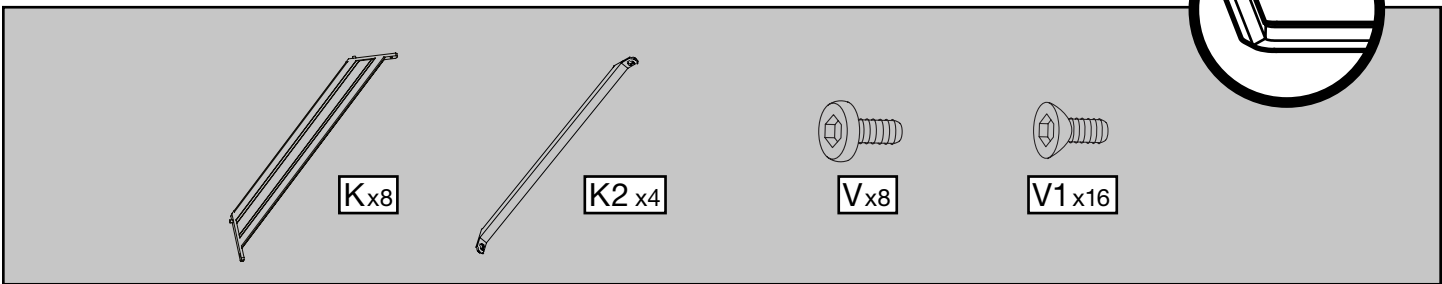
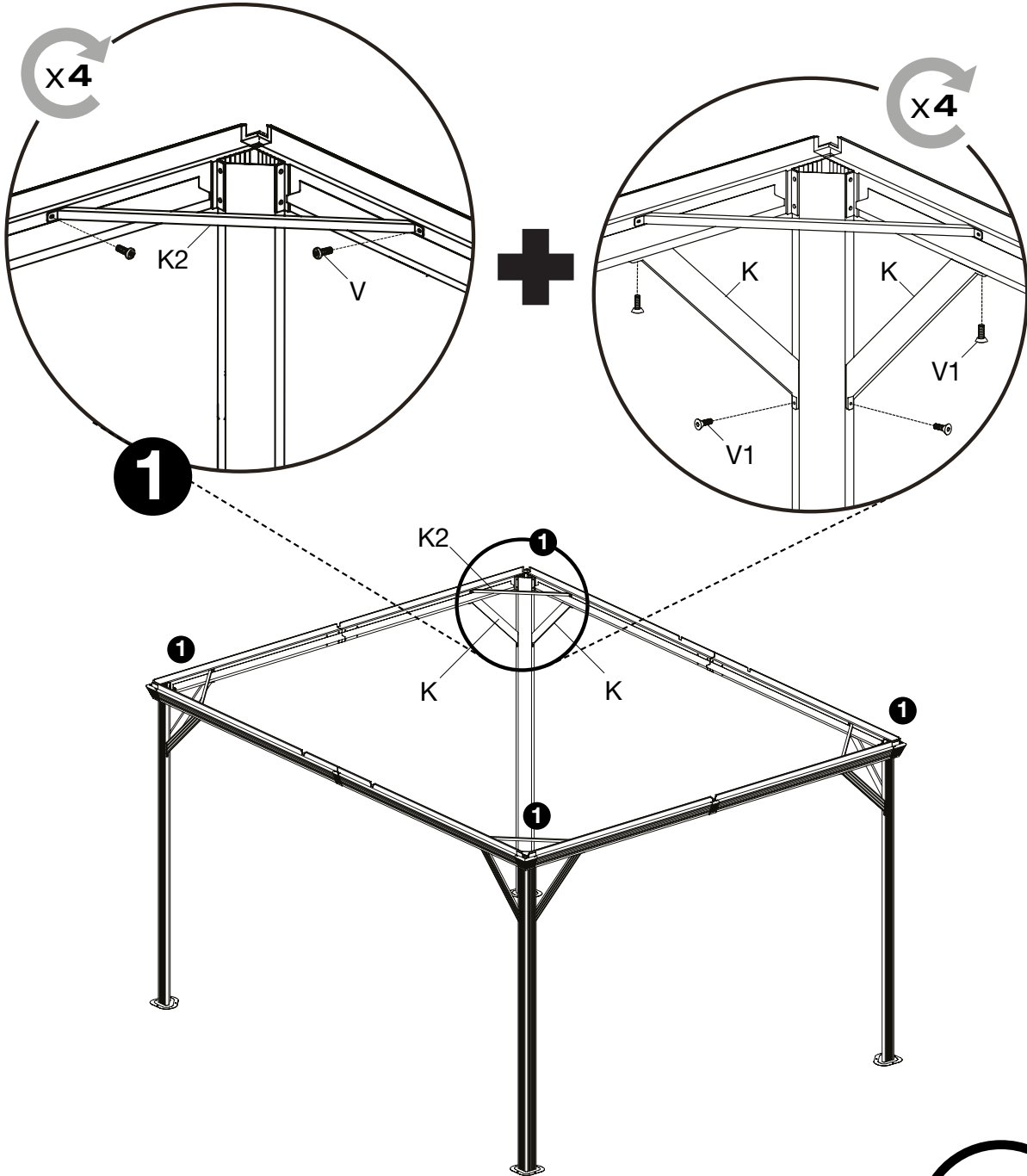

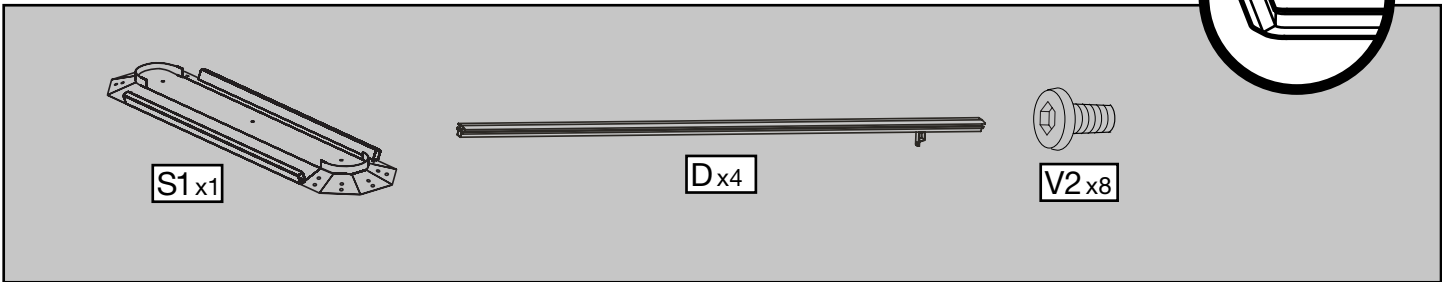
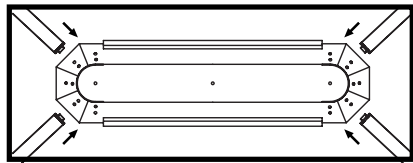
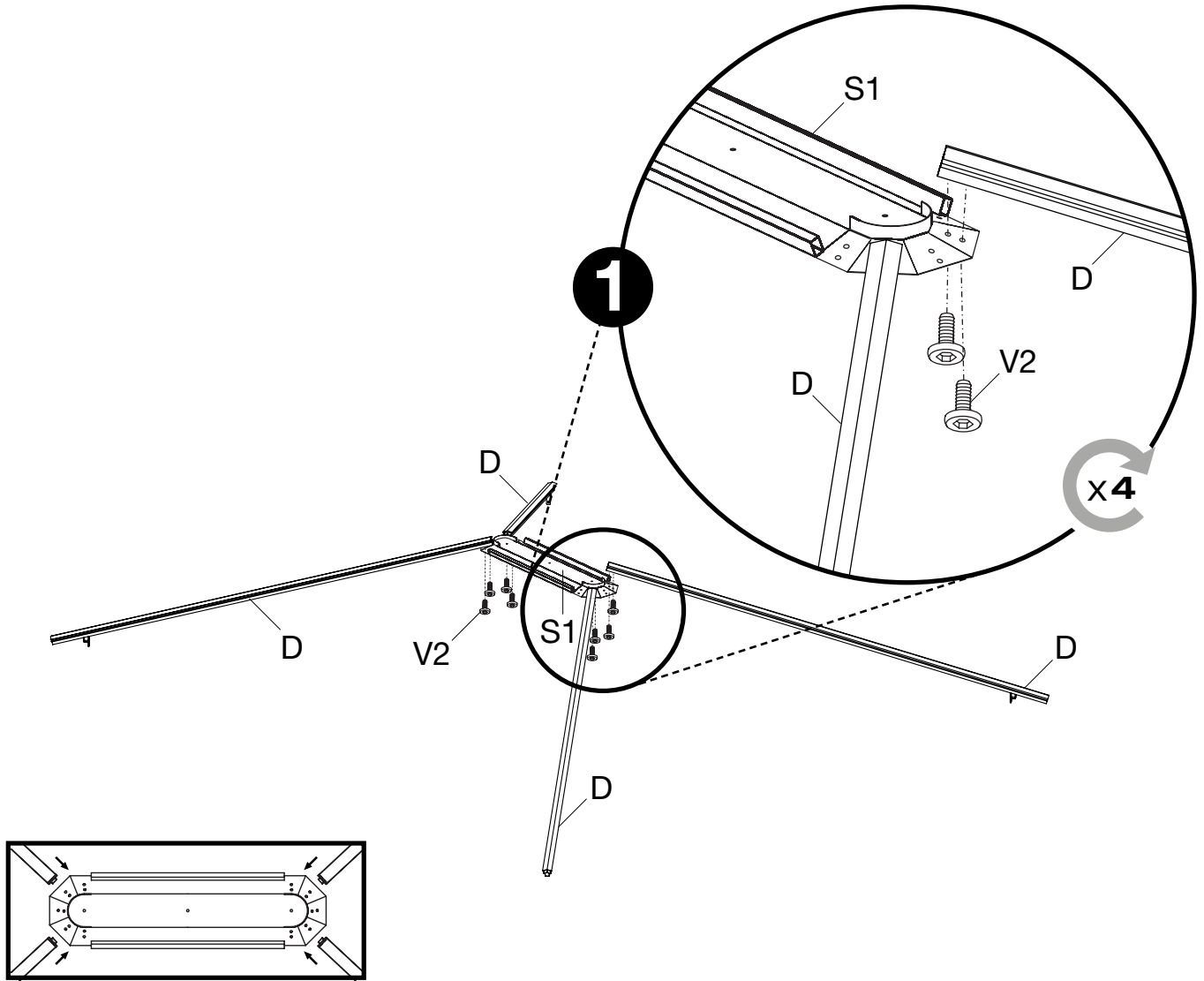

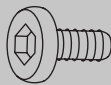
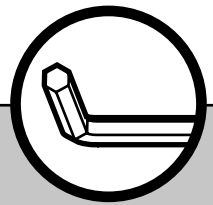
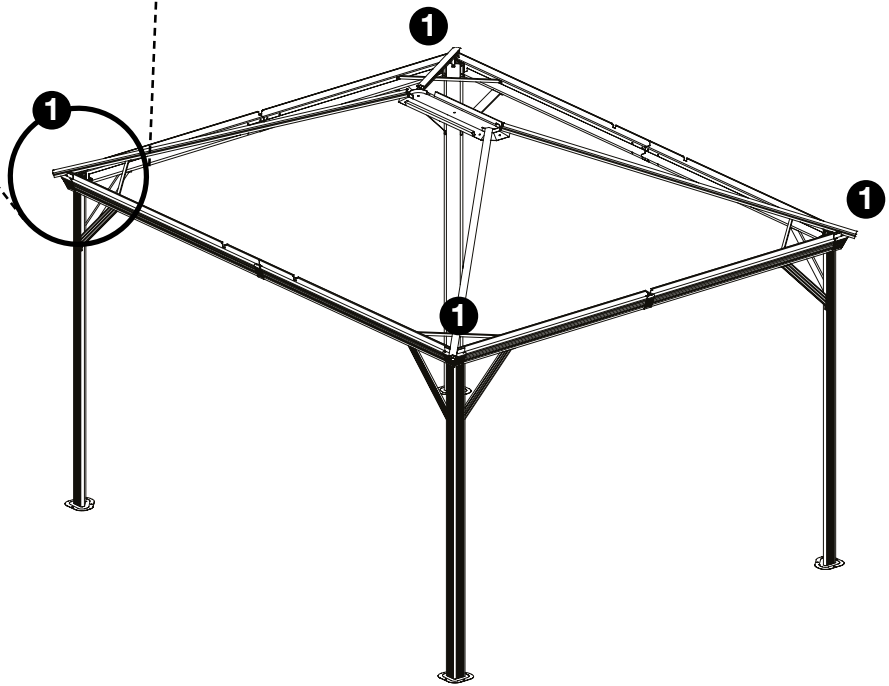
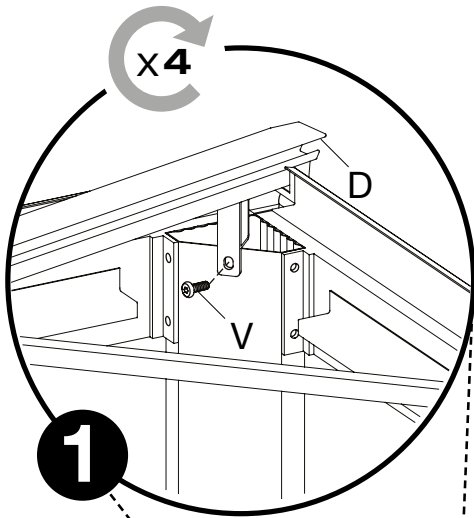

Vx4

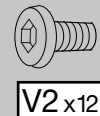
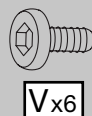
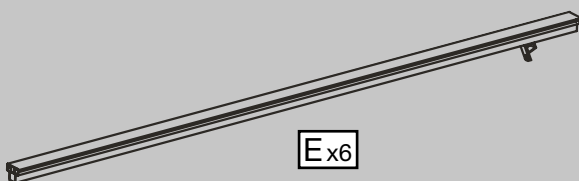
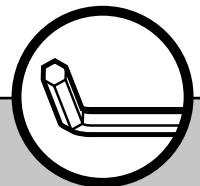
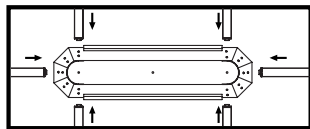
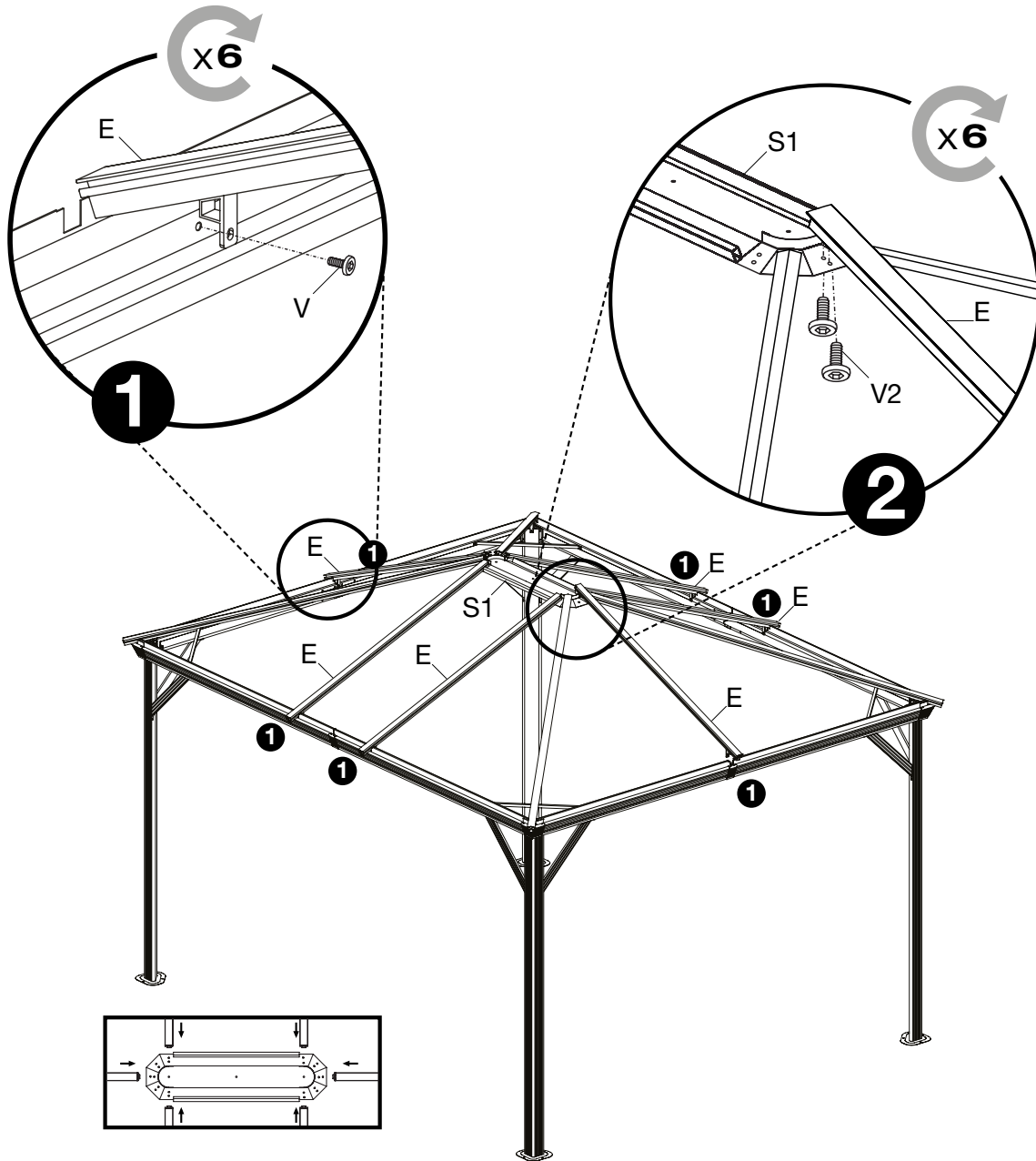

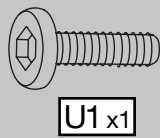
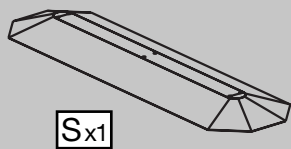
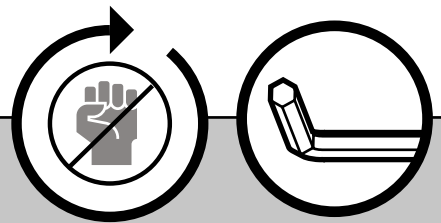
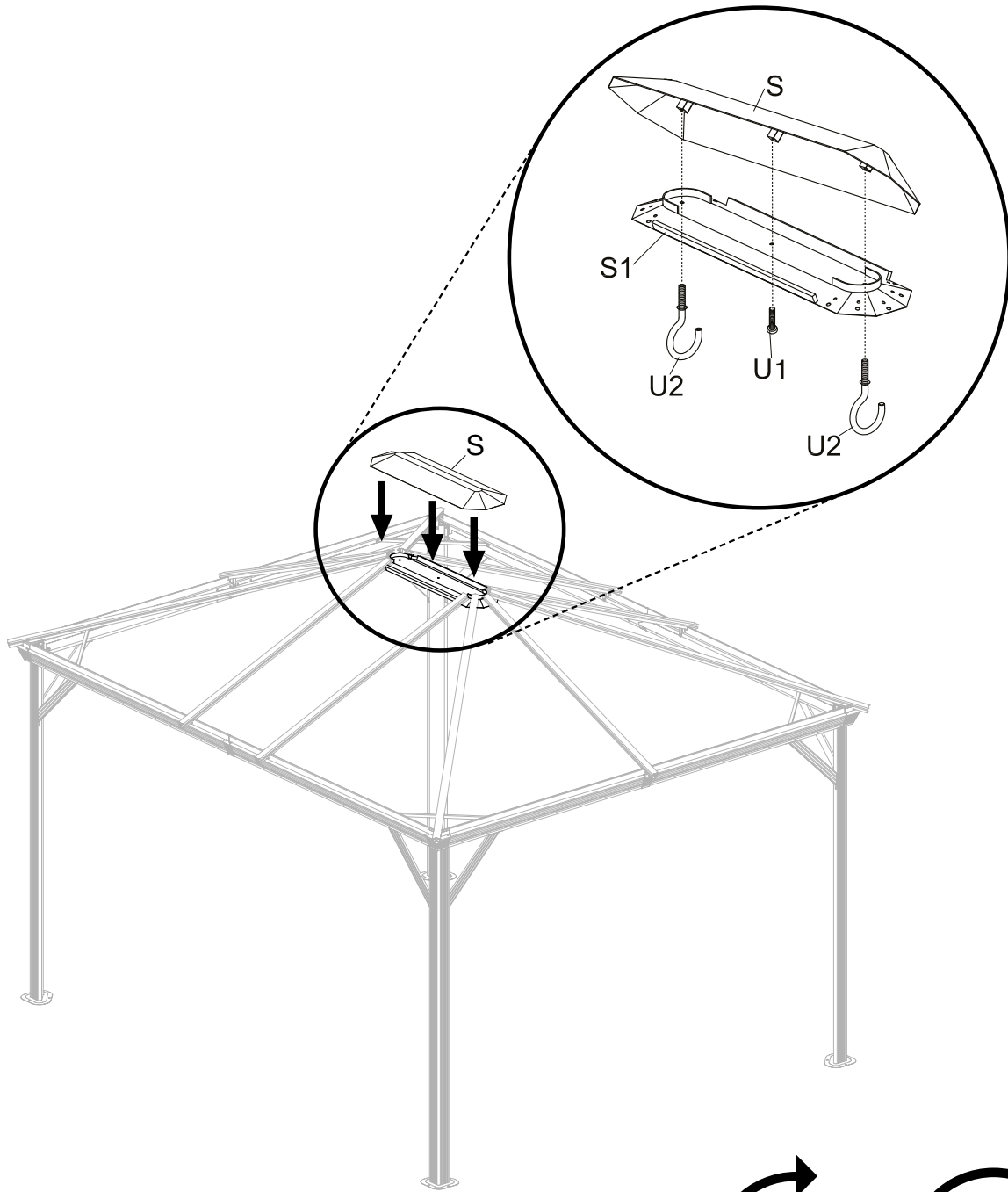

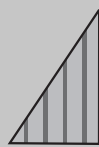
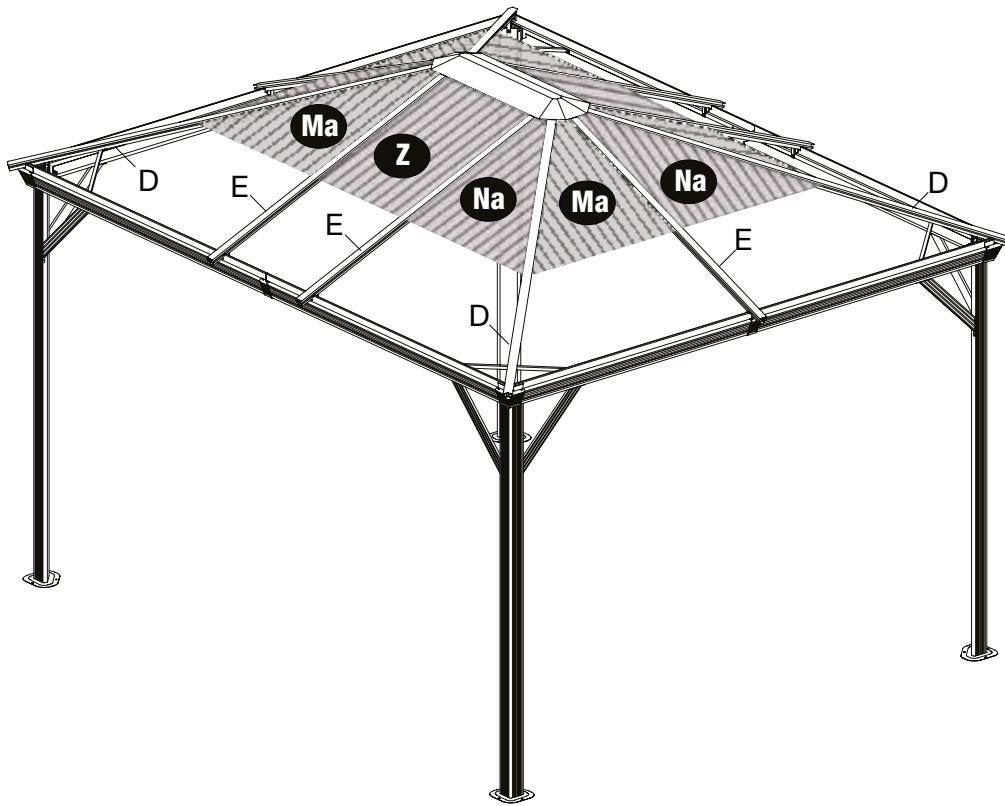
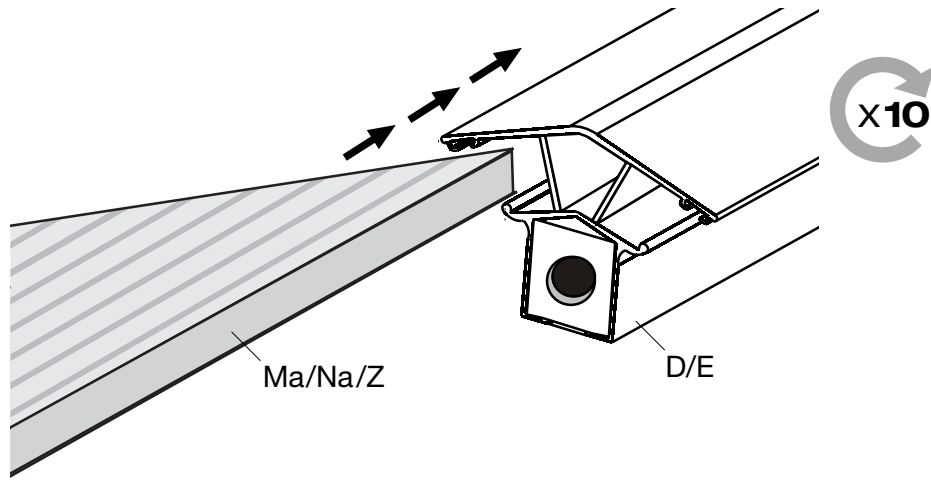

Ma x4



Z x2



Na x4

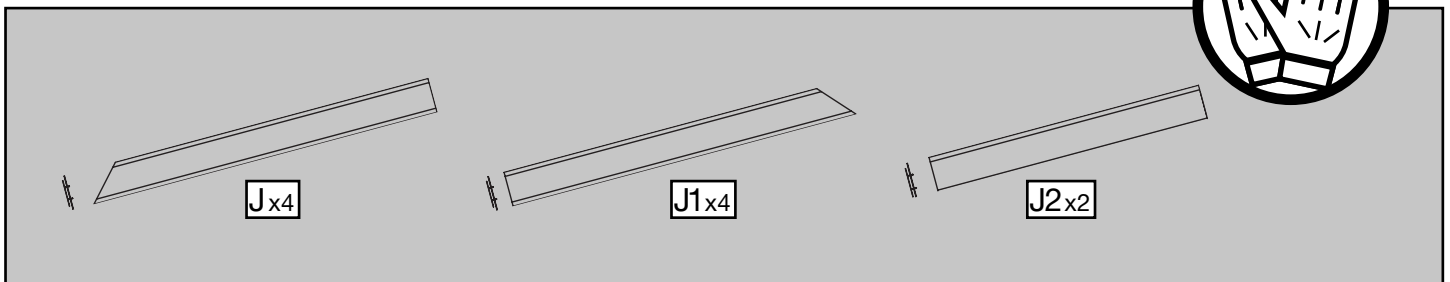
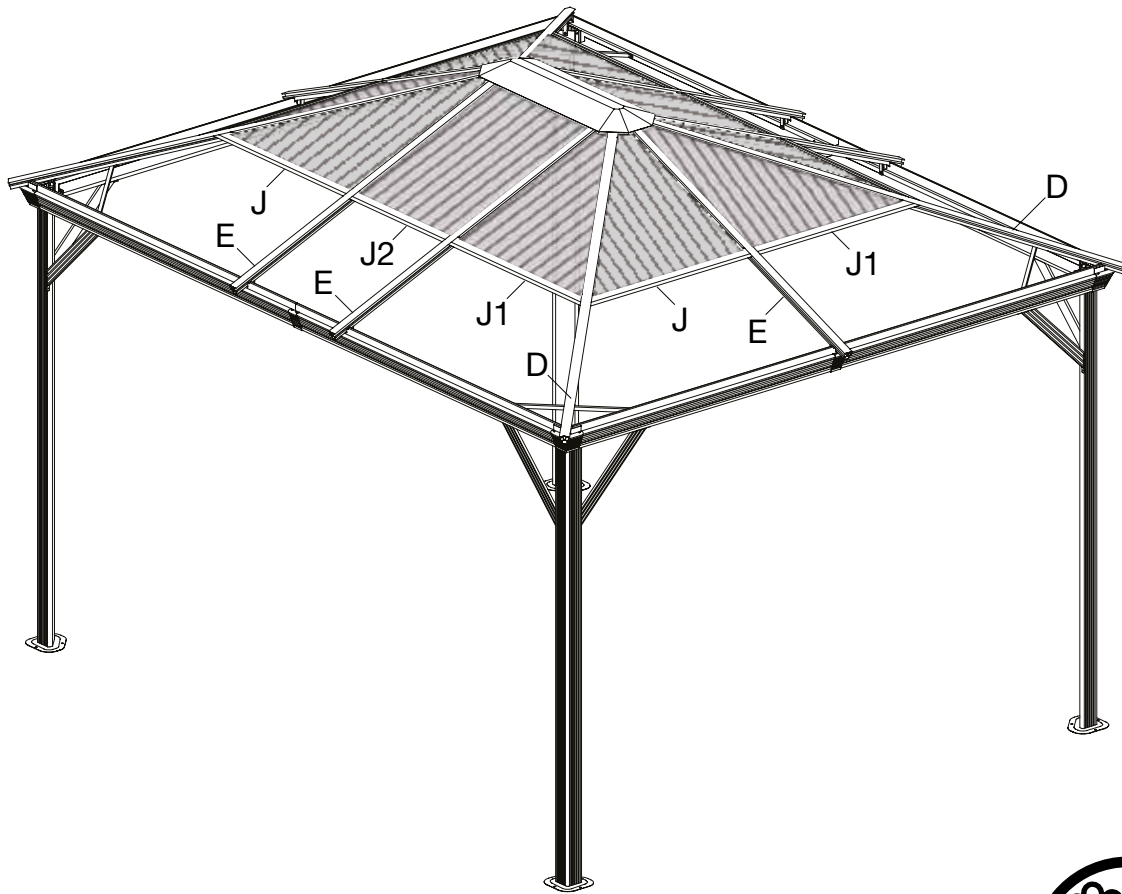
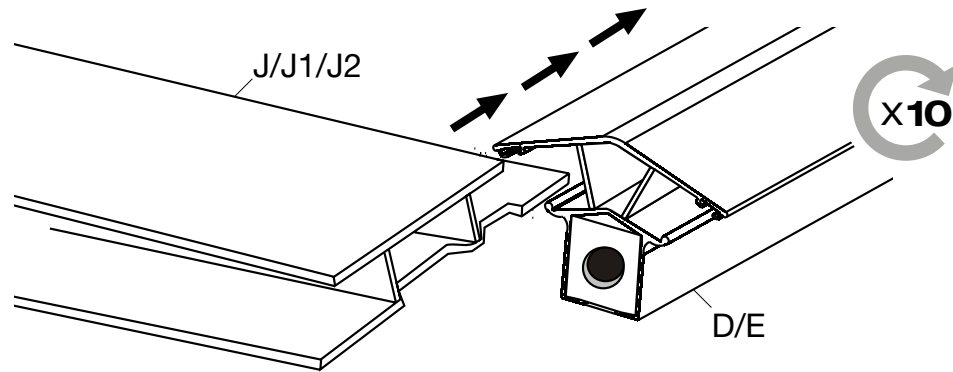

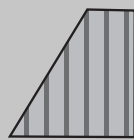
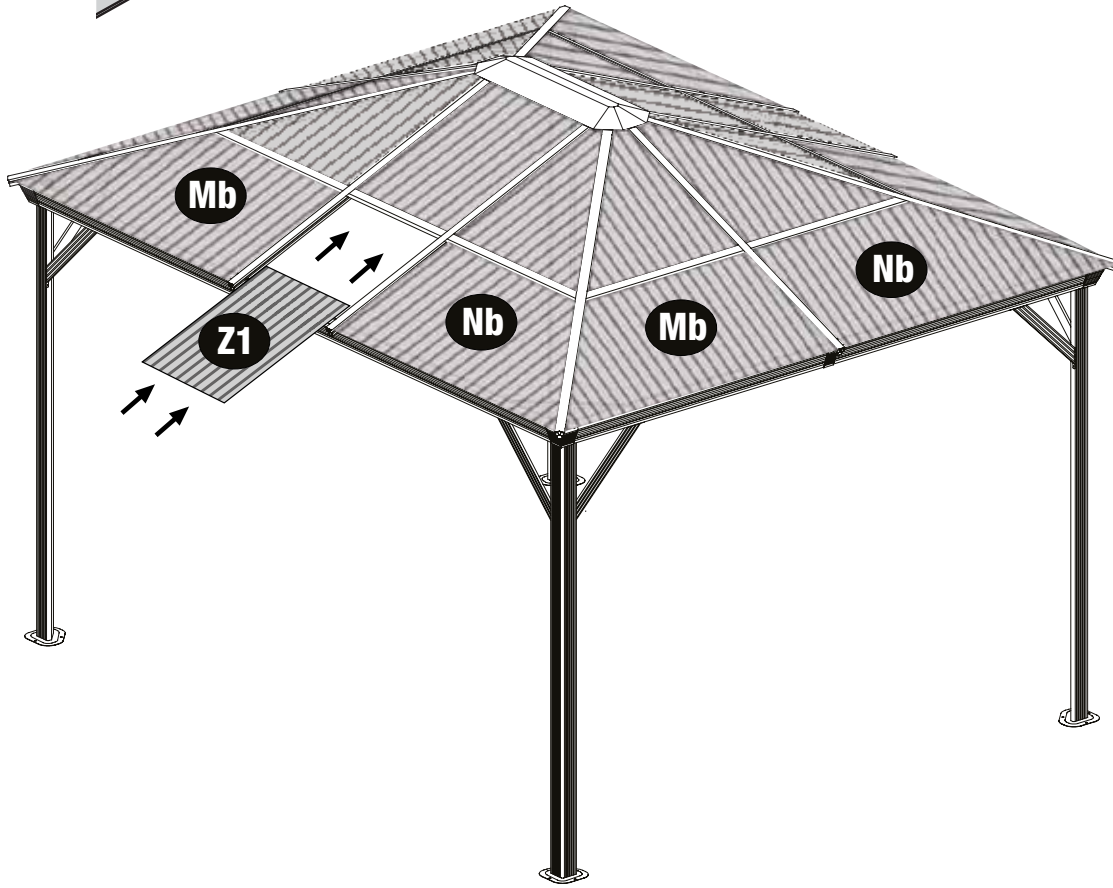
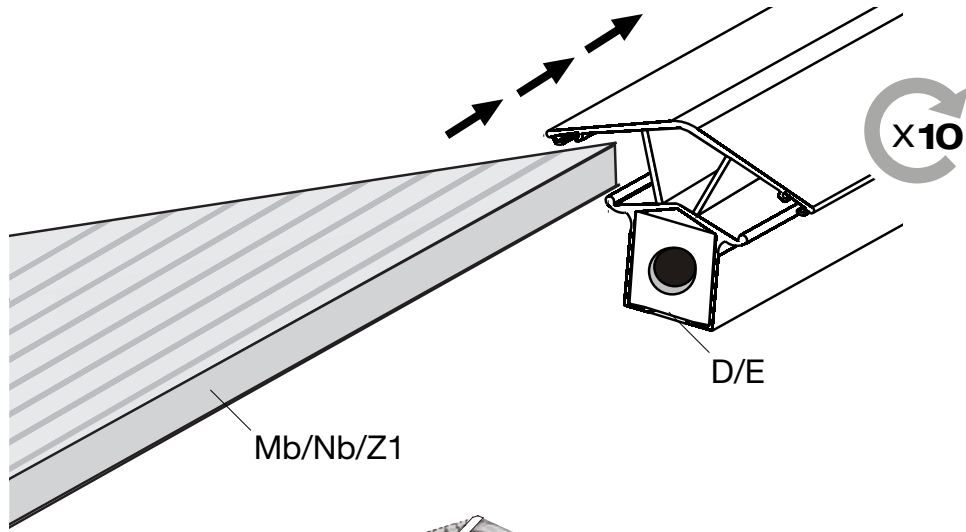

Mb x4

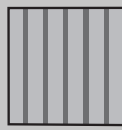

Z1 x2

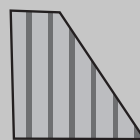

Nb x4

