

ASSEMBLY INSTRUCTIONS

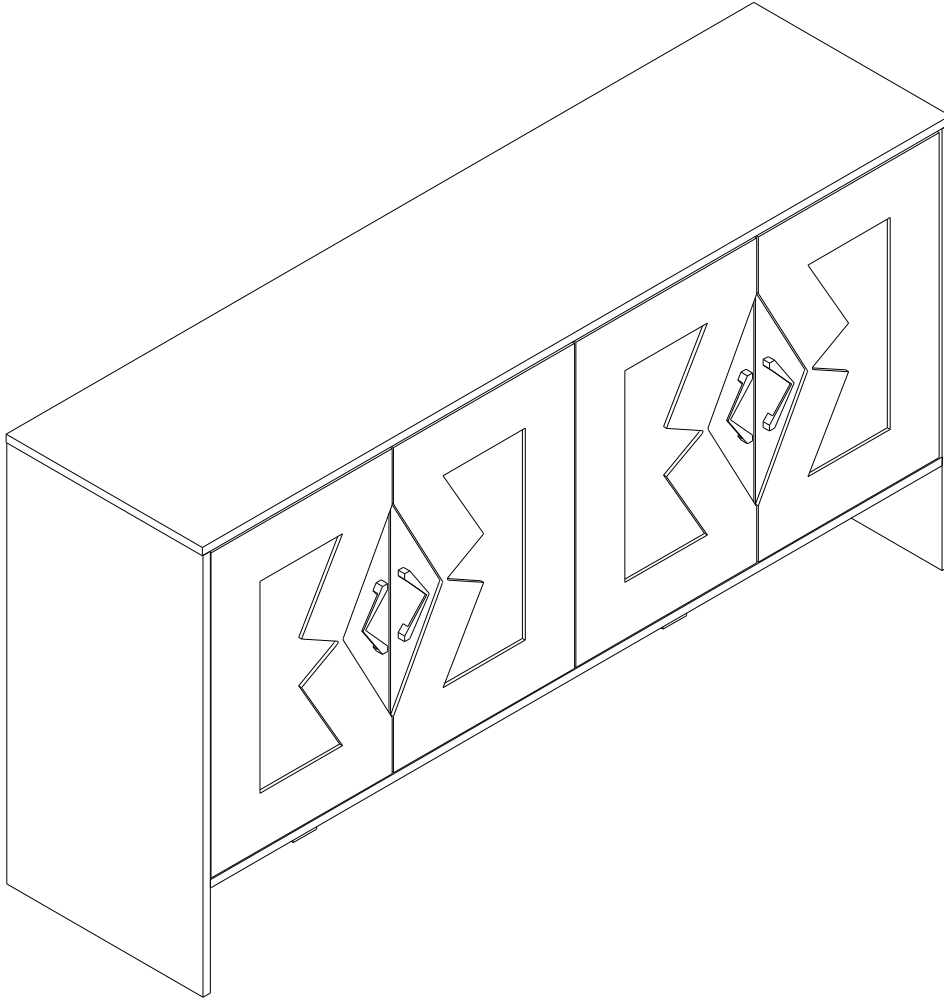

Notice:

1. Follow the installation instructions. Please confirm all accessories are preset before installation.
2. Do not fully tighten the screws during initial assembly. Fully tighten screws only once all pieces which are correctly assembled.
3. If you encounter any problems during installation, please contact our customer service.
4. Please unbox the item from the side with an open-label and put a carpet on the floor to avoid scratching it.

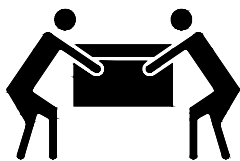

Recommended installers:2

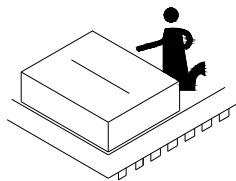

Put a carpet on the floor
before unpacking

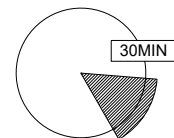

Estimate installation time:
30minutes





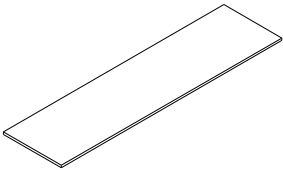
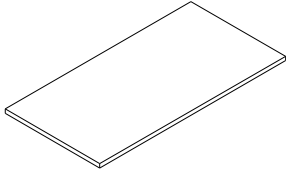
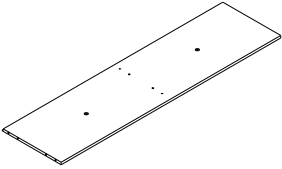
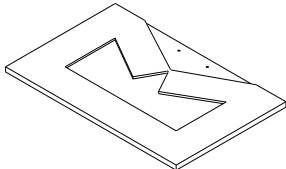
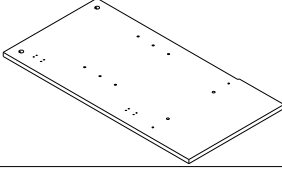
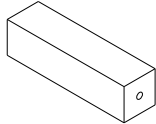
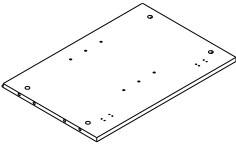
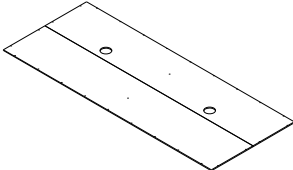
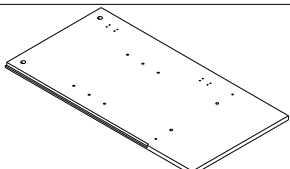
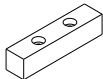





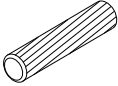

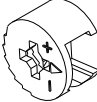

ASSEMBLY INSTRUCTIONS

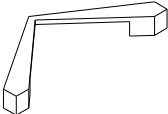
PART LIST

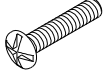
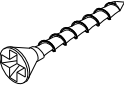
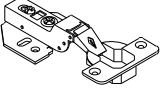
Item no.	Reference Image	Qty		Item no.	Reference Image	Qty
Ⓐ		X1		Ⓕ		X2
Ⓑ		X1		Ⓖ		X4
Ⓒ		X1		Ⓖ		X2
Ⓓ		X1		Ⓖ		X1
Ⓔ		X1		Ⓖ		X4

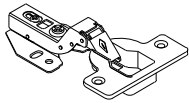
ASSEMBLY INSTRUCTIONS

HARDWARE LIST

Item no.	Reference Image	Qty	Item no.	Reference Image	Qty
1	 Ø8*30mm	X12+1	9		X8
2		X12+1	10	 Ø1/4"*1"-1/4"	X2
3		X12+1	11		X2
4		X4	12		X2
5		X8	13	 Ø4*25mm	X4
6		X4	14	 Ø3*15mm	X26+2
7		X4	15		X1
8	 Ø3*12mm	X48+4	16		X2

ASSEMBLY INSTRUCTIONS

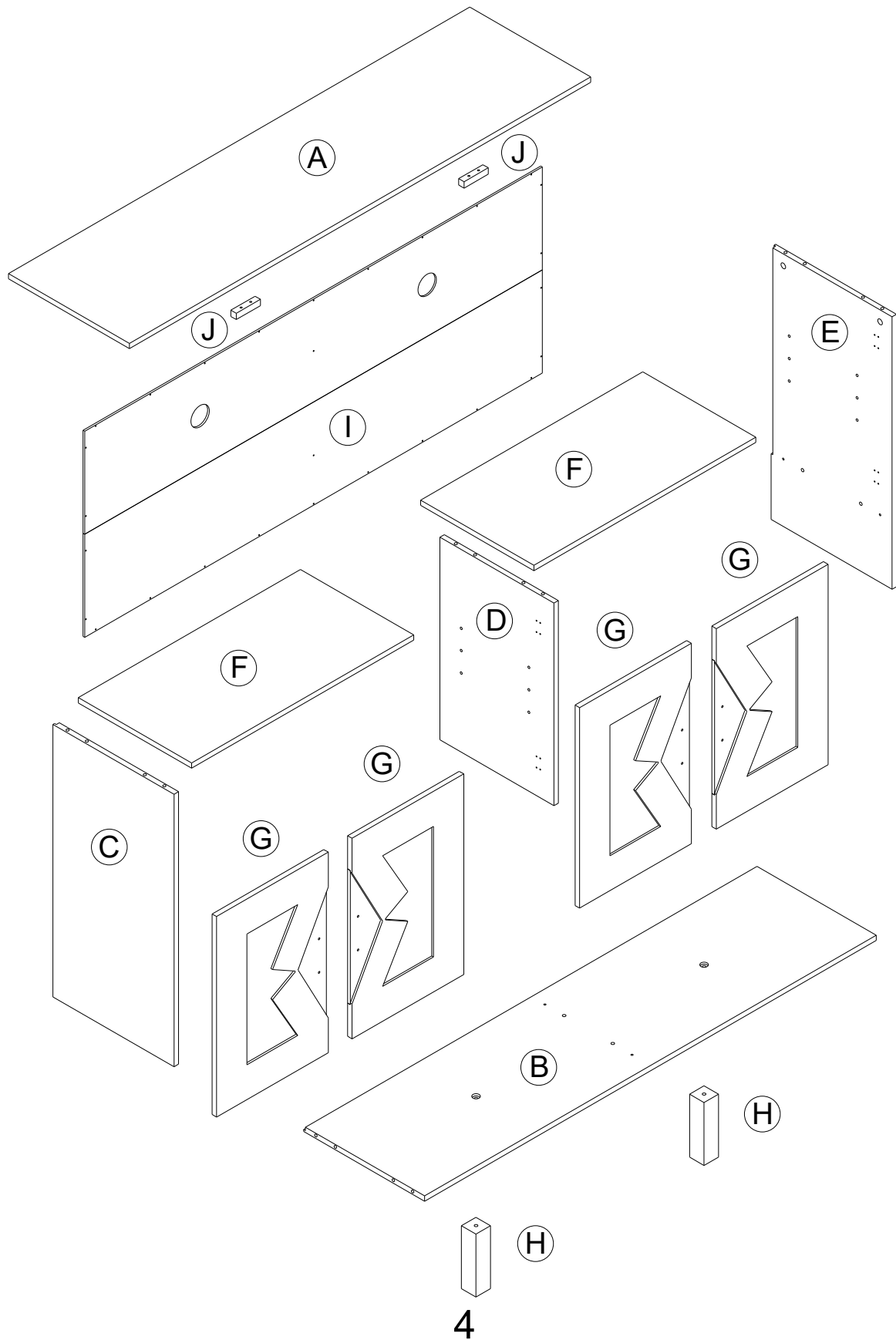

ASSEMBLY INSTRUCTIONS

1

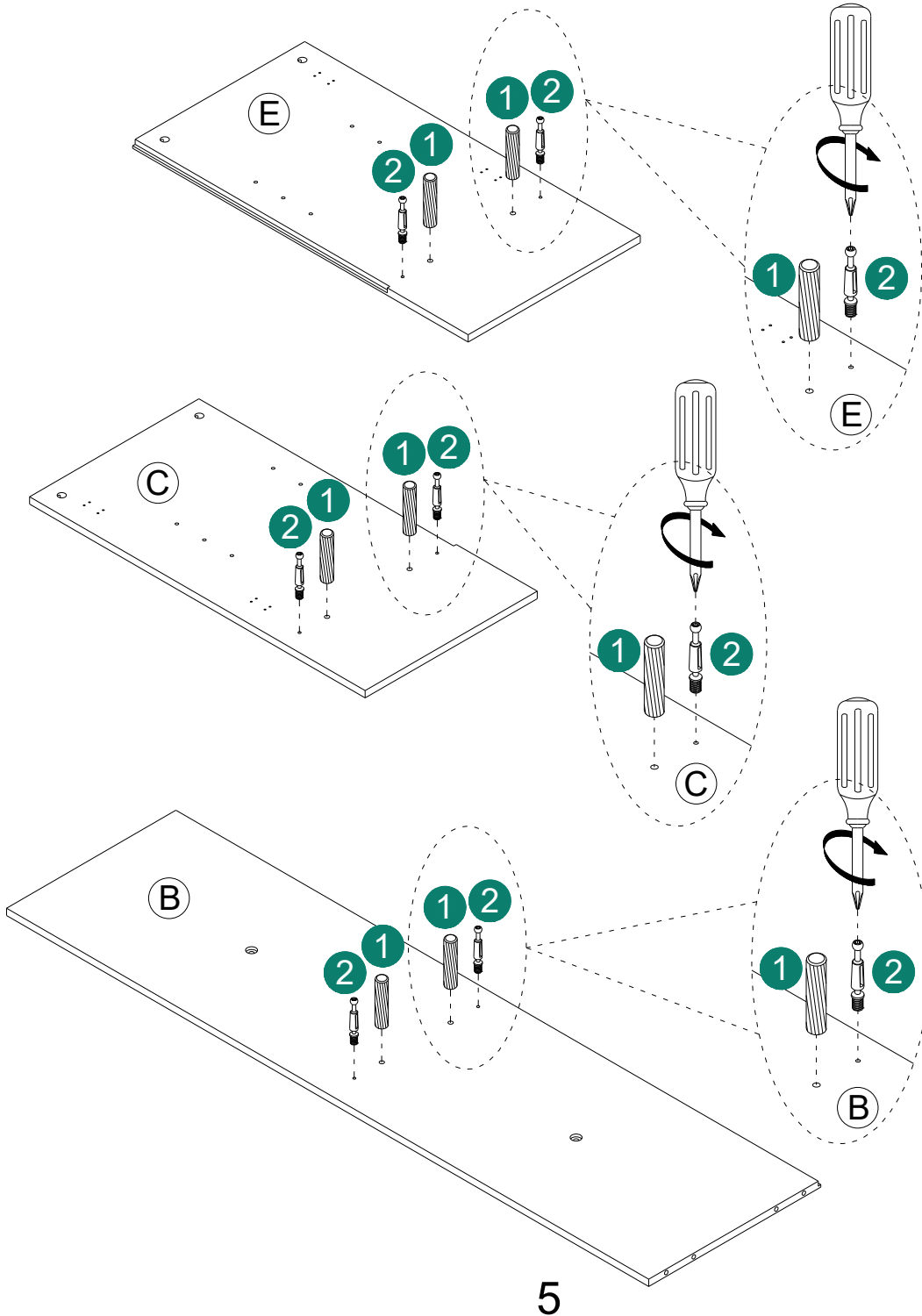
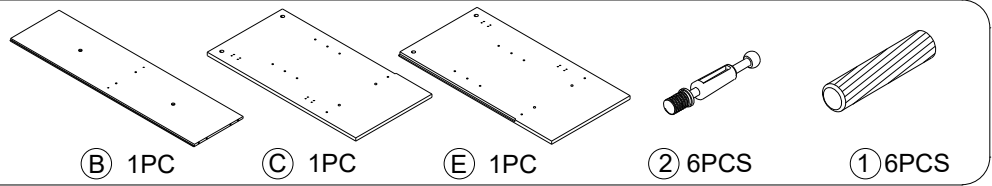

ASSEMBLY INSTRUCTIONS

2

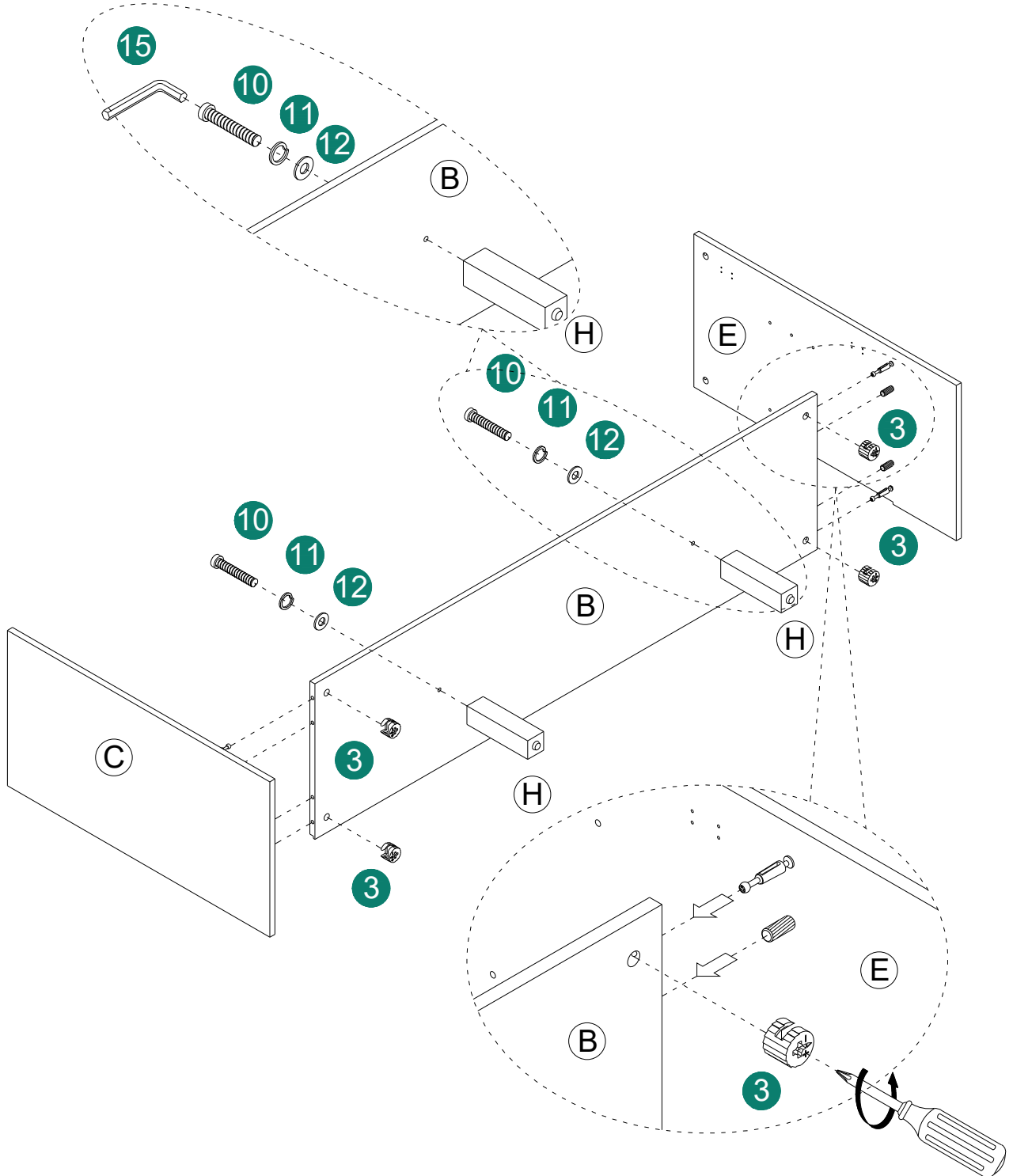
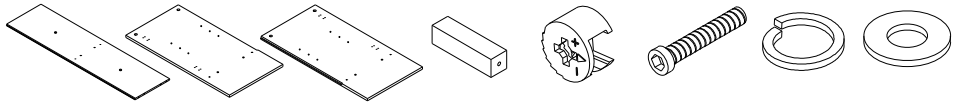

6

ASSEMBLY INSTRUCTIONS

3

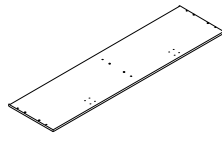

(A) 1PC

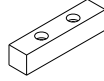

(8) 4PCS



(9) 8PCS



(2) 6PCS

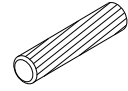

(1) 6PCS

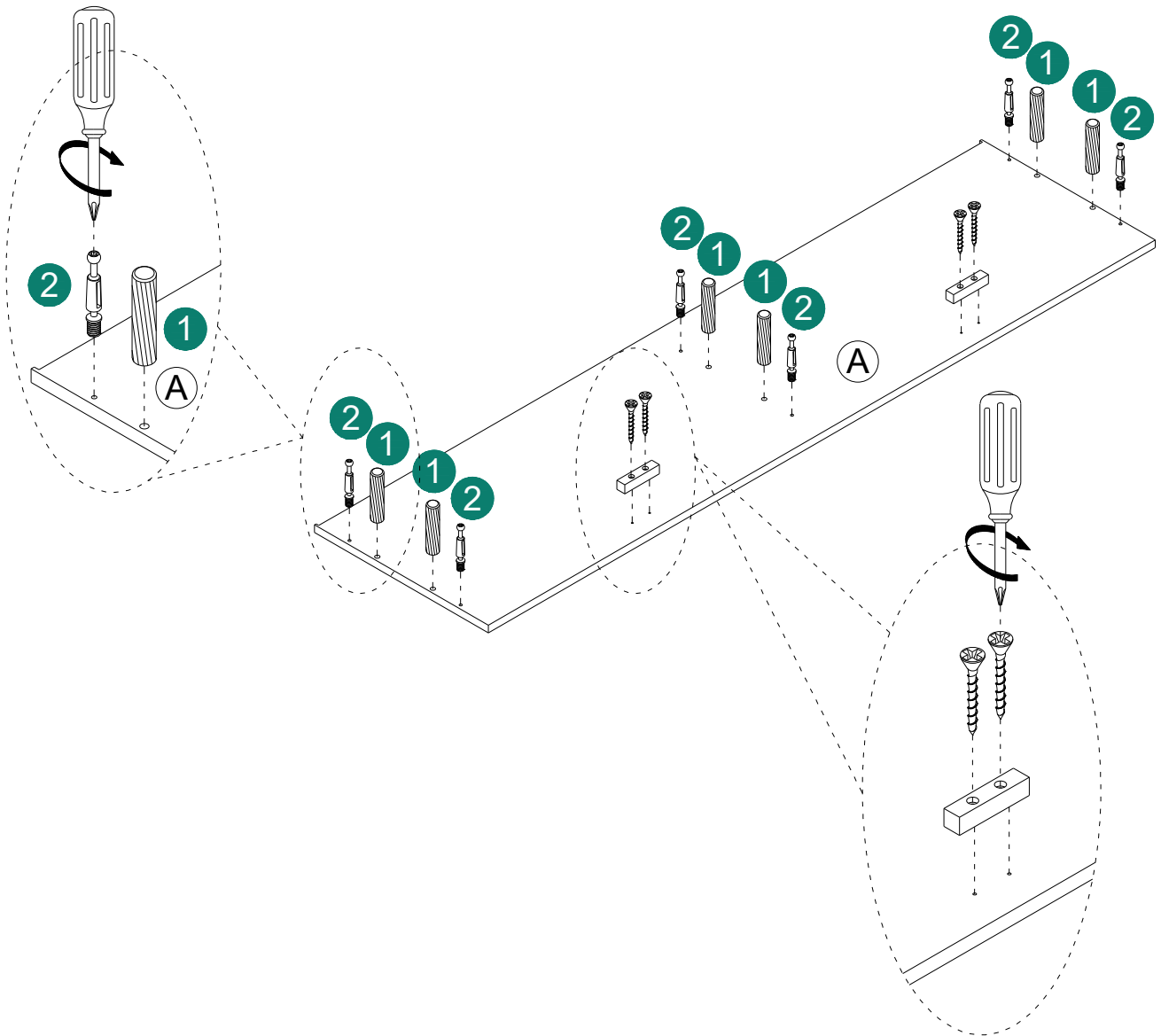

ASSEMBLY INSTRUCTIONS

4

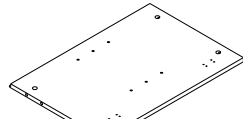

Ⓓ 1PC

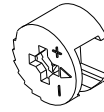

③ 2PCS

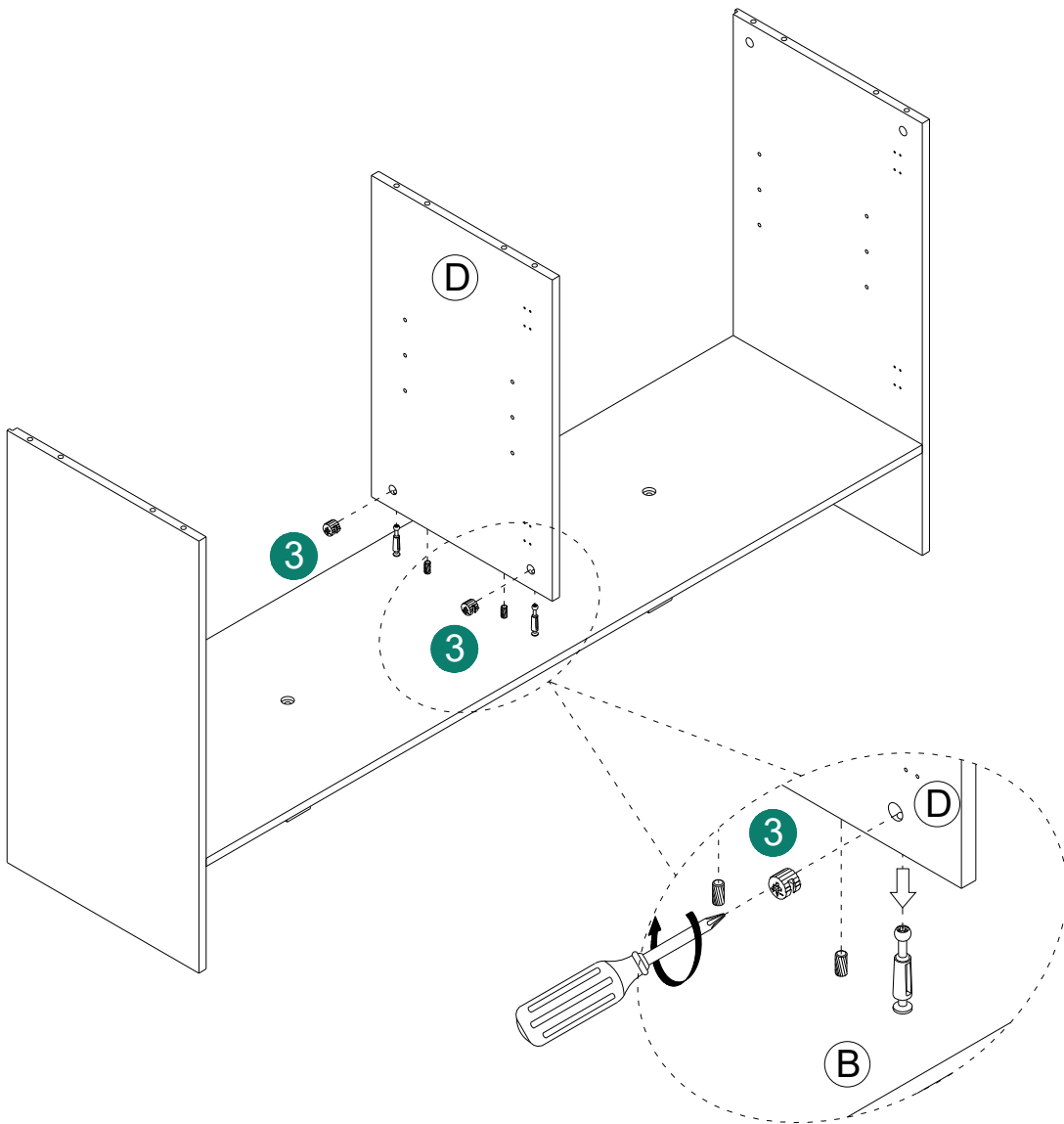

ASSEMBLY INSTRUCTIONS

5

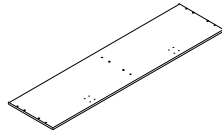

(A) 1PC

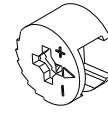

(3) 6PCS

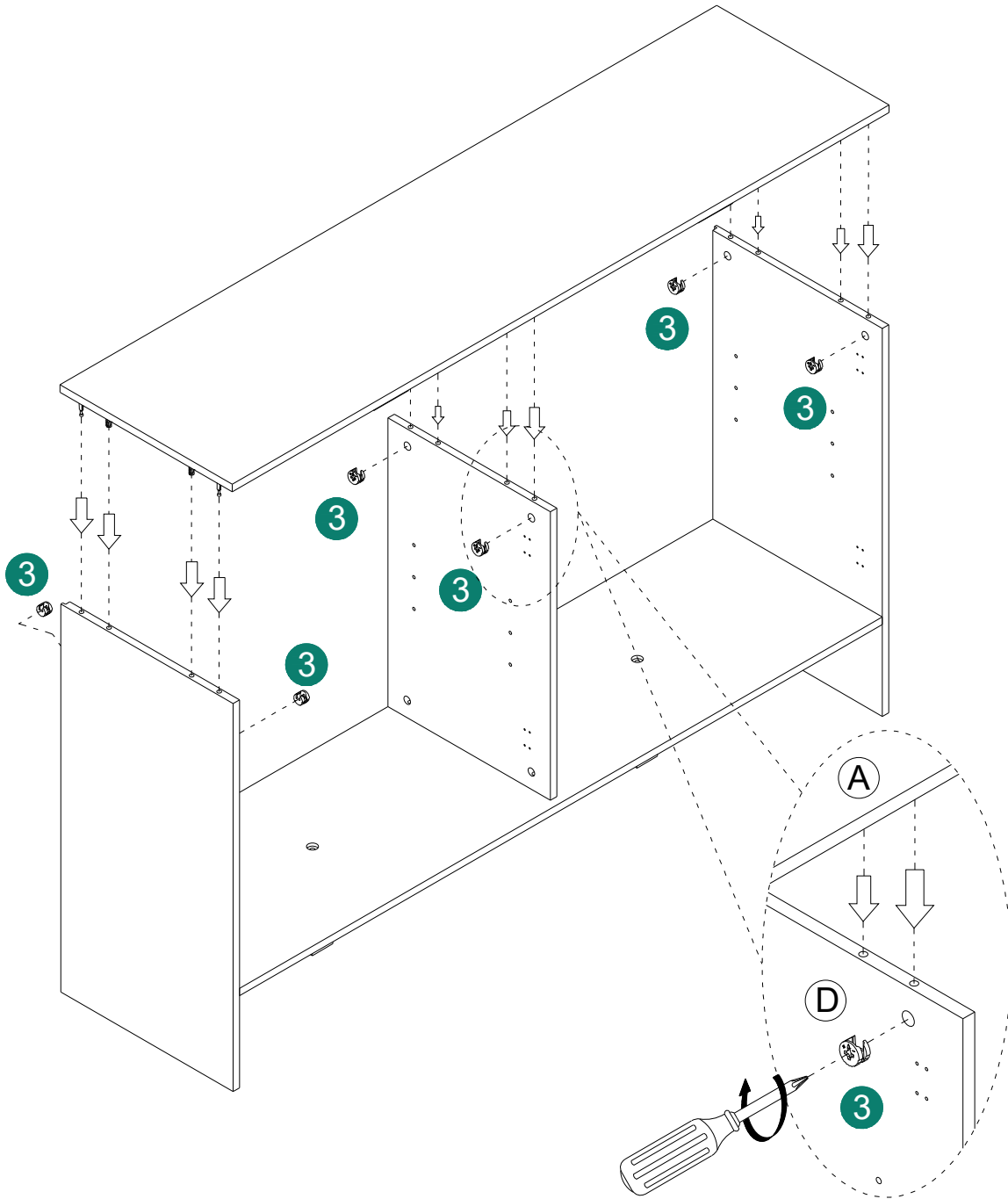

ASSEMBLY INSTRUCTIONS

6

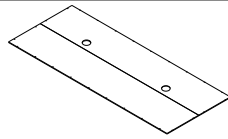

I 1PC



14 26PCS

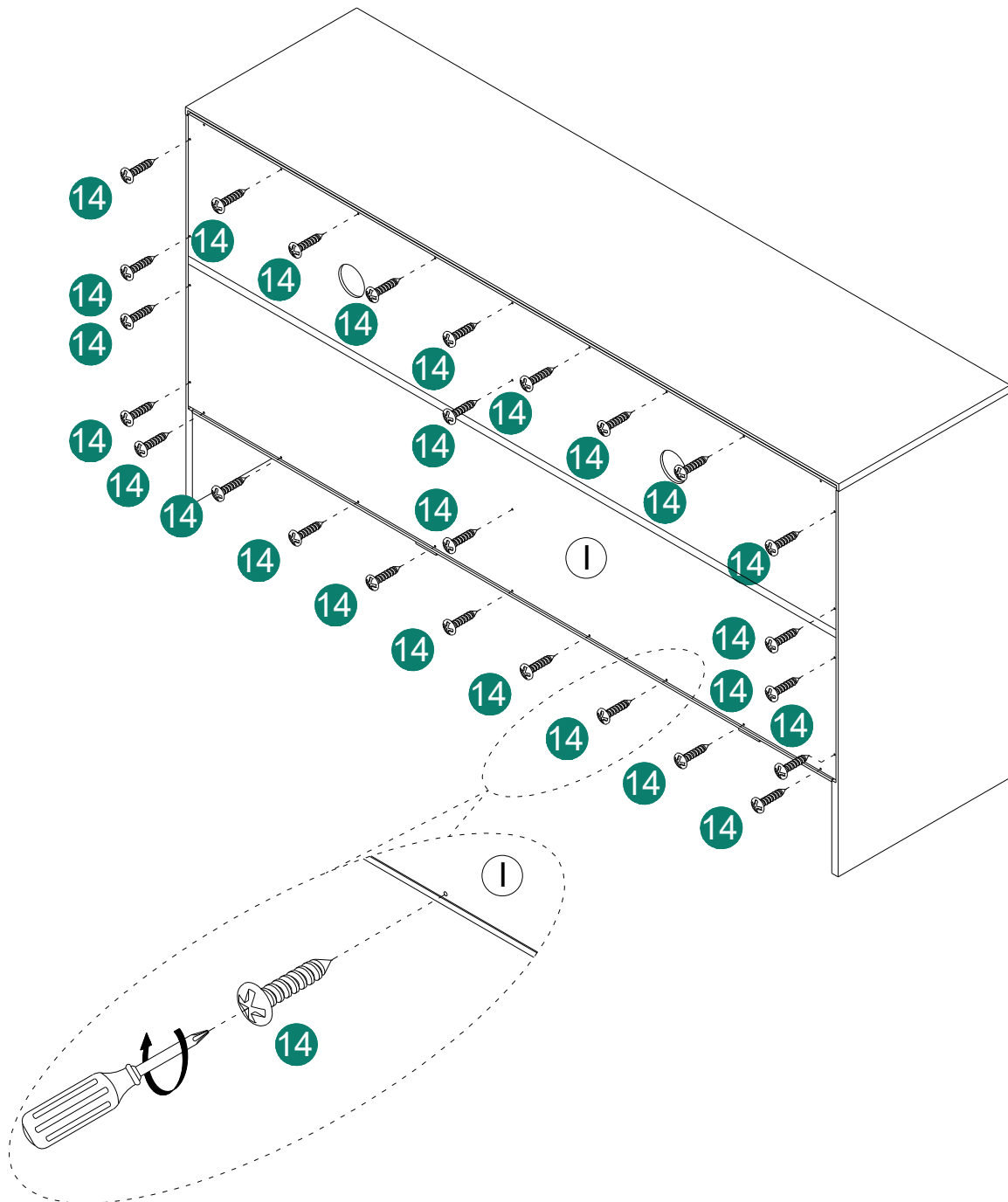

ASSEMBLY INSTRUCTIONS

7

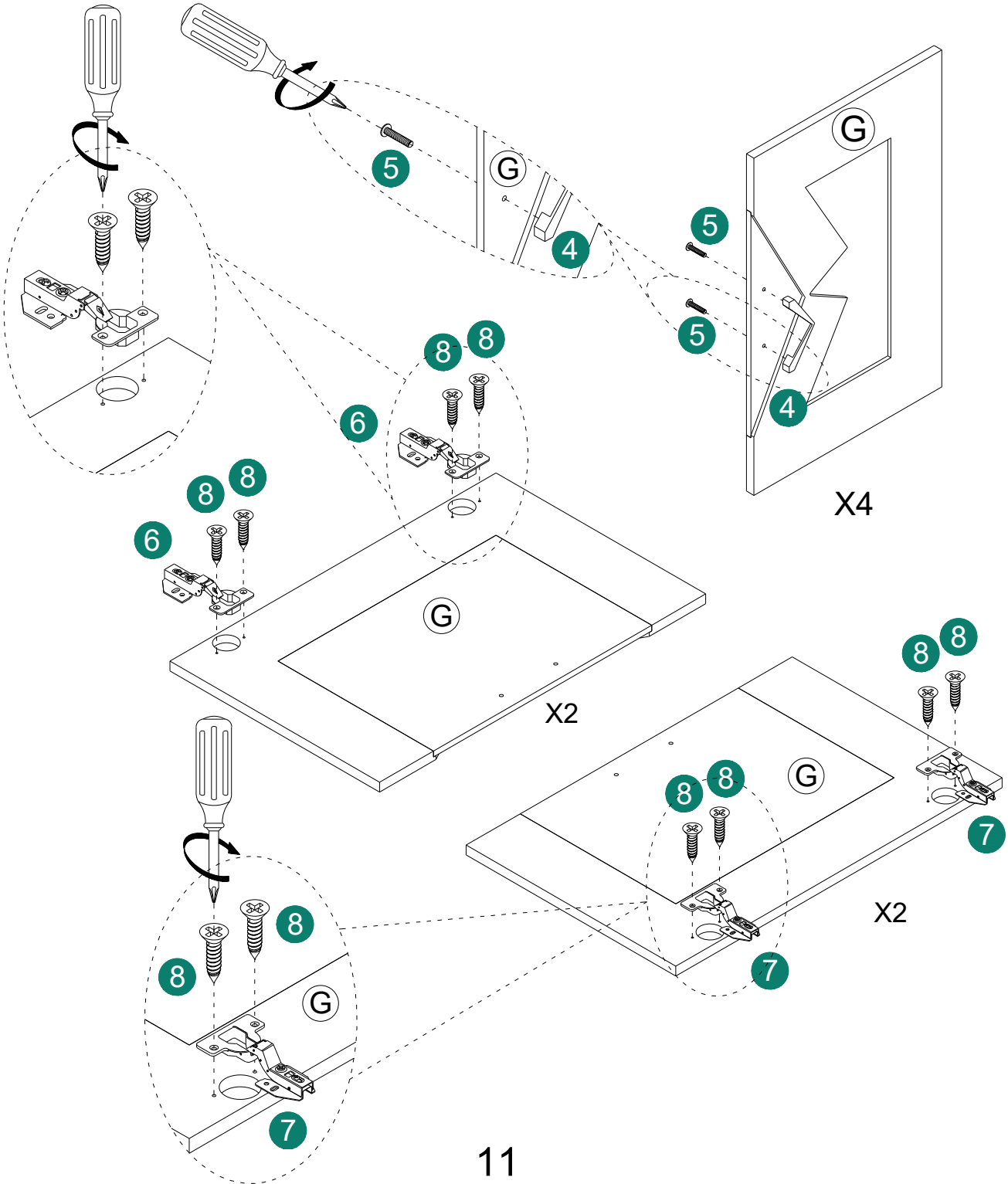
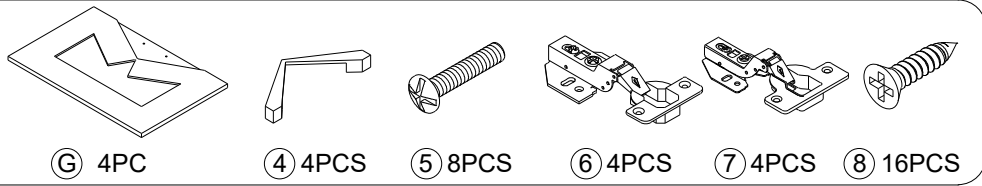

ASSEMBLY INSTRUCTIONS

8

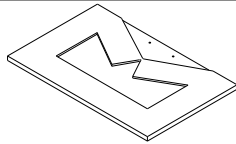

G 2PC

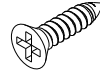

8 16PCS

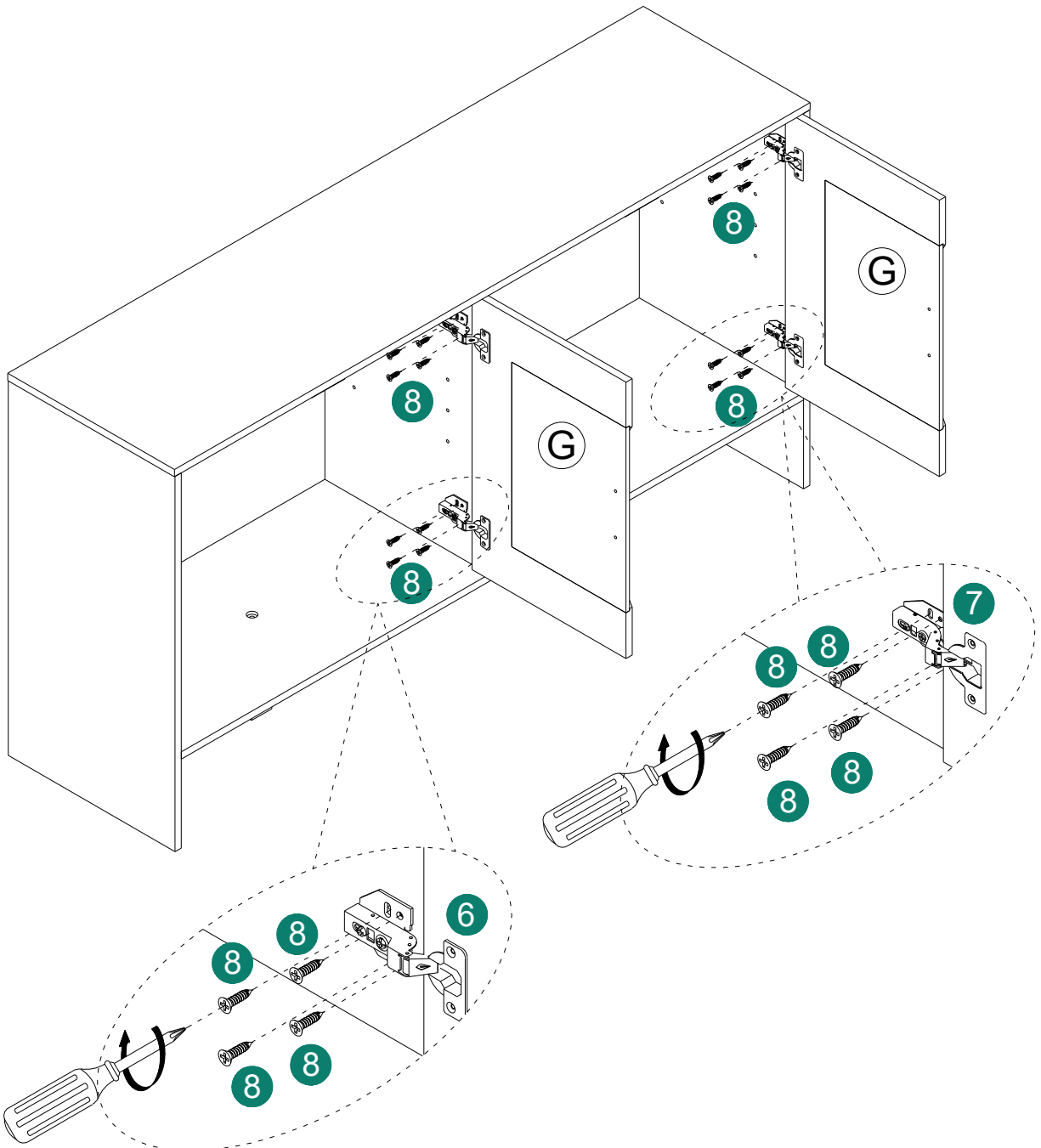

ASSEMBLY INSTRUCTIONS

9

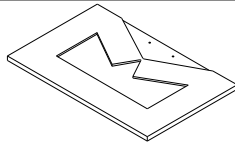

ⓐ 2PC

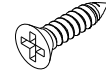

Ⓟ 16PCS

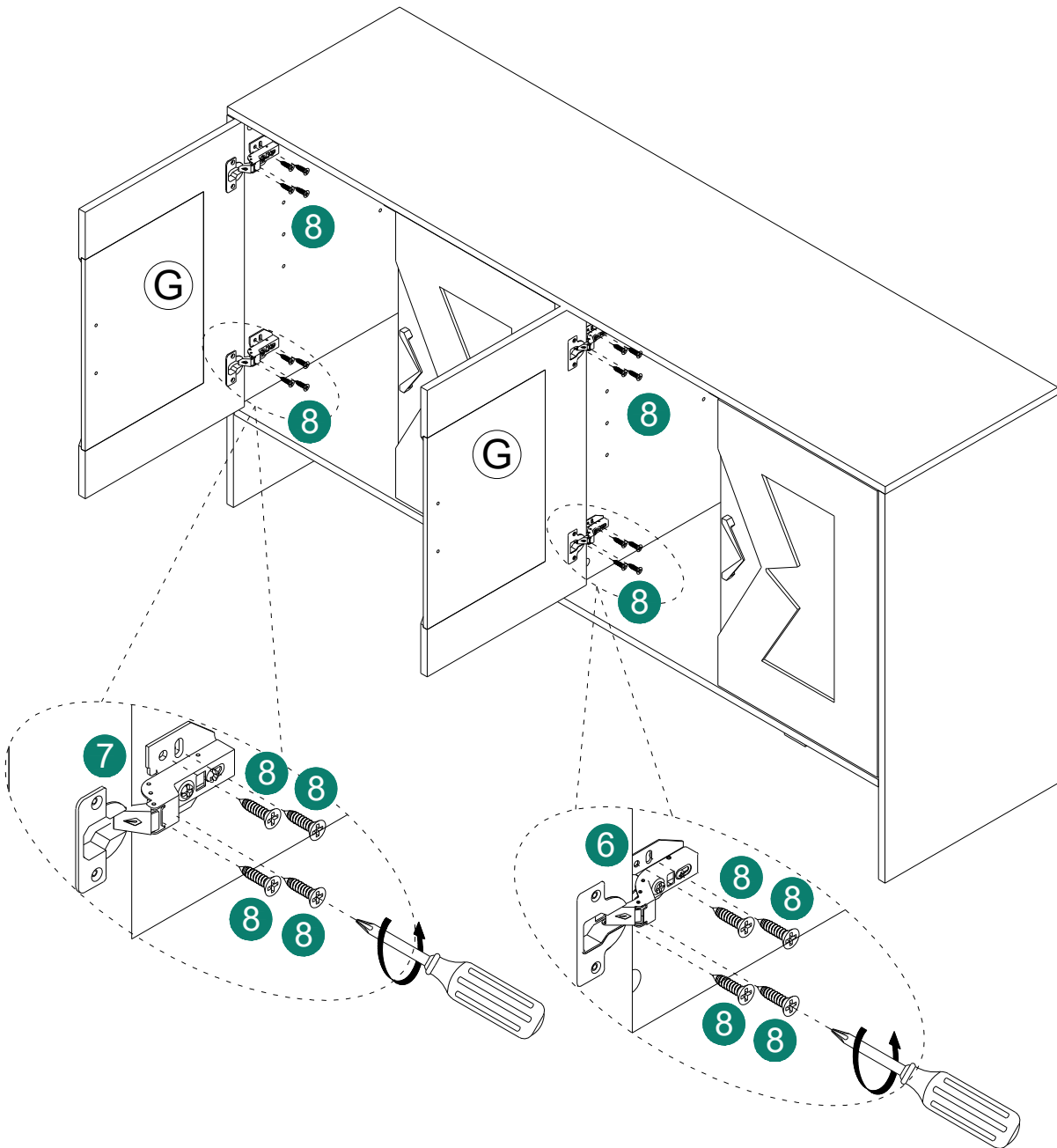

ASSEMBLY INSTRUCTIONS

10

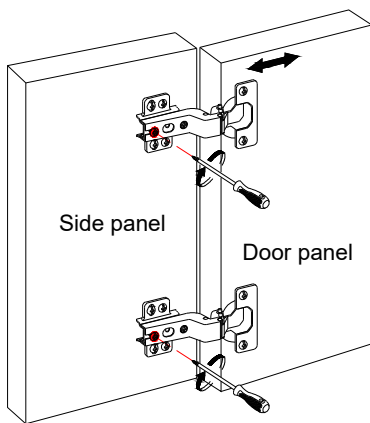

①

Front-to-Back Direction Adjustment:

Rotate the screws on the door hinges shown in the image. The door panel can be moved front-back.

Adjustment range: 4mm

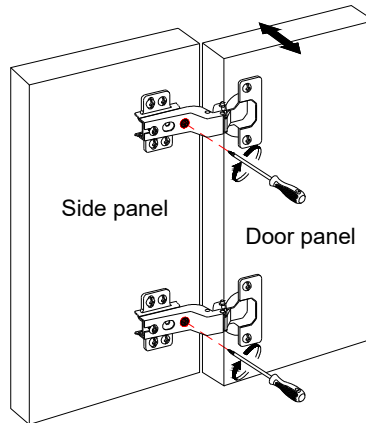

②

Left-Right Direction Adjustment:

Rotate the screws on the door hinges shown in the image. The door panel can be moved left-right.

Adjustment range: 3mm

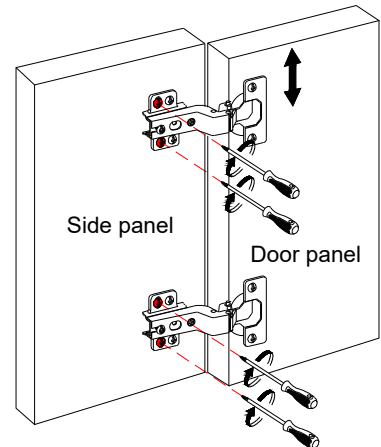

③

Up-Down Direction Adjustment:

Rotate the screws on the door hinges shown in the image. The door panel can be moved up-down.

Adjustment range: 4mm

ASSEMBLY INSTRUCTIONS

11

Common Door Panel Issues:

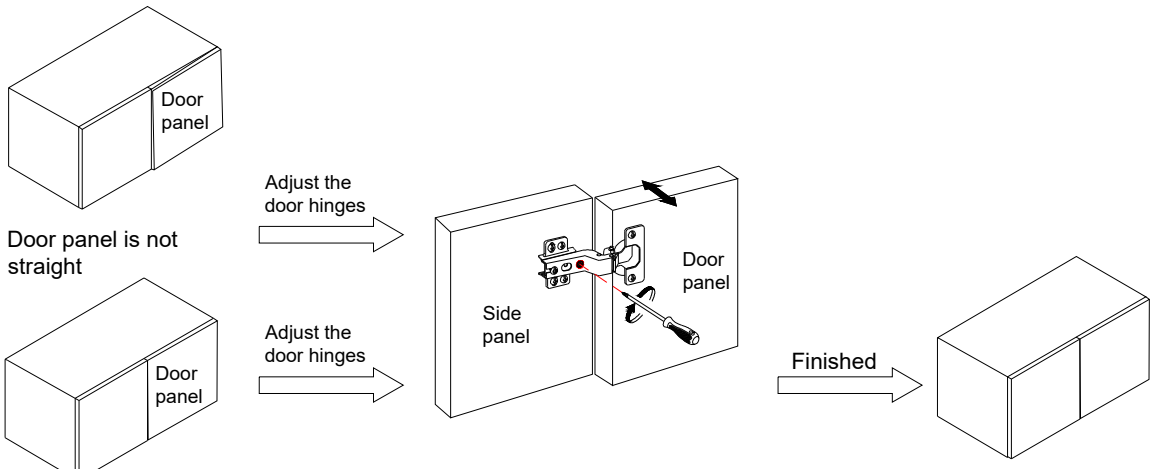

The gap between door panels is too large

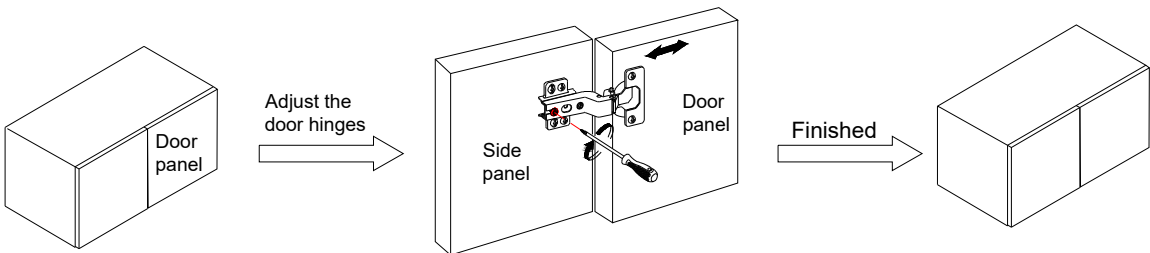

The door panels are not coplanar

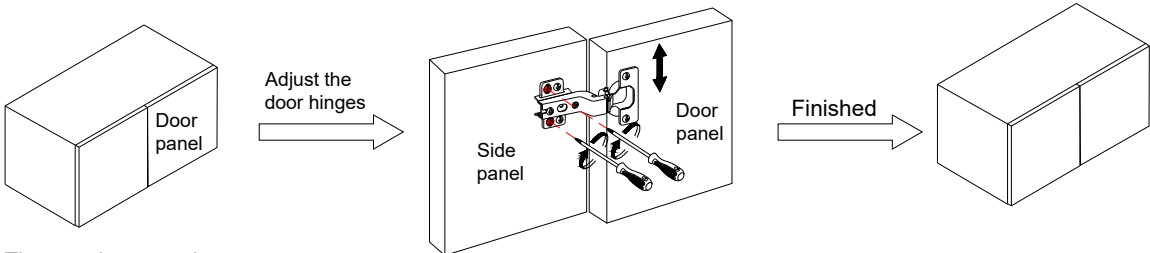

The two door panels are not at the same height

ASSEMBLY INSTRUCTIONS

12



⑨ 8PCS

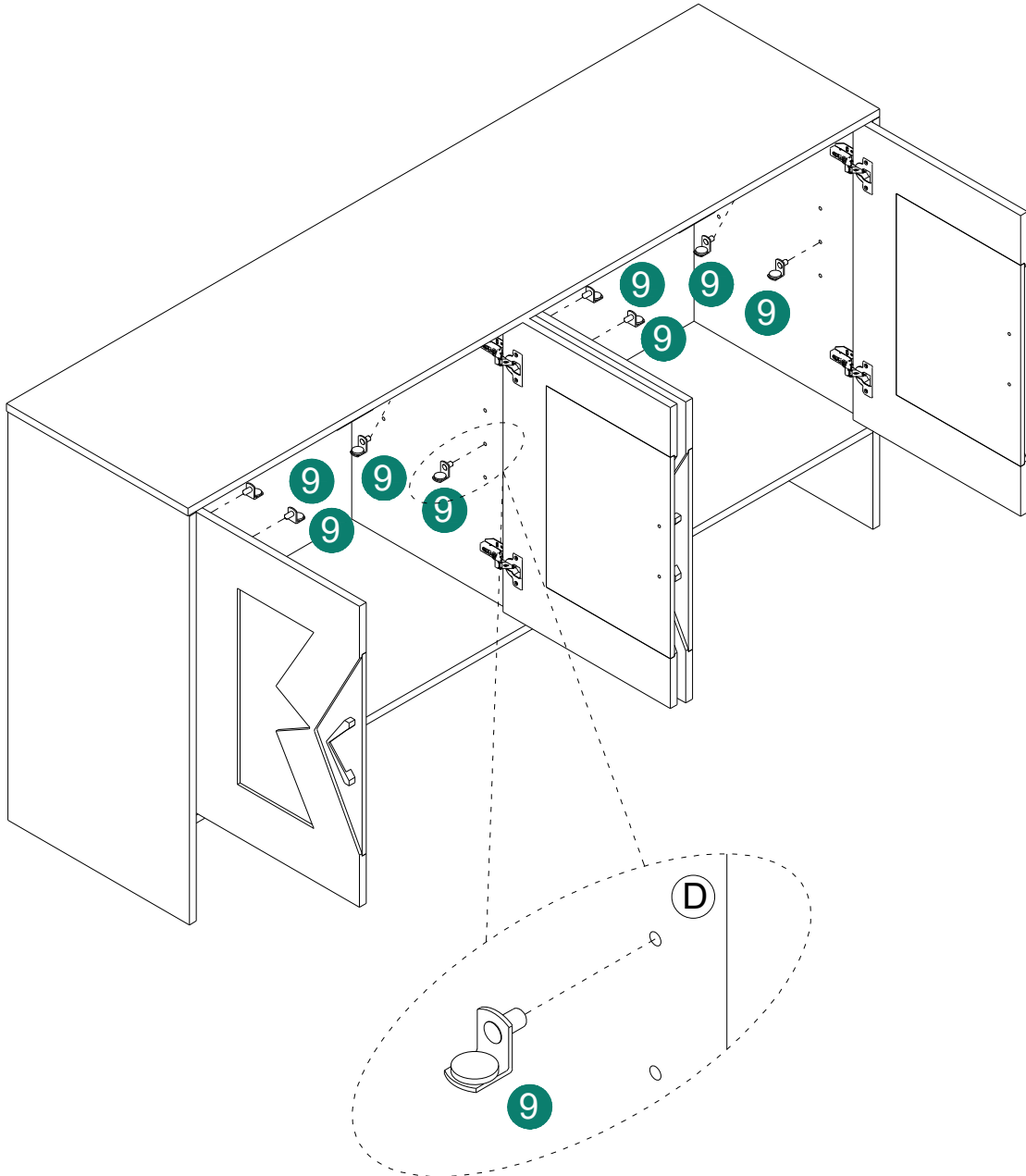

ASSEMBLY INSTRUCTIONS

13

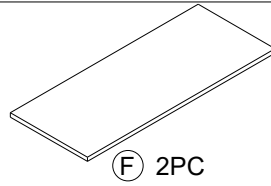

F 2PC

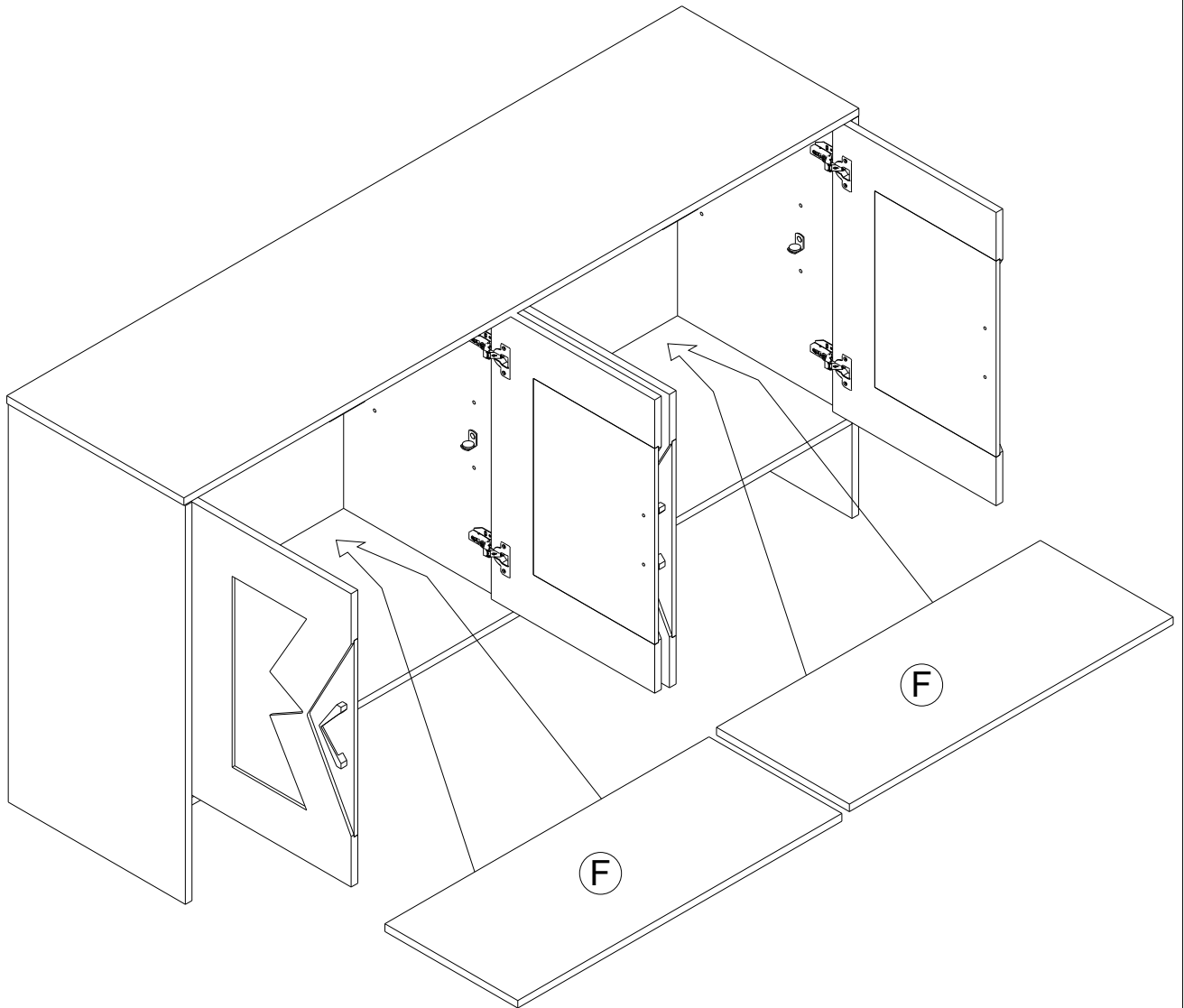

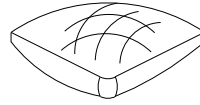

ASSEMBLY INSTRUCTIONS

14

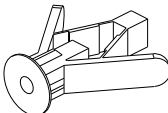

14 2set

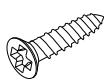
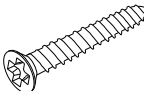
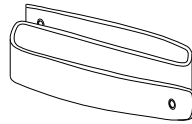
A	B	C	D	E
				
2pcs	4pcs	Ø8*3/4" 2pcs	Ø8*1-1/2" 2pcs	2pcs

