

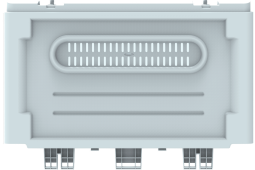







ASSEMBLY INSTRUCTIONS

- 1-Piece
DOG HOUSE



Parts

 <p>A</p> <p>x1</p>	 <p>B</p> <p>x2</p>	 <p>C</p> <p>x1</p>
 <p>D</p> <p>x1</p>	 <p>E</p> <p>x1</p>	 <p>F</p> <p>x1</p>
 <p>G</p> <p>x1</p>	 <p>H</p> <p>x4</p>	 <p>I</p> <p>x4</p>

Assembly steps

Step 1

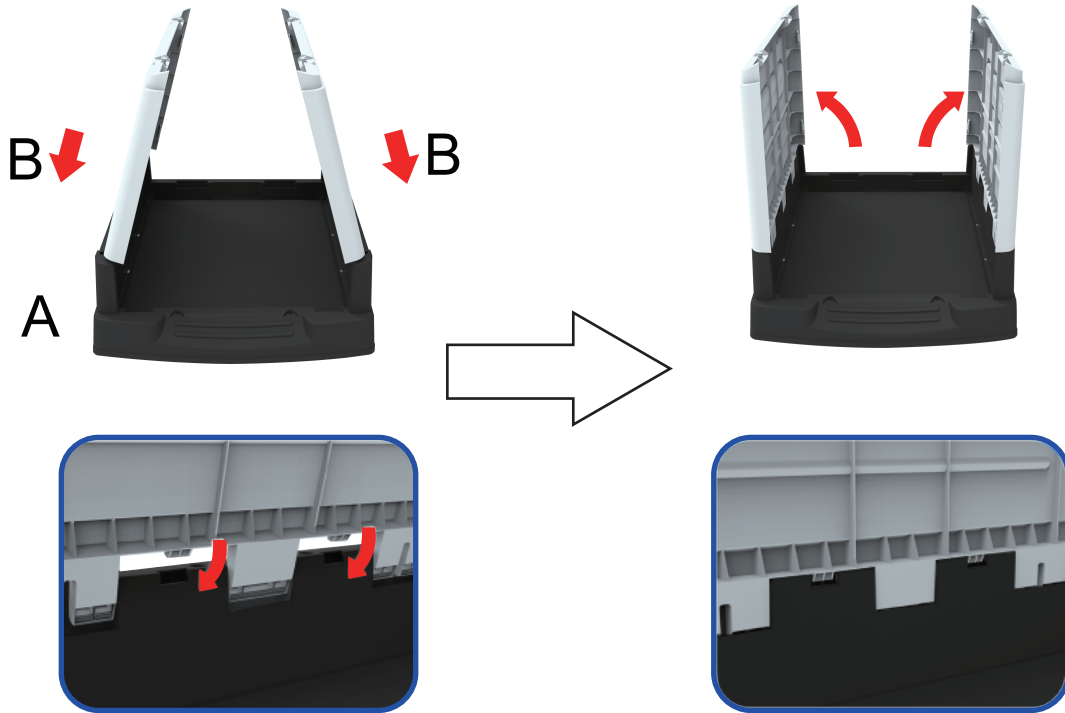

Step 2

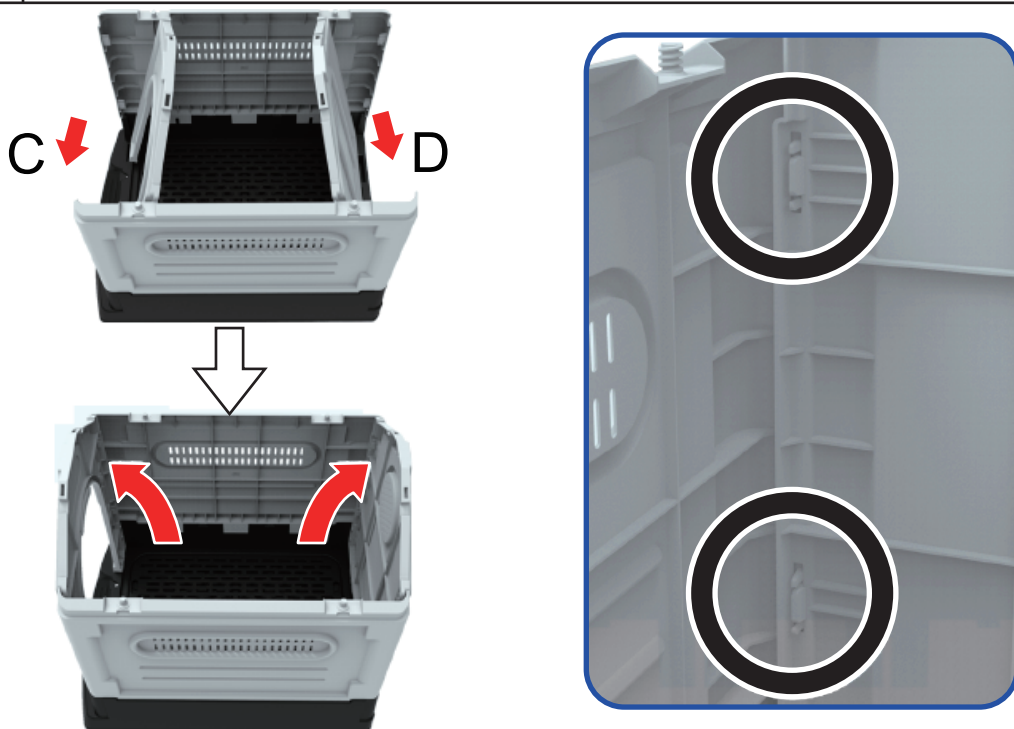

Assembly steps

Step 3

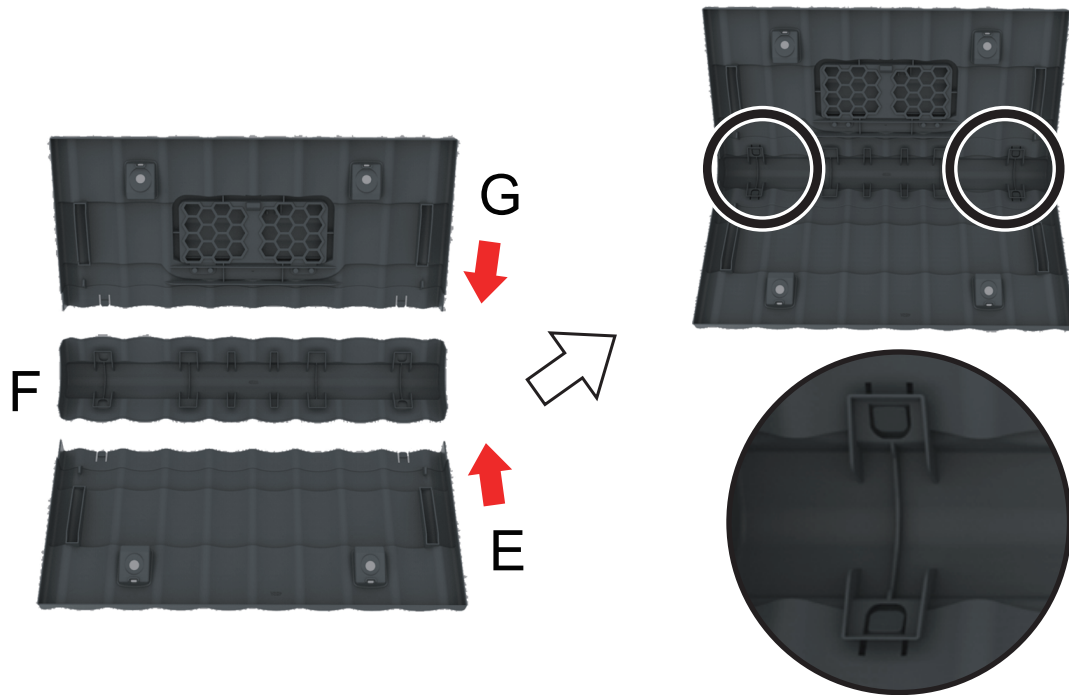

Step 4

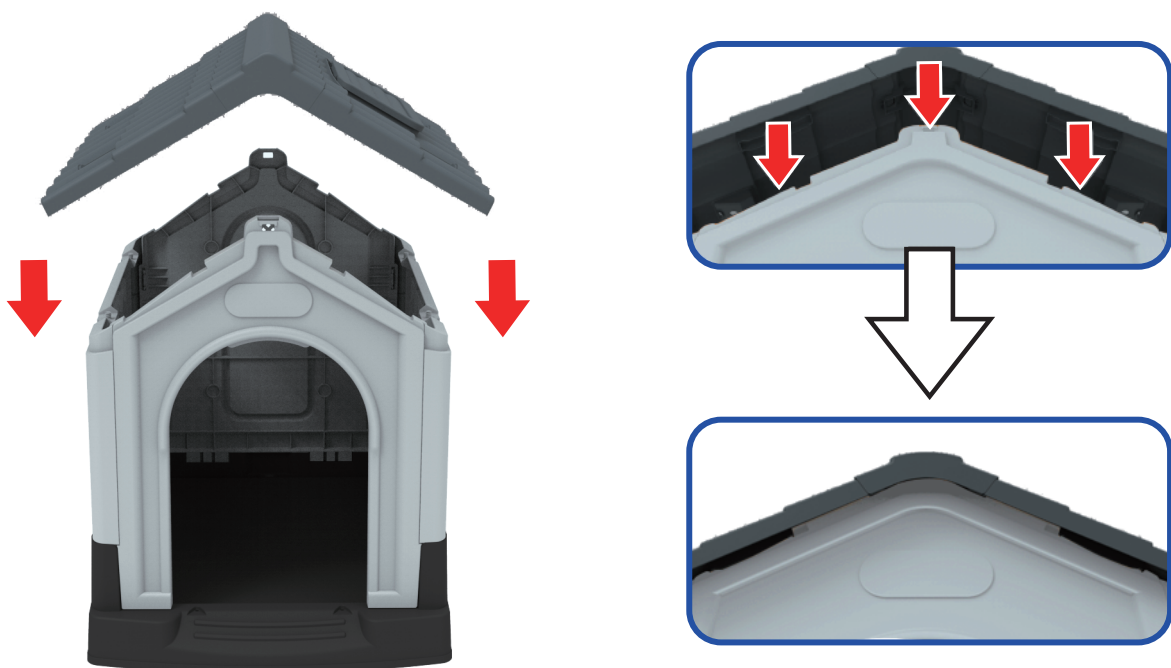

Assembly steps

Step 5



H (X4)



I (X4)

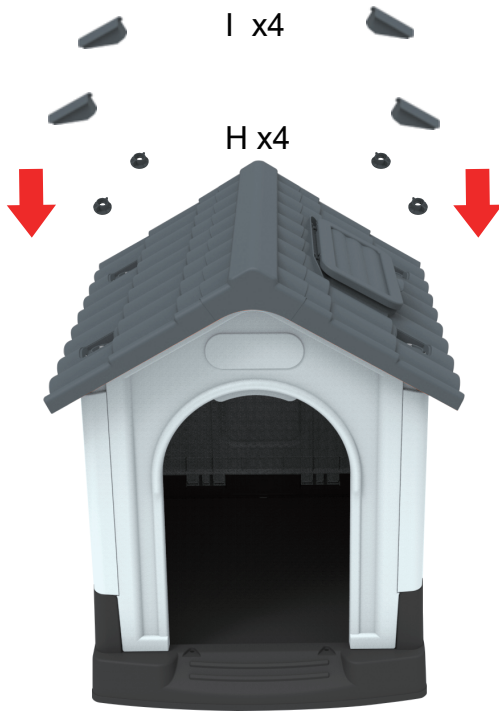

Step 6

