



User's Manual







BEFORE INSTALLATION

► Installation Environment

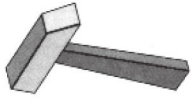
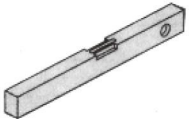
1. Before installation, confirm whether the inlet pipe and angle valve are correct. Make sure that the installation is completed, and the water has been flushed to ensure that there are no impurities in the water inlet pipe;
2. Water inlet pressure requirements: $5\text{bar} \geq \text{inlet pressure} \geq 0.5\text{bar}$, it is recommended to install a pressure reducing valve if it is greater than 0.05MPa ;
3. When installing and using the faucet, please use normal torque to prevent the handle from breaking.
4. If the customer goes out for a long time or does not use the faucet for a long time, please close the faucet valve and turn on the faucet switch to release the pressure and water in the faucet.

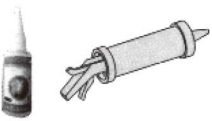
► Installation Aids

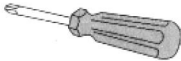
		
Hammer	Spirit level	Adjustable wrench
		
Glue (do not use glue containing acetic acid)	Impact drill	Screwdriver

► Parts List

NO.	Item	Qty
1	Water knockout drum	1
2	Slider	1
3	Top shower tube	1
4	Curved foot cover	2
5	Water inlet joint	1
6	Holder	1
7	Screw packet	1

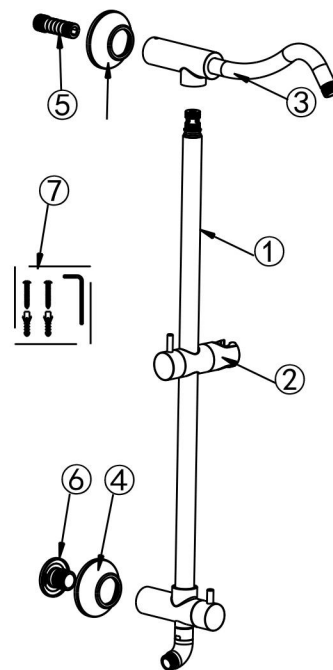

Check accessories

Standard List of Accessories:

When you open the product packaging, please check whether the objects in it are consistent with the main body and accessories you purchased. If there is any inconsistency, please contact our company or our distributor.

Note: 1. Accessories are subject to change without prior notice if the change does not affect usage;

2. The appearance of the product is subject to the physical objects you receive, and the schematic diagram is only for reference.

INSTALLATION STEPS

This product has been inspected and debugged by the factory to the best condition. Please do not disassemble and assemble it yourself.

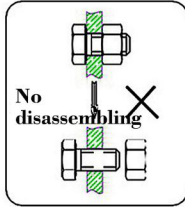

Before installing the faucet, please be sure to remove sundries and sludge from the water pipe to prevent sundries from blocking the faucet.

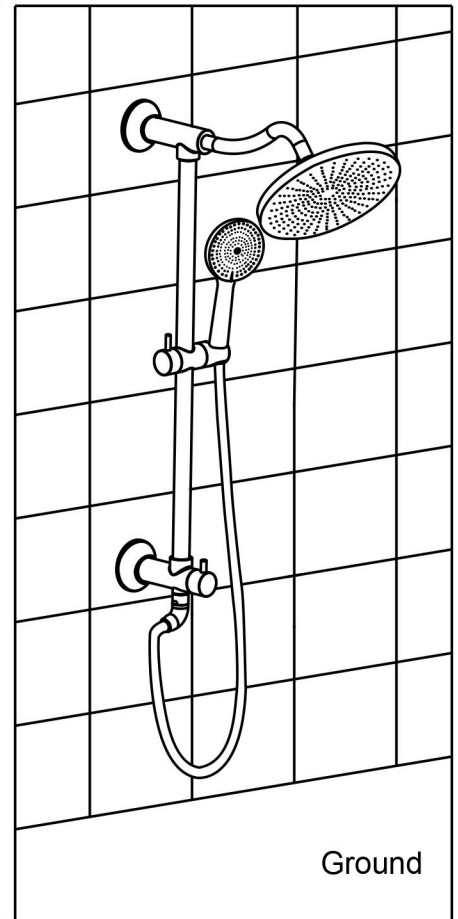
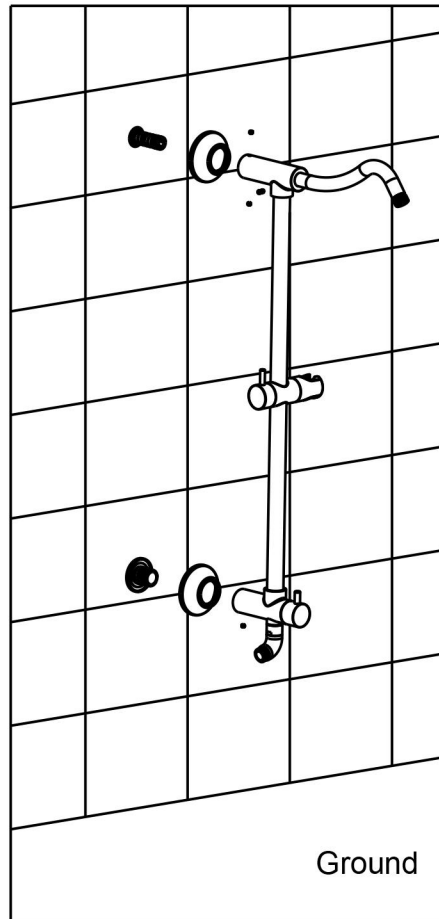
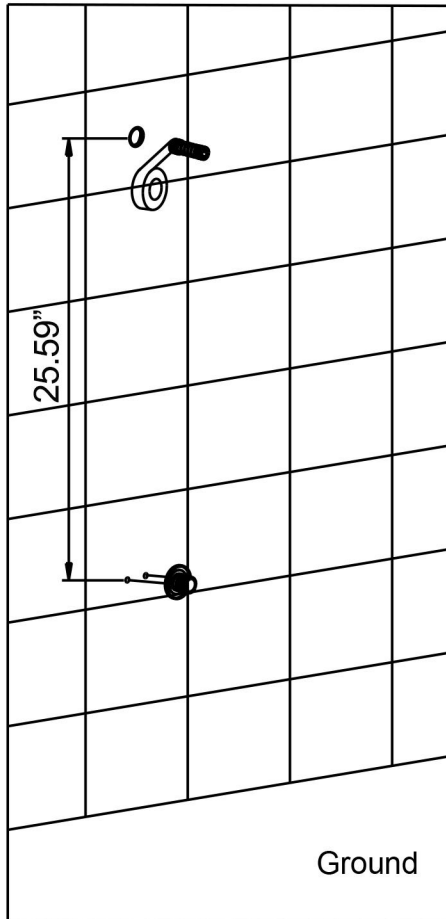
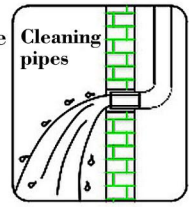

1. Wrap water inlet joint with the raw material tape and connect it with the water pipe embedded in the wall.
2. Attach the decorative cover to water inlet joint on the wall.
3. Measure the mounting position of the fixing seat according to the actual size of the product. After making the mark, drill a hole on the wall and punch the self-tapping rubber particles into the hole, then use the self-tapping screw to fix the fixing seat on the wall, and then set it firmly on the decorative cover.
4. Insert the water knockout drum into the top shower pipe, adjust the position with a pole into the fixing seat on the wall, adjust the position and tighten it with a hexagonal wrench. If the position is slightly misaligned when the product is installed, the eccentric joint and fixing seat can be adjusted appropriately. and tighten it with a hexagonal wrench, and then connect it with the water inlet connector, tighten it with a hexagonal wrench, then insert the fixing seat on water knockout drum to the fixing seat on the wall, adjust the position and tighten.

INSTALLATION STEPS

► Test method

1. Turn the faucet handle to the closed position, open the water inlet valve, and check whether there is any leakage at all water inlet ports.
2. Open the faucet handle to the maximum, and open the water inlet valve to check whether there is leakage at the water outlet and the sprinkler connection port.
3. Operate the reversing valve several times to check the shower water condition and whether there is any leakage outside the connection.
4. If the water pressure is lower than 0.05M Pa (it is possible that the faucet drips while the shower sprinkles water, or the faucet reversing valve does not work), a booster pump should be installed in the pipeline.

INSTALLATION DIMENSION

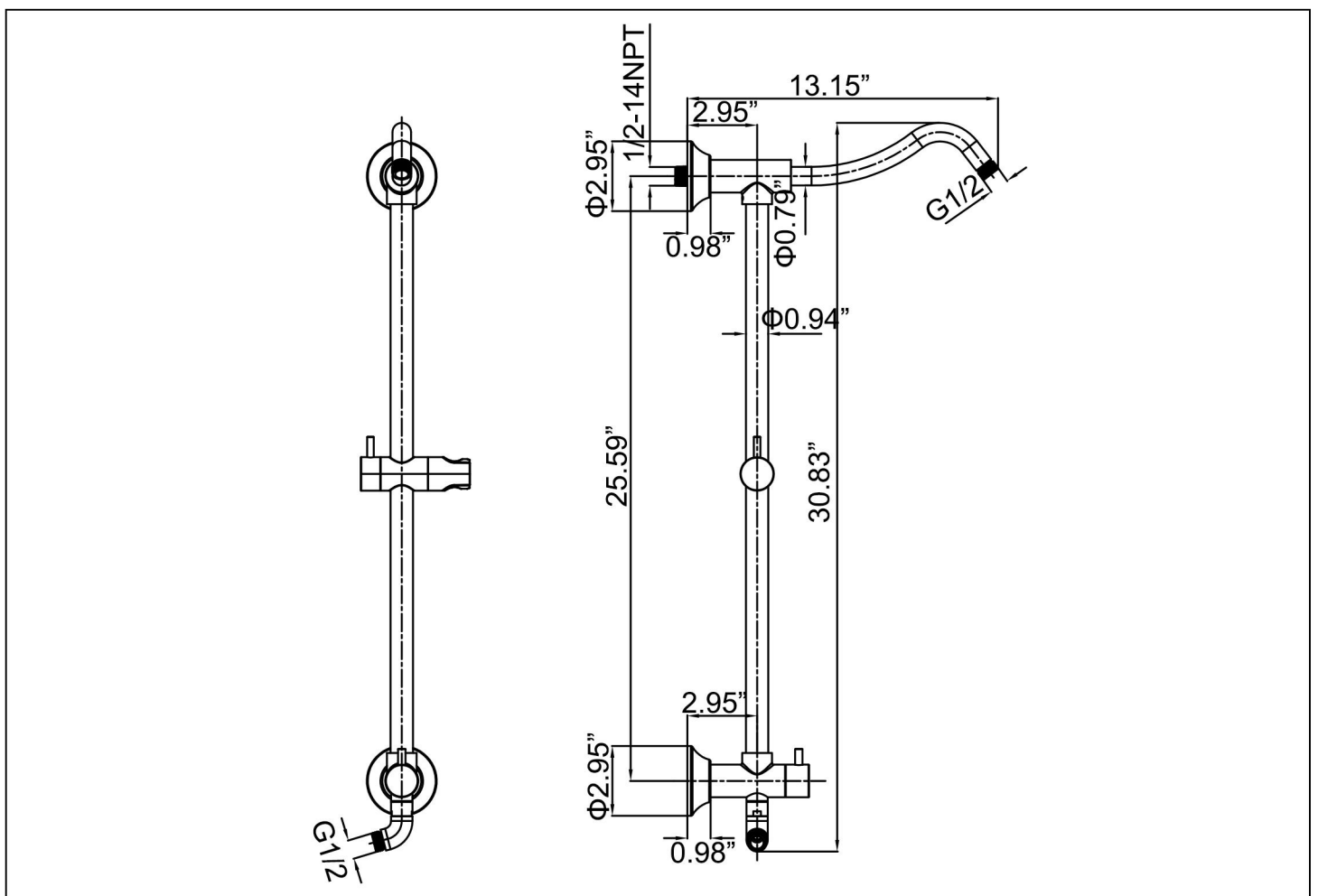

CLEANING CARE

In order to keep the appearance of faucet clean, bright and good performance, please take care of the faucet as follows;

1. Rinse with water only and dry with soft cotton cloth;
2. Use mild liquid and colorless glass cleaner to remove surface dirt and scale film, or use polish without abrasive effect;
3. Do not use abrasive detergent, polish, emery cloth, paper towel or scraper, etc.;
4. Do not use acid cleaner, or cleaner and soap with insoluble gran etc.;
5. In the process of use, mud may accumulate in the bubbler and make the water flow show, The bubbler can be unscrewed, rinsed with water, and then installed back in place.



Please feel free to contact us if you have any questions. We will help to solve the issue together with you. OUR EMAIL: services@rbrohant.com



Service Contact:
+1(801) 800-9309
services@rbrohant.com

Made in China