







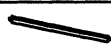

# ASSEMBLY INSTRUCTIONS

Dimensions : 25"H x 18"W x 38"L

Desc : BENCH CHAIR

LIST OF HARDWARE		
A : SEAT FRAME		1pc
B : LEG		4pcs
C : LONG STRETCHER		2pcs
D : SHORT STRETCHER		2pcs
E : MEDIUMS STRETCHER		1pc

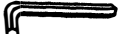
LIST OF HARDWARE				
F	BOLT		φ1/4" x 63.5 mm	8pcs
G	LOCK WASHER		φ1/4"	8pcs
H	METAL WASHER		φ1/4"	8pcs
I	WOOD SCREW		φ 8 x 38 mm	10pcs
J	ALLEN KEY		4 mm	1pc

## STEP 1

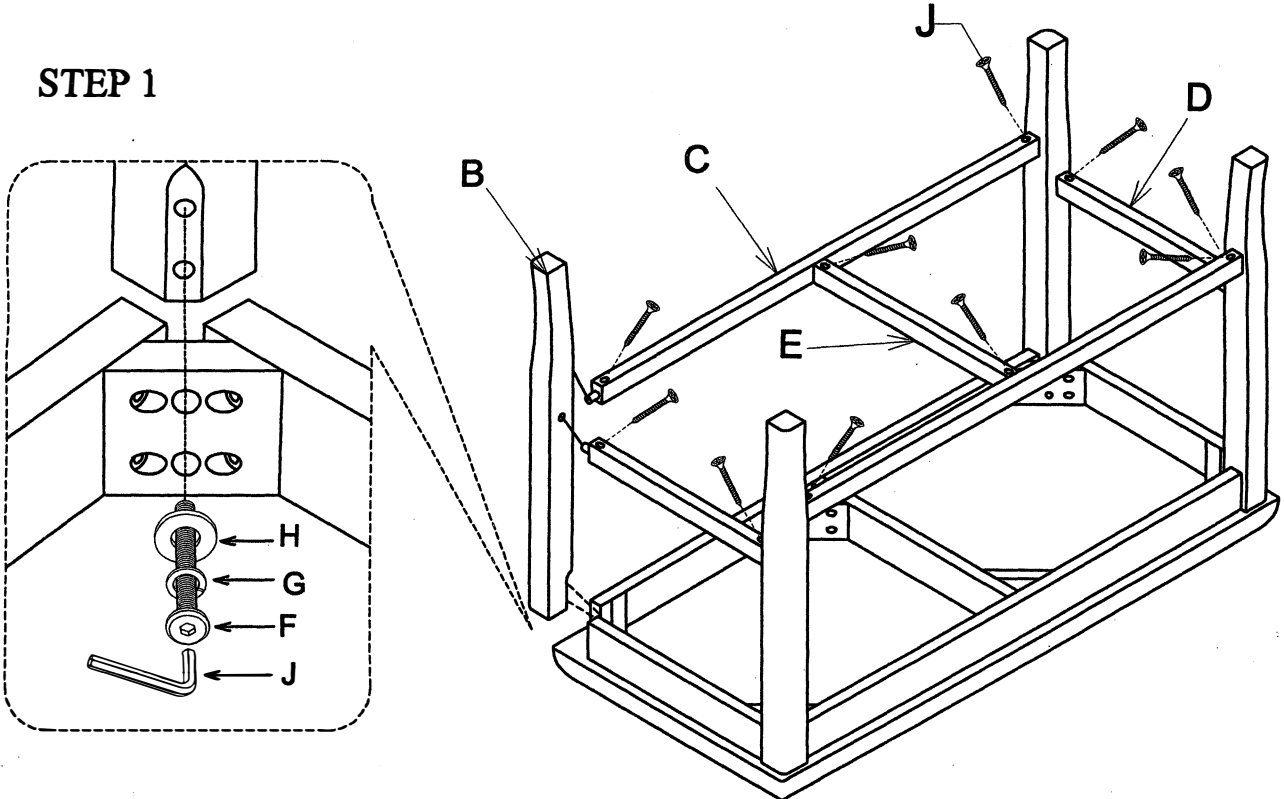

## STEP 2

