

IF YOU FIND A DEFECTIVE PART

We fully stock all parts and components. Any defective part can be quickly replaced. Take note of the defective part number in manual and we will arrange a quick replacement.

COPYRIGHT

Any unauthorised use may violate worldwide copyright, trademark and other laws.

Thank you for purchasing!

Instruction manual 2 Seat Sofa

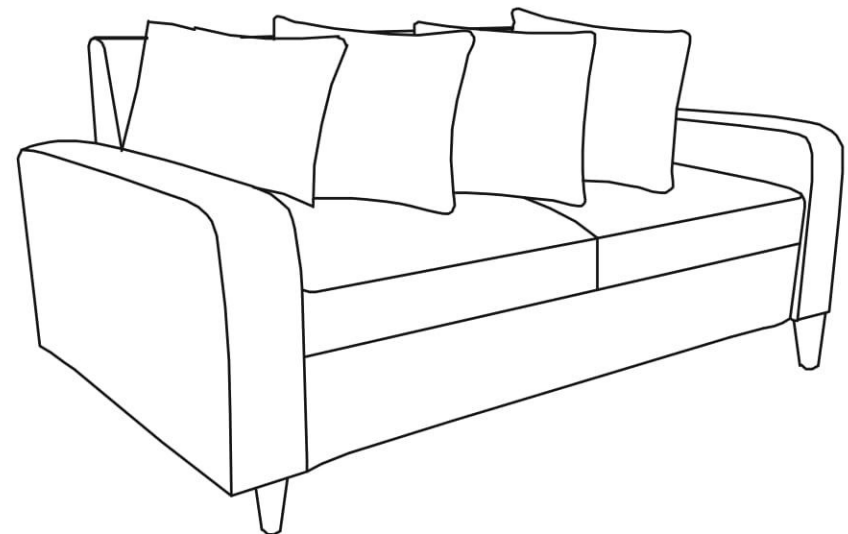

ASSEMBLY INSTRUCTIONS

Step 9

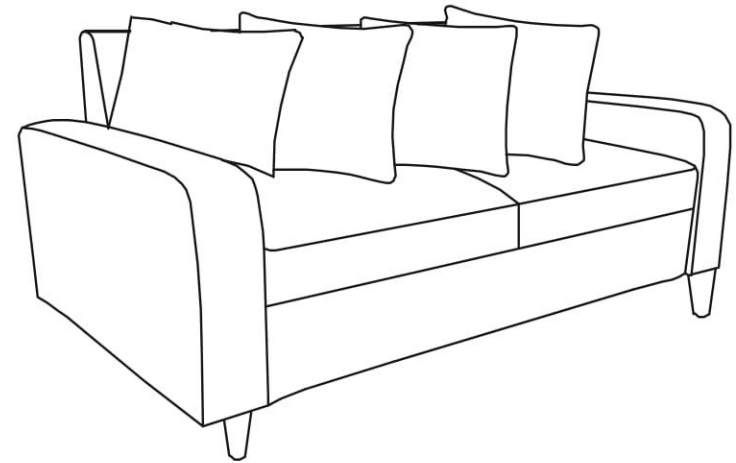
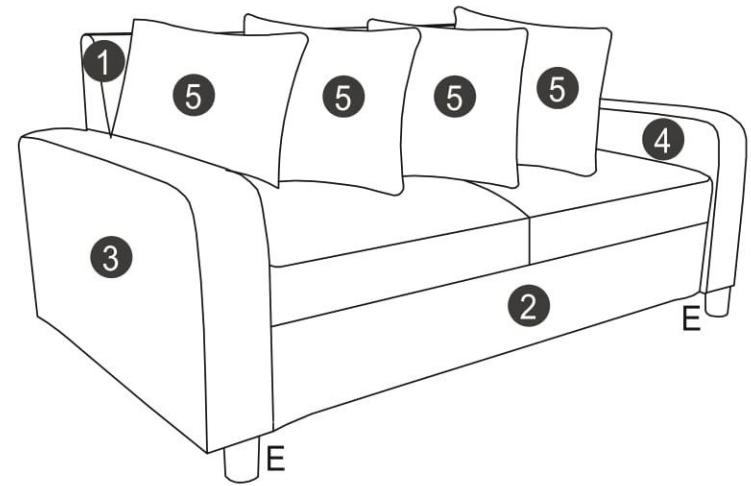

Congratulations! Now you have finished assembling the product.

ASSEMBLY INSTRUCTIONS

Step 7

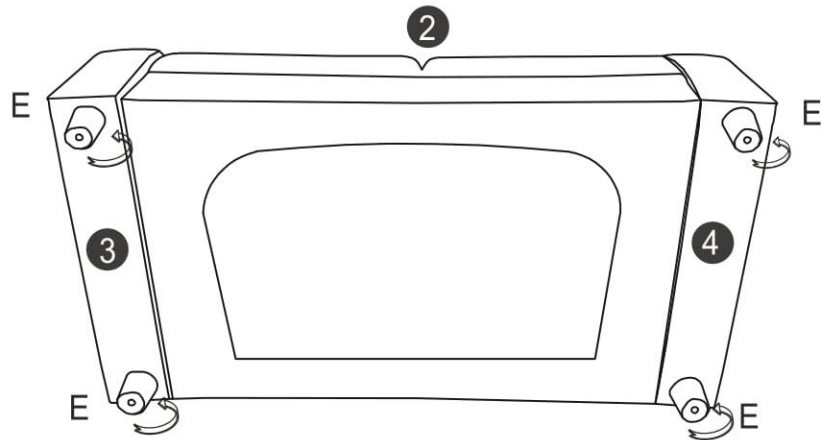

Step 8

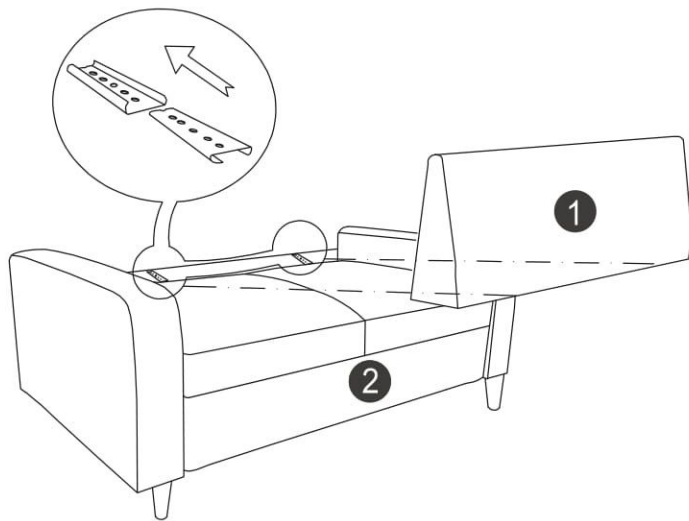

CONTENTS

Safety and care advice	1
Components	2
Assembly instructions	4
Copyright	9

⚠ SAFETY AND CARE ADVICE ⚠

PLEASE READ THESE INSTRUCTIONS CAREFULLY AND KEEP FOR FUTURE REFERENCE

- **Warning:** Please lift with care.
- Check you have all the components and tools listed on pages 2 and 3.
- Remove all fittings from the plastic bags and separate them into their groups.
- Keep children and animals away from the work area, small parts could choke if swallowed.
- Make sure you have enough space to lay out the parts before starting.
- Do not stand or put weight on the product, this could cause damage.
- Assemble the item as close to its final position (in the same room) as possible.



- Assemble on a soft level surface to avoid damaging the unit or your floor (use opened out unit carton).
- We do not recommend the use of power drill/drivers **for inserting screws**, as this could damage the unit. Only use hand screwdrivers.
- Dispose of all packaging carefully and responsibly.

CARE AND MAINTENANCE

- Only clean using a damp cloth and mild detergent, do not use bleach or abrasive cleaners.
- From time to time check that there are no loose screws on this unit.

• This product should not be discarded with household waste. Take to your local authority waste disposal center.

Note If required the next page can be cut out and used as reference throughout the assembly. Keep this page with these instructions for future reference.

ASSEMBLY INSTRUCTIONS

Step 5

A		4
---	--	---

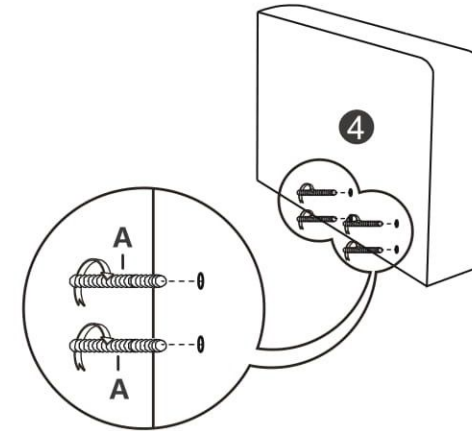

Step 6

B		4
C		4
D		1

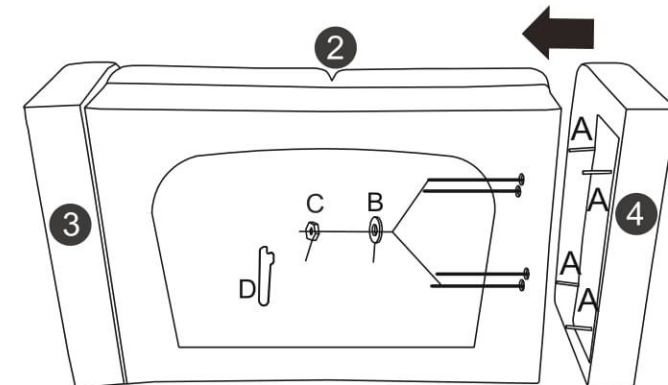

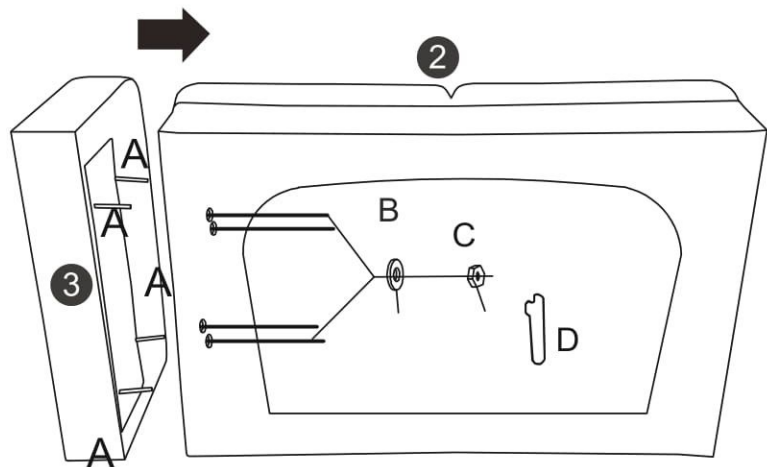

ASSEMBLY INSTRUCTIONS

Step 3



Step 4

B		4
C		4
D		1

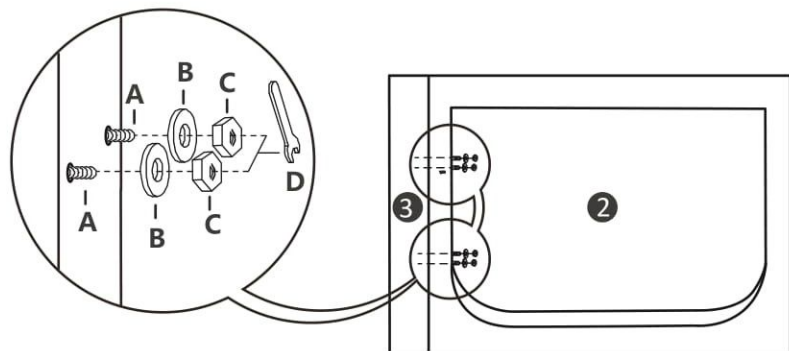

COMPONENTS — PARTS

Please check you have all the parts listed below:

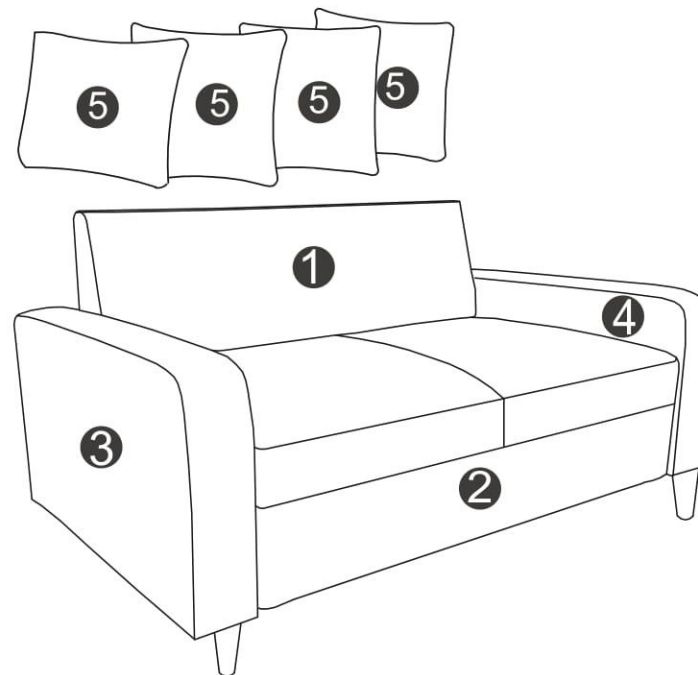

PARTS LIST

1	Sofa Backrest	x1	4	Left Armrest	x1
2	Sofa Seat	x1	5	Backrest Pillow	x4
3	Right Armrest	x1			



COMPONENTS — FITTINGS

Please check you have all the fittings listed below:

A  Bolt x 8

B  Washer x 8

C  Nut x 8

D  Wrench x 1

E  Foot x 4

ASSEMBLY INSTRUCTIONS

Step 1

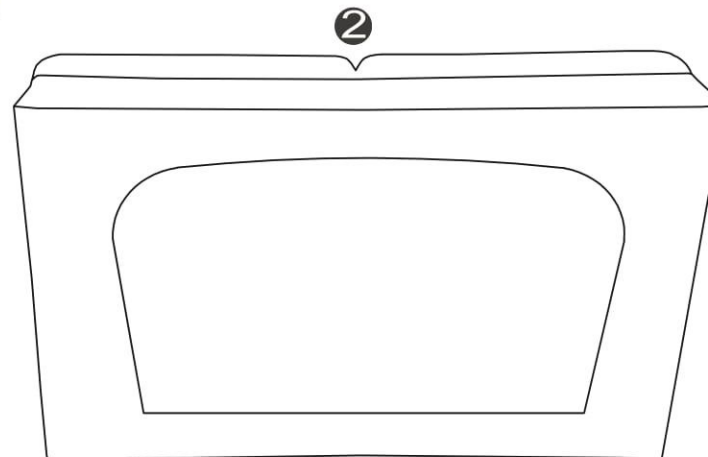

△ IMPORTANT:
Turn sofa upside down. Open the zipper which is under the sofa.
Inside you will find parts **3**, **4**, **5** x 4, **E** x 4 and all hardware.

Step 2

