





Assembly Instructions



Laying out all the parts and hardware and identifying each part as shown may help you when you assemble the table.

ITEM	PART	DESC.	QTY
A		Table top	1
B		Wooden leg	1
C		Wooden leg	1

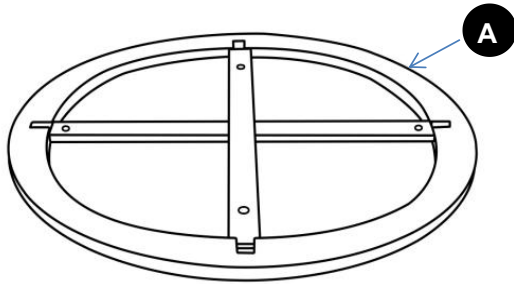
STEP ONE



Turn table top upside down on clean and soft surface.

ITEM	PART	DESC.	QTY
D		Bolts (6×40mm)	4
E		Allen Wrench	1
F		Flat washers	4

STEP TWO

承重: 25L

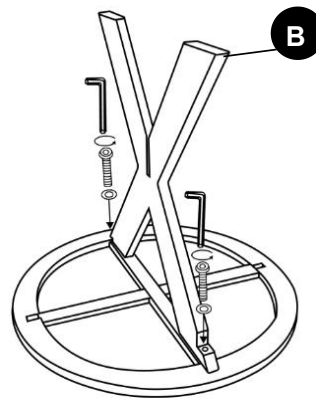

Attach wooden leg "B" to the bottom of the table top by bolts and flat washers as shown above.

STEP THREE

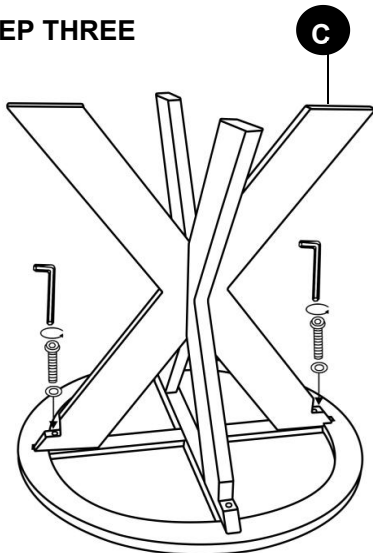

Attach wooden leg "C" to bottom of table top by bolts and flat washers.

STEP FOUR

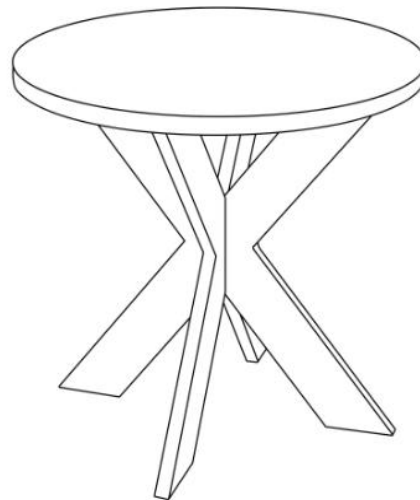

Turn the table upright. Please make sure all the bolts are fully tightened before using this table.



WARNING

- Do not let any sharp objects touch or rub the surface of the product.
- When assembling, do not let children play around the working area.
- Please confirm all parts are correct before starting the assembly process.
- Use only the Allen wrench provided. DO NOT USE POWER TOOLS.