

# Installation & Assembly

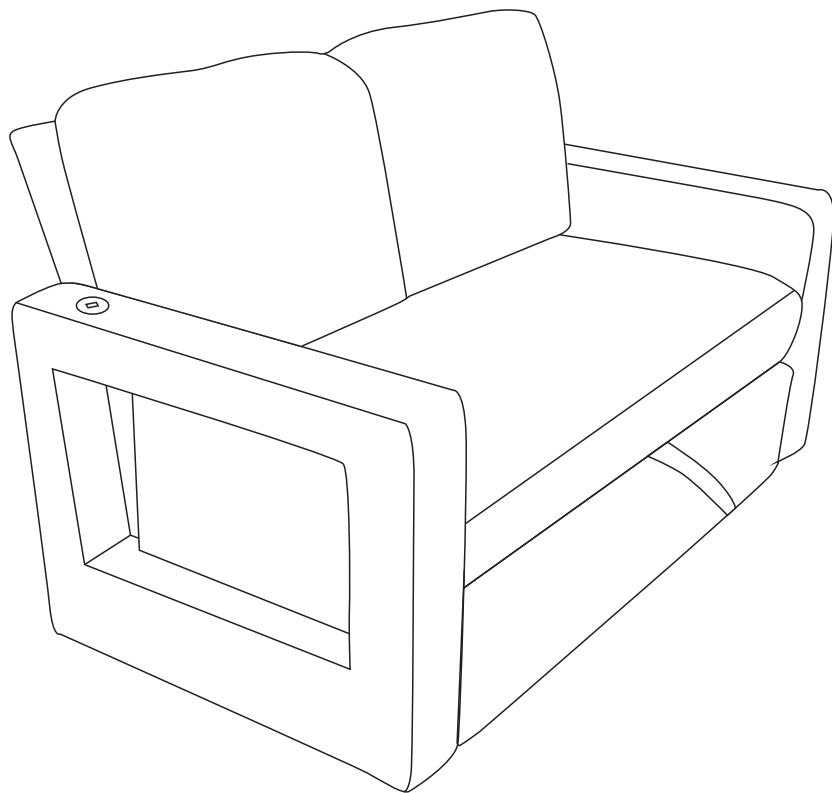









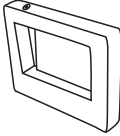
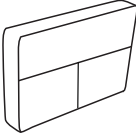
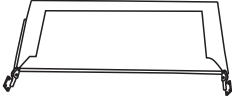
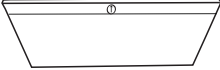
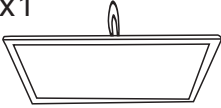
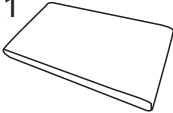
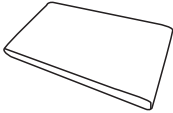
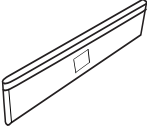
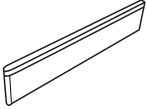



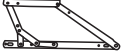
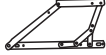

# **Please note :**



We provide fast after-sales service,  
don't worry if there is something  
wrong with the package you received.

Please contact us first, we will reply  
you in time!

# COMPONENTS

Ax2 		Bx1 		Cx1 	
Dx1 		Ex1 		Fx1 	
Gx1  115x65cm		Hx1  115x60cm		Ix1 	
Jx1 		Kx4 		Lx2 	
M-Lx1 	M-Rx1 	N-Lx2 	N-Rx2 	O-L x1 	O-R x1 
Px2 	Qx8 		Rx50  M6x20mm		Sx4  M6x40mm
Tx1 	Ux4 	Vx2 			

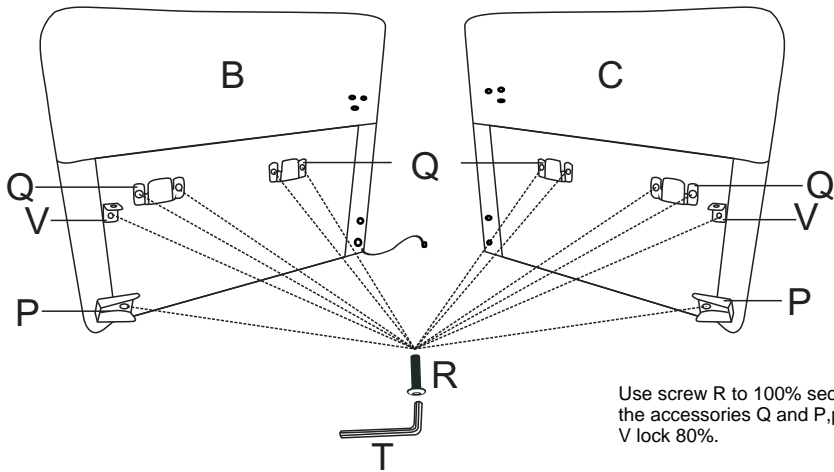

STEP1

R		12pcs
T		1pcs



Use screw R to 100% secure the accessories Q and P, part V lock 80%.

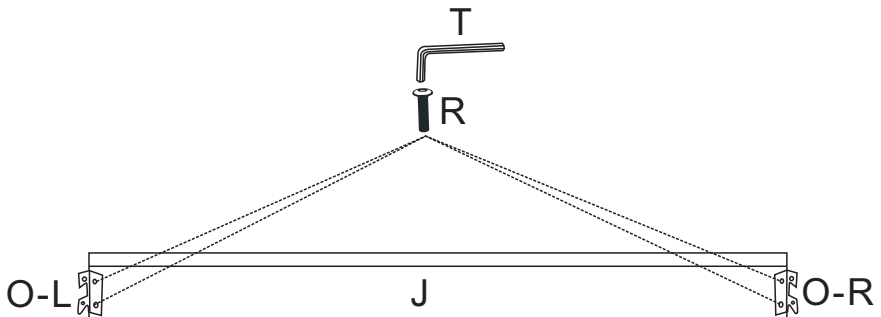

STEP2

R		4pcs
T		1pcs





Use screw R to 100% secure the accessories O-R and O-L.

STEP3

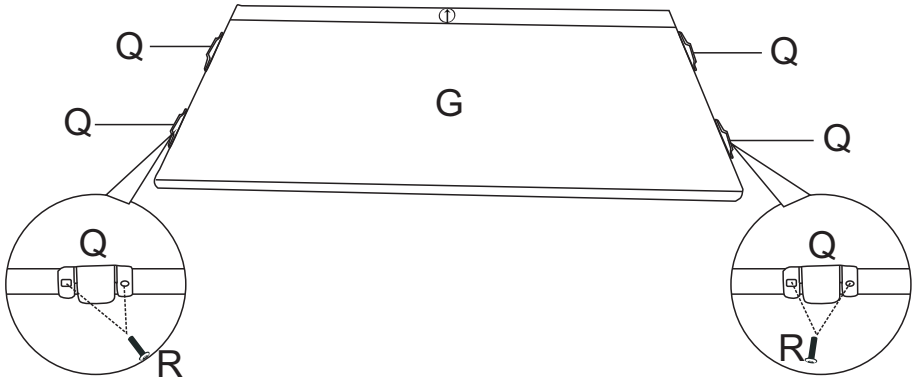
R		4pcs
T		1pcs



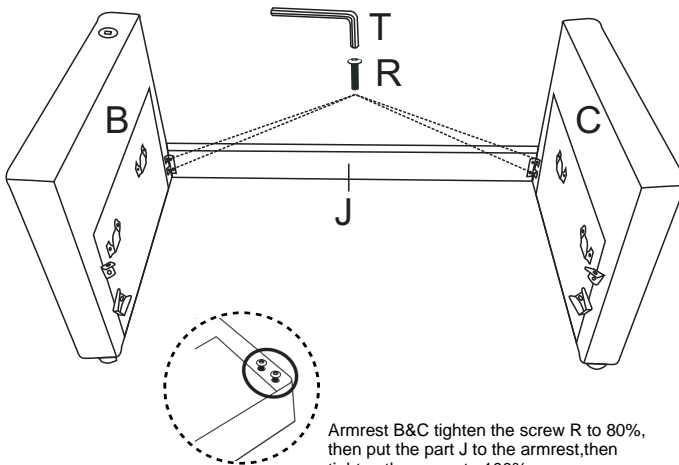

STEP4

R		4pcs
T		1pcs



Armrest B&C tighten the screw R to 80%, then put the part J to the armrest, then tighten the screw to 100%.

STEP5

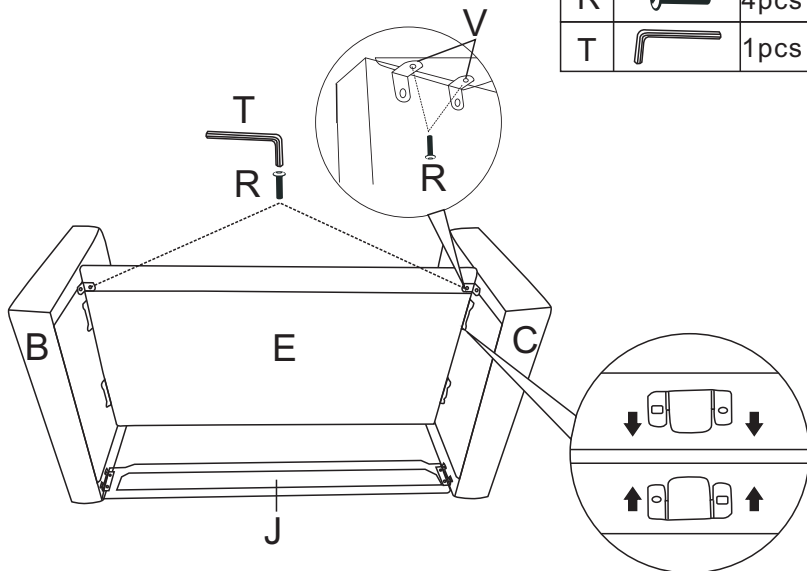

R		4pcs
T		1pcs



STEP6



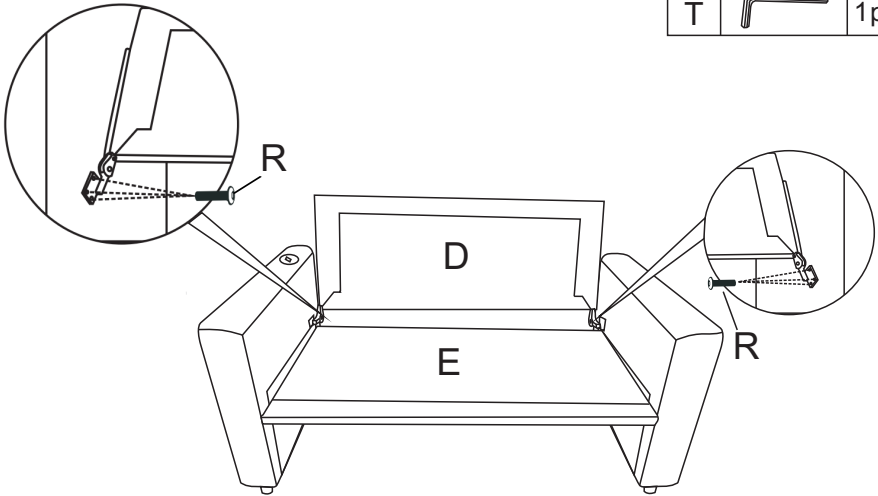

STEP7

R		6pcs
T		1pcs



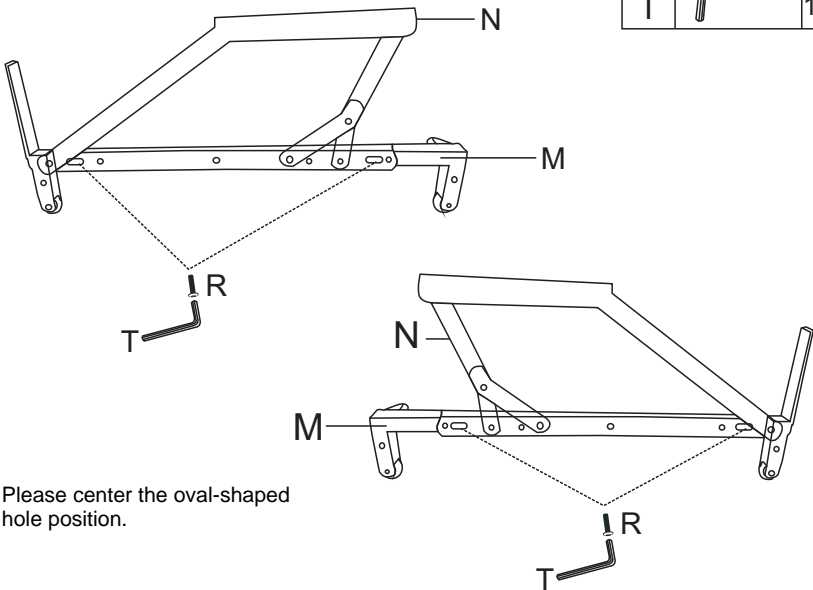

STEP8

S		4pcs
T		1pcs





Please center the oval-shaped hole position.

STEP9

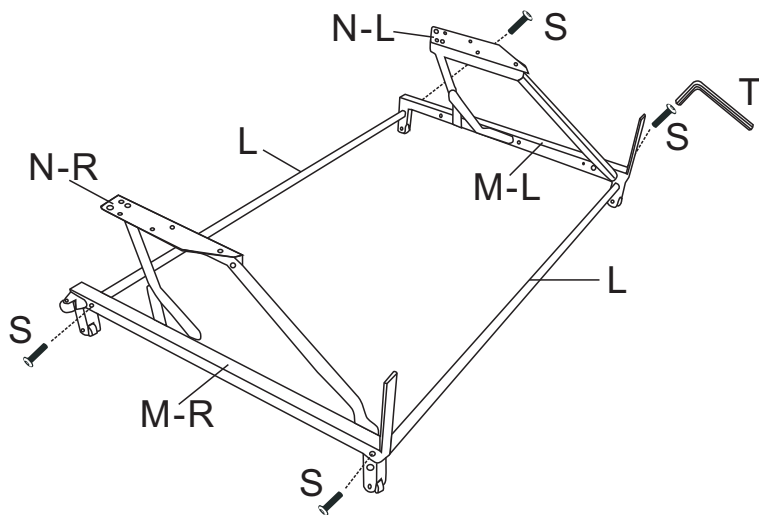
S		4pcs
T		1pcs



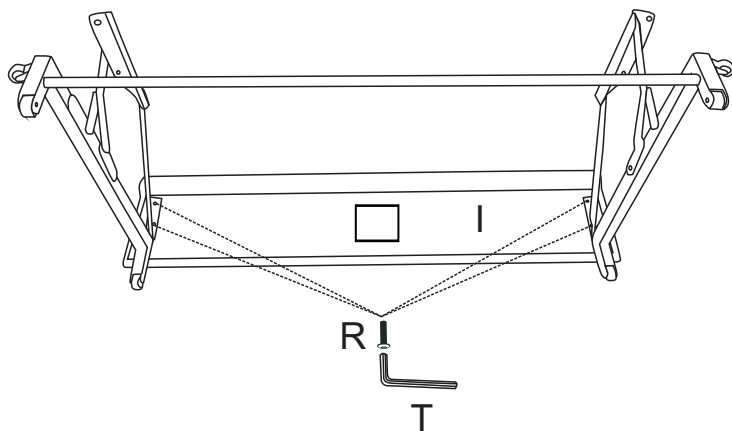

STEP10

R		4pcs
T		1pcs



STEP11

R		4pcs
T		1pcs

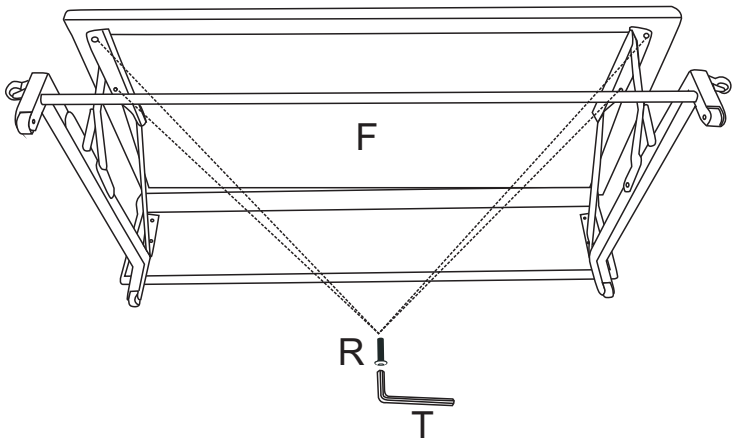

STEP12

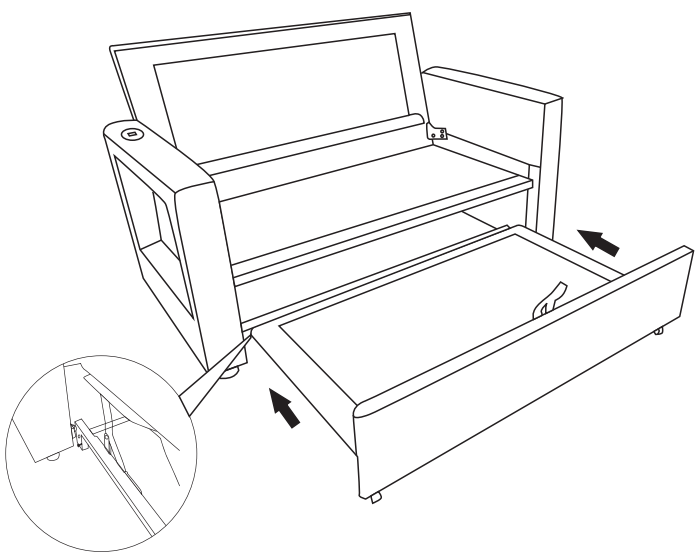

### STEP13

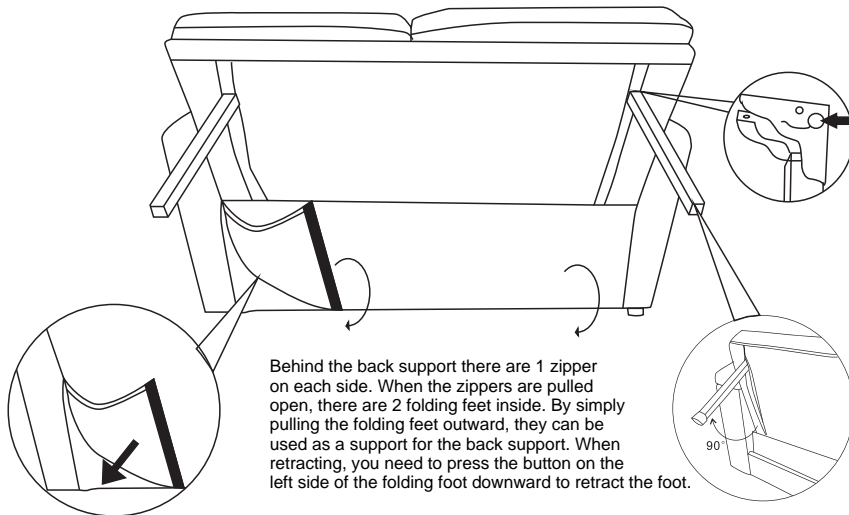

Behind the back support there are 1 zipper on each side. When the zippers are pulled open, there are 2 folding feet inside. By simply pulling the folding feet outward, they can be used as a support for the back support. When retracting, you need to press the button on the left side of the folding foot downward to retract the foot.

### STEP14

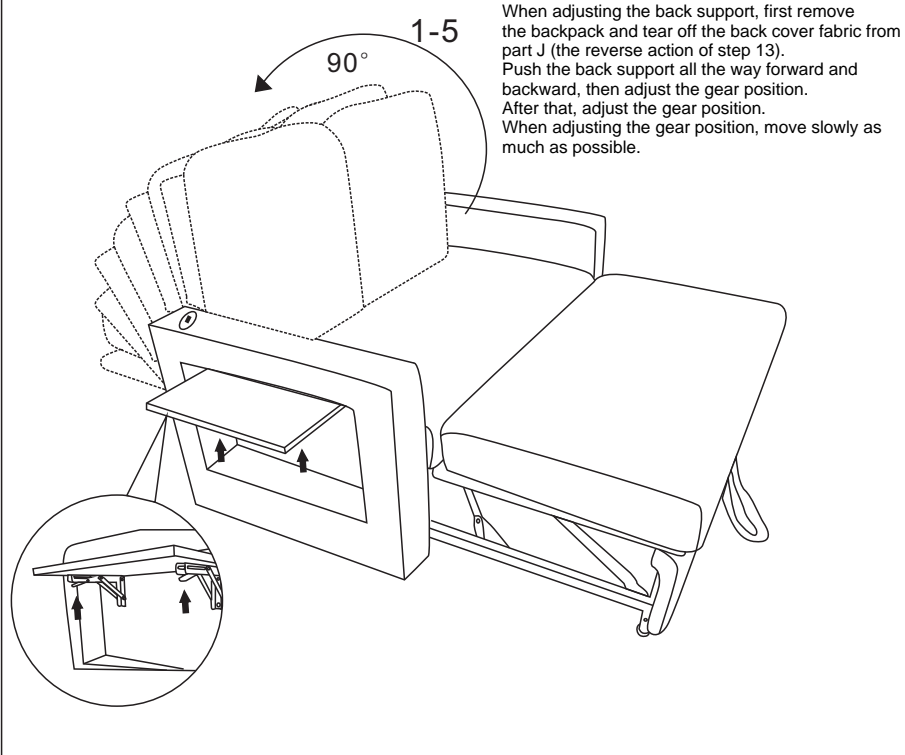

When adjusting the back support, first remove the backpack and tear off the back cover fabric from part J (the reverse action of step 13). Push the back support all the way forward and backward, then adjust the gear position. After that, adjust the gear position. When adjusting the gear position, move slowly as much as possible.

STEP15

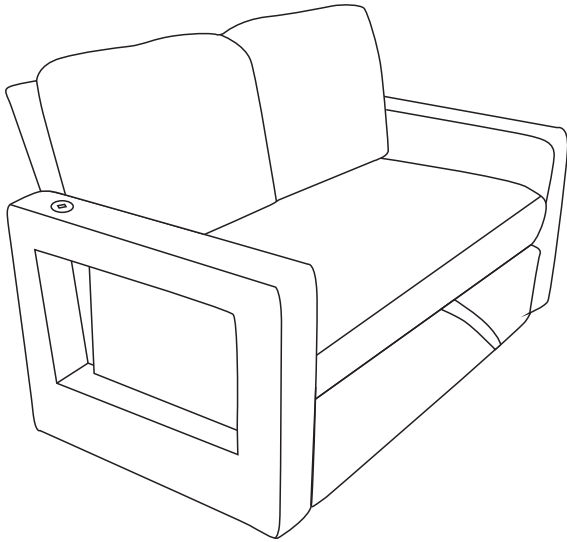

**COMPLETE!**