

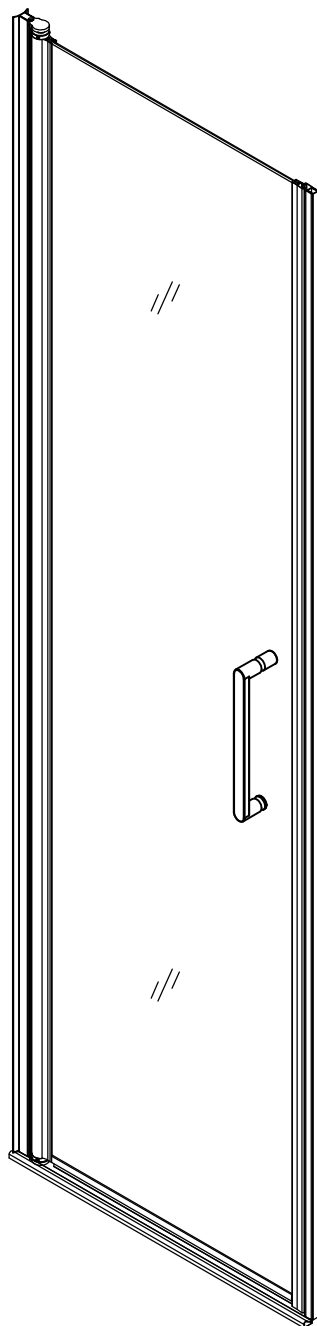

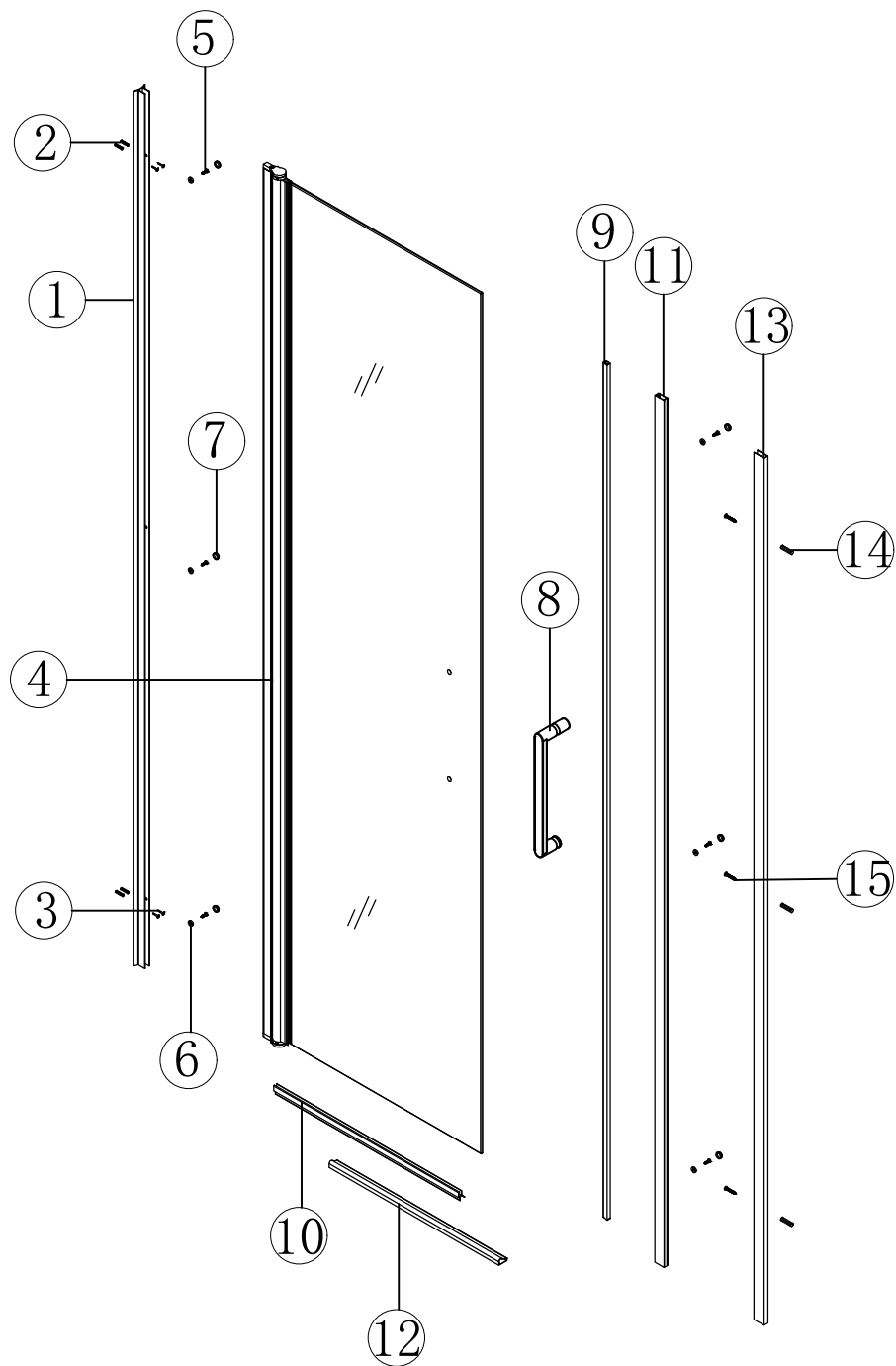









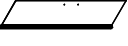

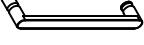

INSTALLATION MANUAL



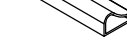

NO.	NAME	PICTURE	Qty
1	Pivot Wall Plate		1
2	8mm Wall Plug		4
3	ST5*40		4
4	Pivot Assembly		1
5	ST4*10		6
6	Screw Cover Base		6
7	Screw Cover Cap		6
8	Handle		1

NO.	NAME	PICTURE	Qty
9	Magnetic Seal Strip		1
10	Bottom Water Seal		1
11	Magnetic Strip		1
12	Water Guard Aluminum Profile		1
13	Magnetic Wall Strip		1
14	6mm Wall Plug		3
15	ST4*35		3

TOOLS REQUIRED (NOT SUPPLIED)

-When you're ready to start, make sure that you have the following tools to hand,

plenty of space and a clean dry area for assembly.

Two people are needed. Please note: although these instructions are comprehensive, we always recommend that a technically competent installer should undertake installation.

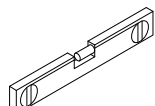

Spirit Level

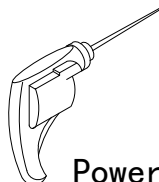

Power Drill

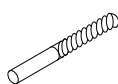

Ø3 Drill Bit

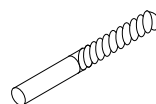

Ø6 Drill Bit



Silicone Sealant

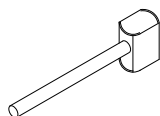

Rubber hammer



Tape measure

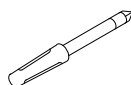

Screw driver



Pencil

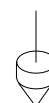

Hanging Hammer

PRE-INSTALLATION AND TECHNICAL REQUIREMENTS

- All dimensions are shown in millimeters, except where otherwise indicated.

-Ensure that the enclosure set is fitted to a level floor and vertical wall surface.

Please note: The wall fixings included with this product are suitable for solid walls only.

Plasterboard or stud walls may require specialist fixings (not supplied).

IMPORTANT SAFETY NOTES

- Please handle all glass with care, avoiding knocks and shock loading to all sides and edges.

Safety glass cannot be reworked.

- Care should be taken when drilling into walls to avoid hidden pipes or electrical cables.

AFTERCARE INSTRUCTIONS

- Soap and water will be adequate to clean the glass - a glass cleaner can be used if required.

- In hard water districts, insoluble lime salts may be deposited on the glass. If this deposit is allowed to build up it becomes increasingly difficult to remove and looks unsightly. Regular cleaning will minimise this effect.

