

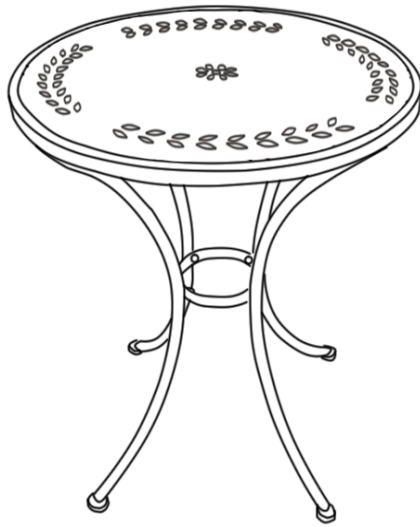



Assembly Instructions

Caution : You must read this before you proceed

Table



Parts List

Label	Picture	Description	QTY
A		Table Top	1
B		Table Leg (pre-installed Leveller)	4
C		Support Ring	1

Hardware

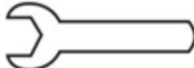
Label	Picture	Description	QTY
①		Nut	13
②		Spanner	1

Assembly Preparation

Before Beginning Assembly:

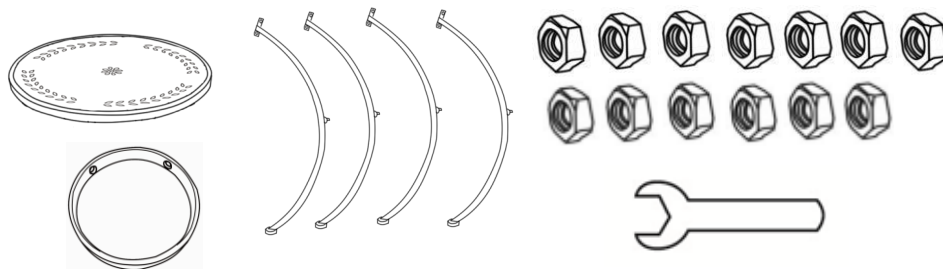

- Read instructions, cover to cover-



- Have 2 adults on hand for assembly-



- Do not assemble on flooring or carpet-



- Assemble on a clean non-marring surface (packing foam)-



- Save all packaging until finished-

Assembly Steps

Overview

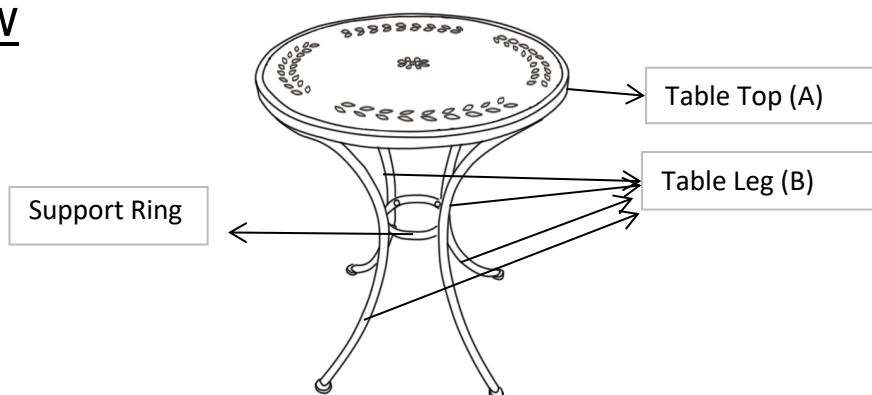

This Table has multiple parts and may require up to some 20 minutes to assemble. To give you an overview of the Table parts, the above picture is to help you put the various parts into perspective. Please read through the instructions herebelow to familiarise the parts and steps before assembly.

Step 1

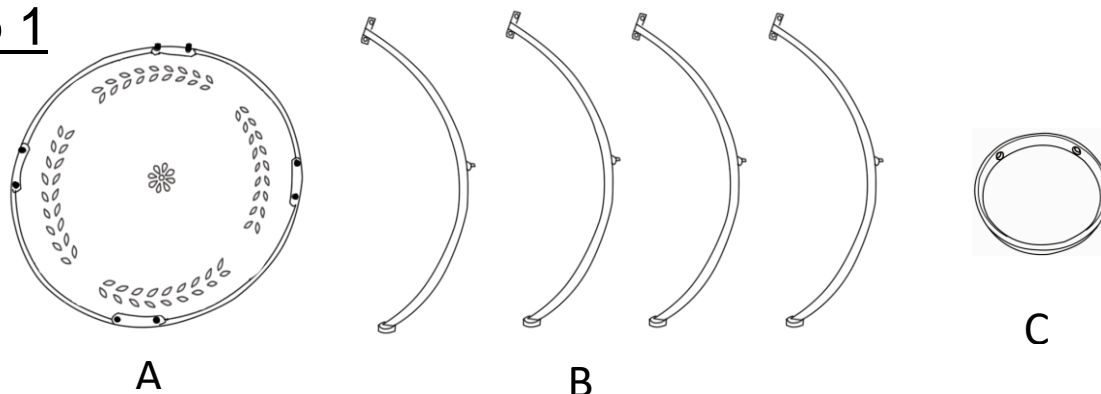

Unpack and place all parts on a clean, non-marring surface.

Step 2

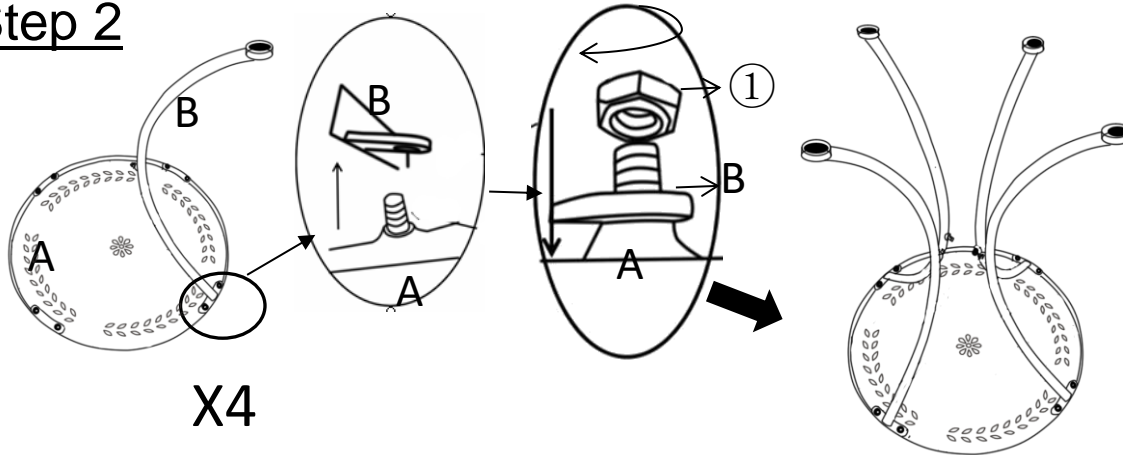

Lay the Table Top(A) facedown, onto a clean, non-marring surface.
Attach one of the Table Legs(B) to the the Table Top(A) using Nuts(D) with Spanner(2).
Repeat this method to assemble the remaining of 3 table legs.
Loosely tighten Nuts (D).

Step 3

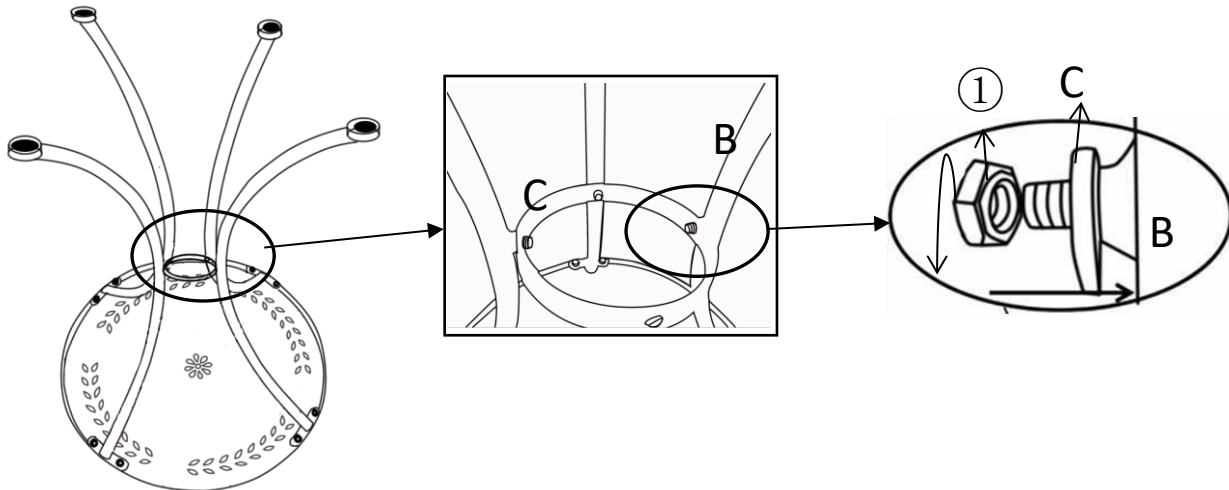

Attach the Support Ring(C) to Table Legs(B) using Nuts(1) with Spanner(2).
Loosely tighten Nuts.

Step 4

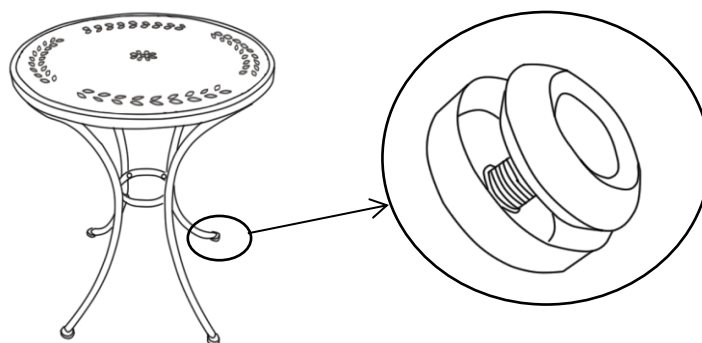









Stand the Table and test for wobbleness.
Upon checking there is no wobbles, lay down the table and proceed to fully tighten all bolts.
Tighten all Nuts, in a sequential manner.
Stand the Table up.
Adjust the Legs pre-installed Levellers until the table is level to the ground.

Step 5



Your Table is now ready for use.

Care & Maintenance

-  Do not put hot items directly on furniture surface
 -  Do not clean furniture with harsh cleansers or polish.
 -  To obtain the longest lifespan of your outdoor products, minimizing exposure to direct sunlight is recommended.
 -  Children should not climb or jump on the furniture.
 -  Do not write on furniture without a padded barrier to protect the surface.
 -  To obtain the longest lifespan of your outdoor products, avoid extended and lengthy exposure to rain, snow, and direct sunshine. Whenever possible cover the product and /or place under patio or awnings.
 -  Not for commercial use. For residential use only .
 -  Stains may be removed with mild soap solution and damp cloth.
-
-  Dust and pick-up spills using a clean, non-colored, lint-free cloth .