

**ASSEMBLY INSTRUCTIONS-PLEASE KEEP FOR FUTURE REFERENCE**



**Important-please read these instructions fully before starting assembly**

# Safety and Care Advice

**Important** – Please read these instructions fully before starting assembly

- Check you have all the components and tools listed on pages 2 and 3.
- Remove all fittings from the plastic bags and separate them into their groups.
- Keep children and animals away from the work area, small parts could choke if swallowed.
- Make sure you have enough space to layout the parts before starting.

- Do not stand or put weight on the product during assembly, this could cause damage.
- Assemble the item as close to its final position (in the same room) as possible.
- Assemble on a soft level surface to avoid damaging the unit or your floor.
- Parts of the assembly will be easier with 2 people.



- We do not recommend the use of power drill/drivers **for inserting screws**, as this could damage the unit. Only use hand screwdrivers.
- Dispose of all packaging carefully and responsibly.

## Care and maintenance

- Only clean using a damp cloth and mild detergent, do not use bleach or abrasive cleaners.
- From time to time check that there are no loose screws on this unit.

- Do not stand on the chair.
- Do not use this chair as step ladder.
- This product should not be discarded with household

waste. Take to your local authority waste disposal centre.

## Handy Hints

- Assemble all parts and bolts loosely during assembly, only once the product is complete should you fully tighten the bolts.
- Regularly check and ensure that all bolts and fittings are tightened properly.

# Components - Parts

Please check you have all the parts listed below

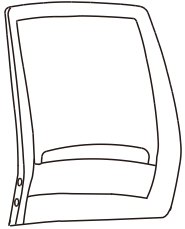

**1** Backrest x1

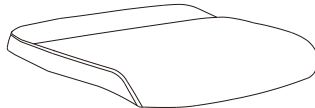

**2** Seat x 1

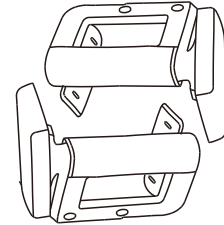

**3** Left armrest x1 & Right armrest x 1

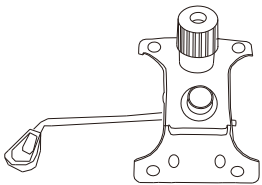

**4** Seat plate x 1



**5** Gas lift x 1

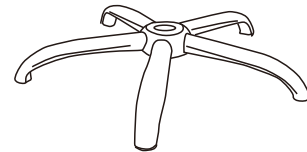

**6** Base x 1

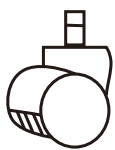

**7** Castors x 5

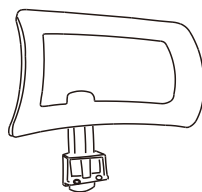

**8** Headrest X 1

# Components - Fittings

Please check you have all the fittings listed below.

**Note:** The quantities below are the correct amount to complete the assembly.  
In some cases more fittings may be supplied than are required.

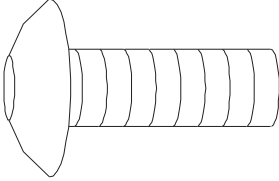
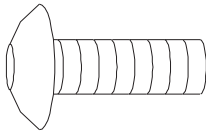
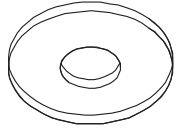
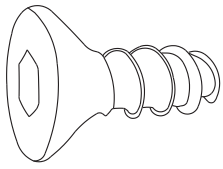
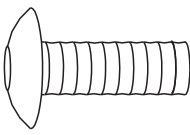
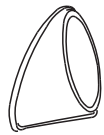
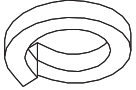
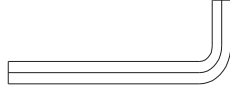
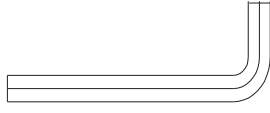
<p><b>A</b></p>  <p>M6*35MM / 2PCS</p>	<p><b>B</b></p>  <p>M6*30MM / 2PCS</p>	<p><b>C</b></p>  <p>Φ6*18*1MM / 12PCS</p>
<p><b>D</b></p>  <p>M5*20MM / 2PCS</p>	<p><b>E</b></p>  <p>M6*35MM / 8PCS</p>	<p><b>F</b></p>  <p>Plastic cover / 4PCS</p>
<p><b>G</b></p>  <p>M8* 8 PCS</p>	<p><b>H</b></p>  <p>M3 / 1PCS</p>	<p><b>I</b></p>  <p>M5 / 1PCS</p>

# Assembly Instructions

## Step 1

### Fitting the base

Push all the five castors **(7)** into the underside of the base **(6)**.

Insert the gas lift **(5)** into the base **(6)**.

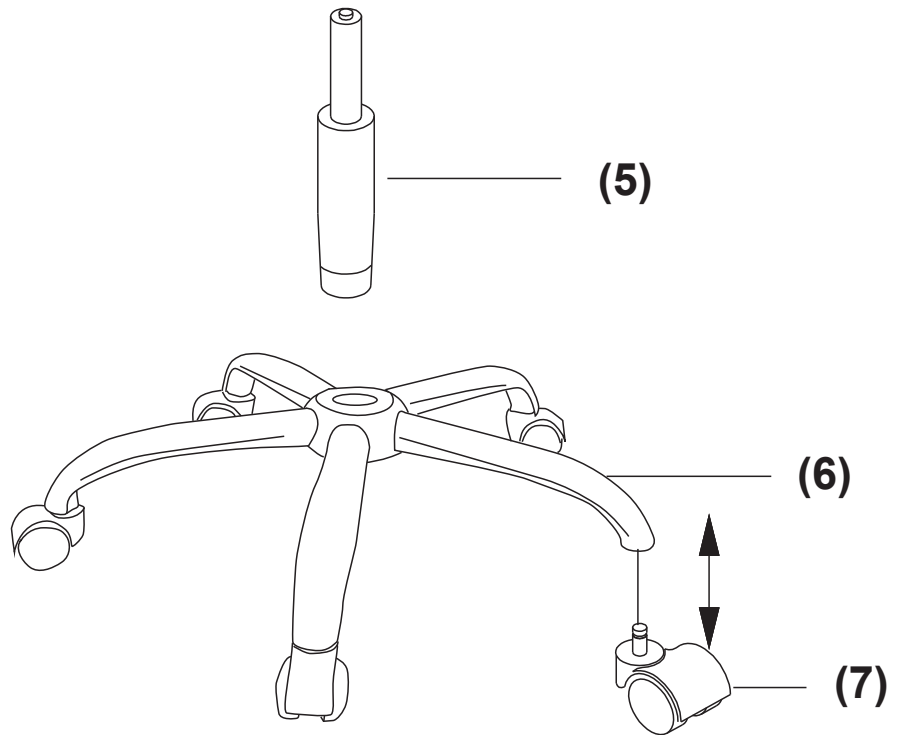

## Step 2

### Fitting the Armrests

Use bolts **(E)** and washer **(G)** and spring washer **(C)** to fix the arms **(3)** on the seat **(2)**.

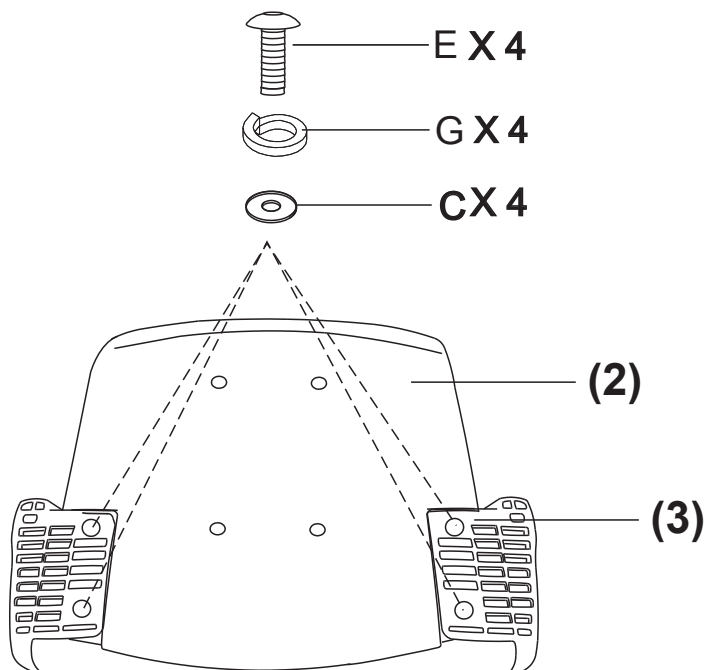

# Assembly Instructions

## Step 3

### Fitting the Seat Cushion

Use bolts **A** **B** and washer **C** and spring washer **G** to fix the seat plate **4** onto the seat **2**. Ensure the plate **4** is fitted to the seat with correct orientation.

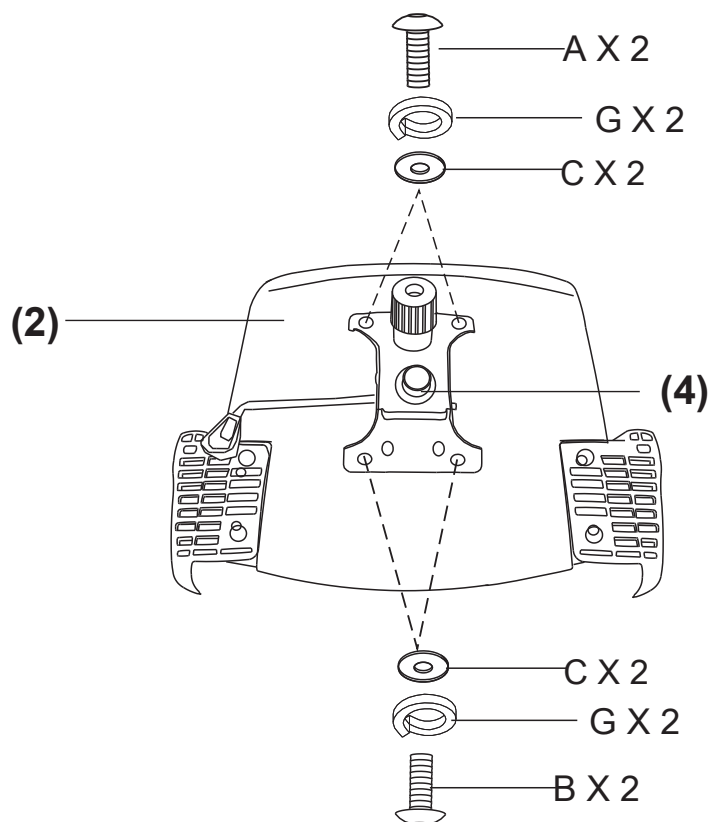

## Step 4

### Fitting the Armrests

Use bolts **E** and washer **C** to fix the arms **3** on the backrest **1**.

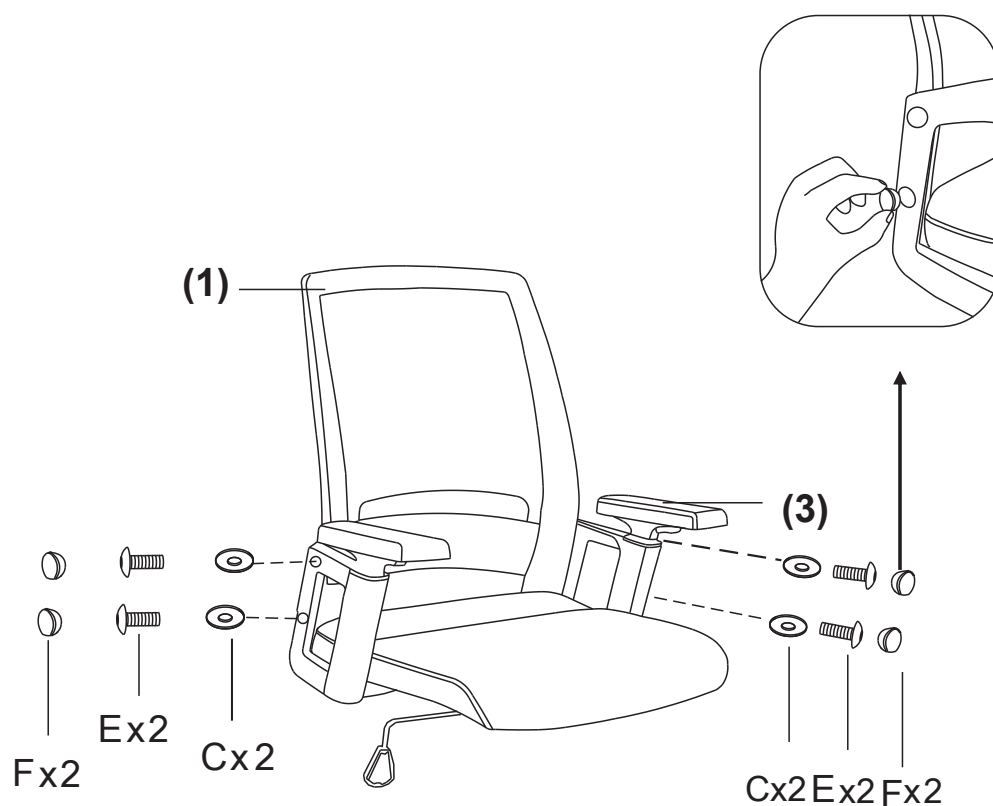

# Assembly Instructions

## Step 5

Carefully locate the seat **2** onto the base unit.

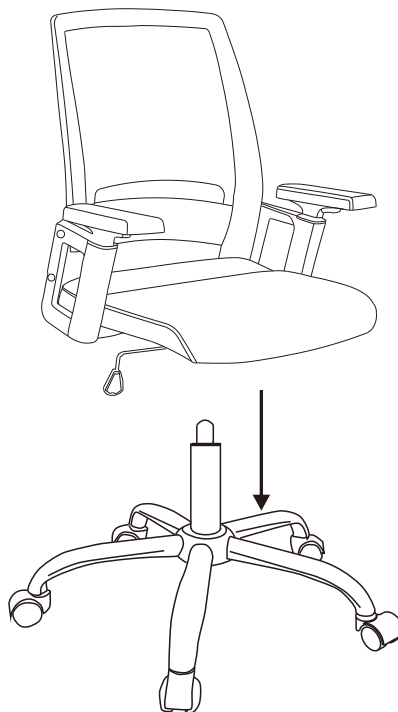

## Step 6

### Fitting the headrest

Use bolts **D** and Allen key **H** to fix the headrest **8** onto the backrest **1**

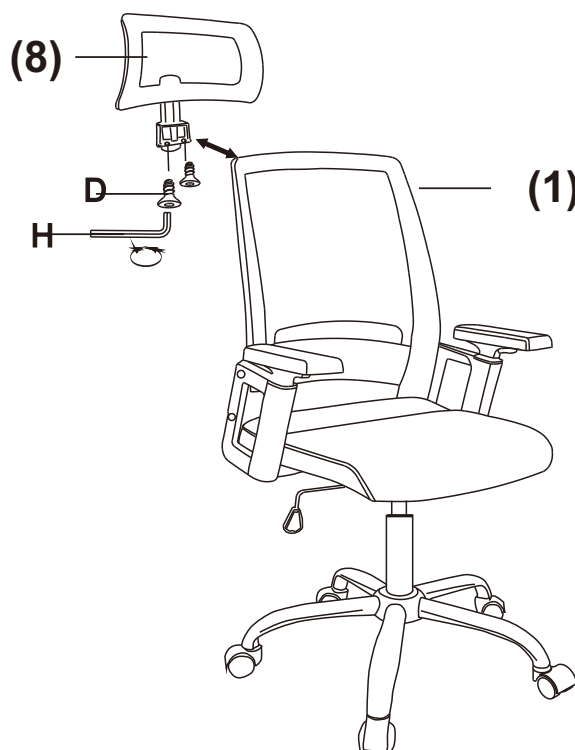

STEP1

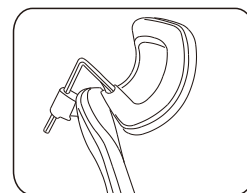

STEP2

