

ASSEMBLY INSTRUCTIONS



LOVESEAT

LOVESEAT

ASSEMBLY INSTRUCTIONS

ASSEMBLY TIPS:

1. Remove hardware from box and sort by size.
2. Please check to see that all hardware and parts are present prior to start of assembly.
3. Please follow attached instructions in the same sequence as numbered to assure fast and easy assembly.







WARNING!

1. Don't attempt to repair or modify parts that are broken or defective. Please contact the store immediately.
2. This product is for home use only and not intended for commercial establishments.

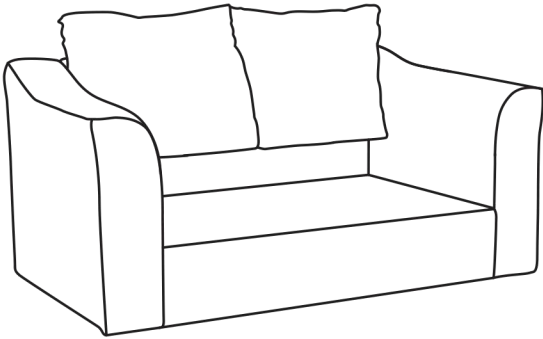

ASSEMBLY TIME
15
MINUTES

PARTS IDENTIFICATION

	PART NAME	FIGURE	QUANTITY
A	LOVESEAT BASE	 <p><i>Please note back cushions should already be attached to loveseat base.</i></p>	1 PC
B	SEAT CUSHION		2 PCS
C	ACCENT PILLOW		2 PCS
D	LEG		4 PCS

LOVESEAT

ASSEMBLY INSTRUCTIONS

STEP 1 *Install front and rear legs on underside of loveseat base.*

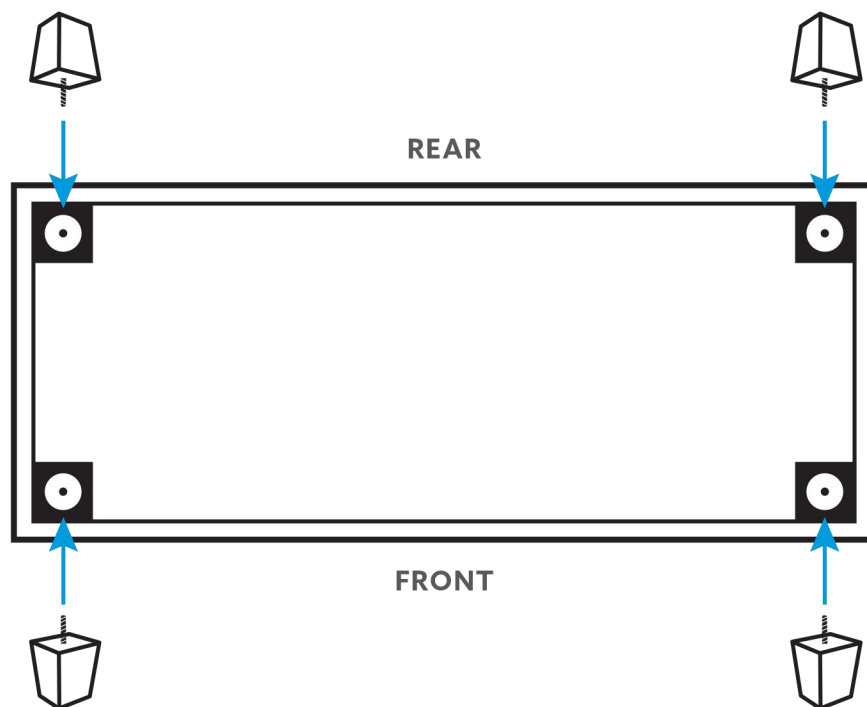

STEP 2 COMPLETE

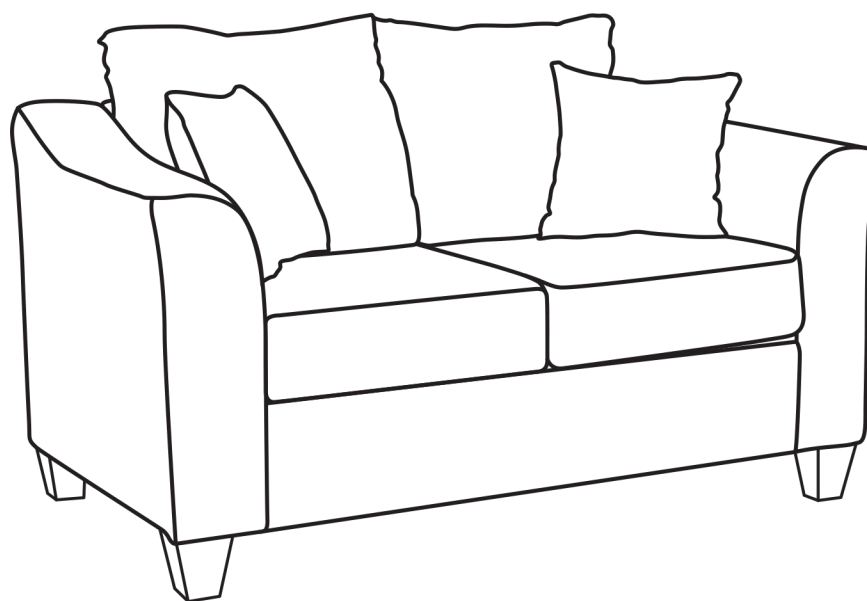

LOVESEAT

DIMENSIONS

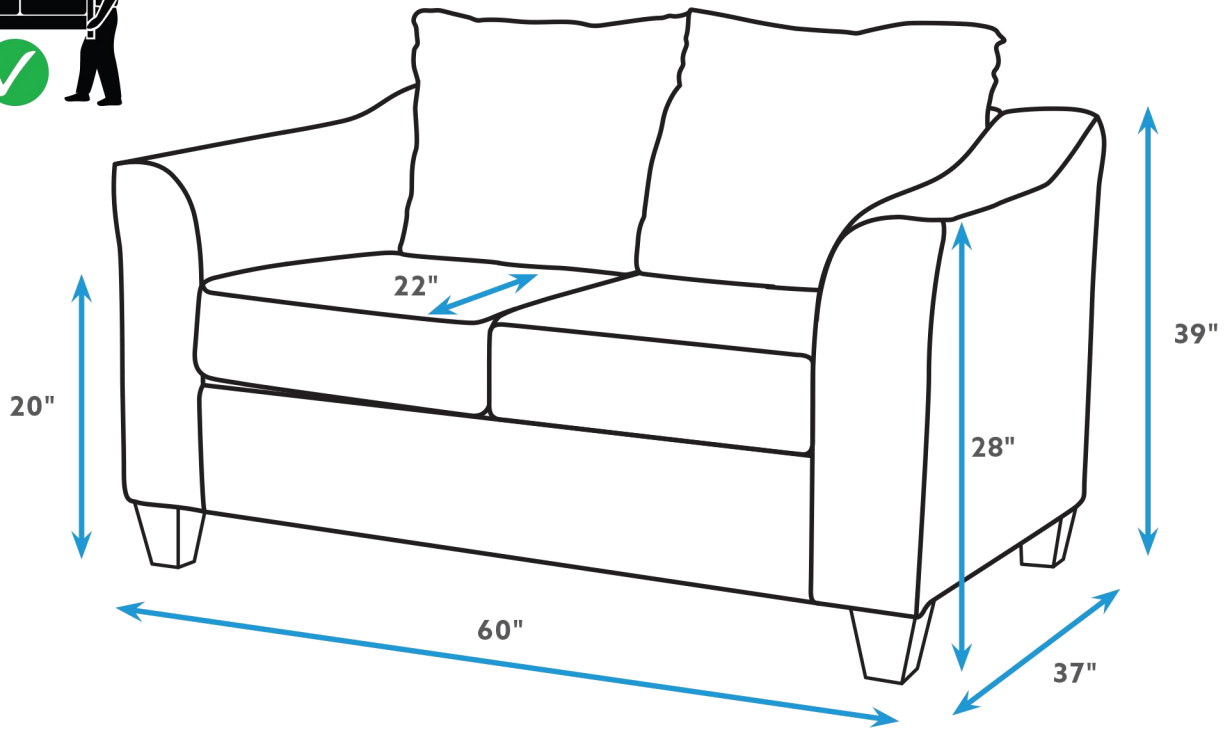

NOTE: Dimension tolerance $\pm 5\%$