

Toilet Storage Cabinet

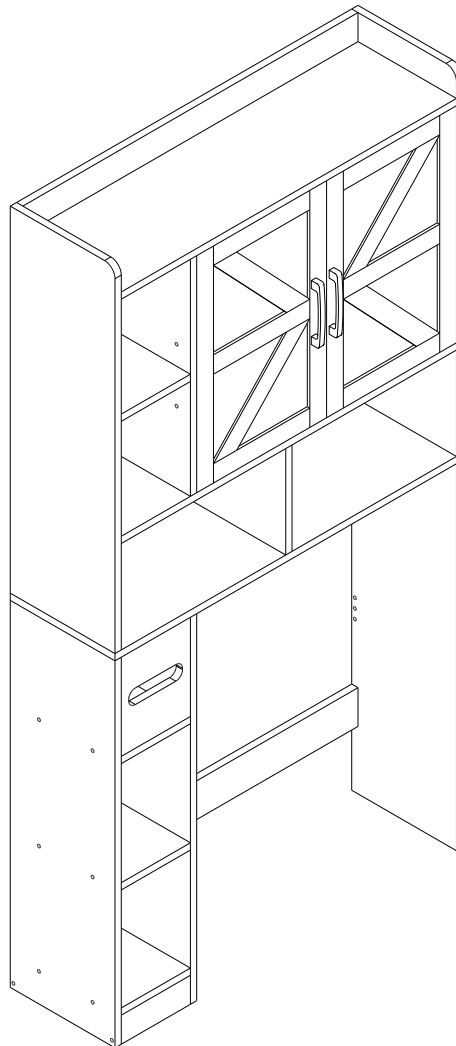















THIS INSTRUCTION BOOKLET CONTAINS IMPORTANT SAFETY INFORMATION. PLEASE READ AND KEEP FOR FUTURE REFERENCE.

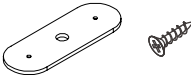
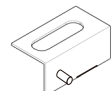
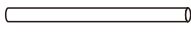
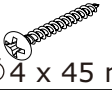

Before You Start

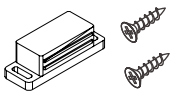
- ⚠ Please read all instructions carefully.
- ⚠ Retain instructions for future reference.
- ⚠ Separate and count all parts and hardware.
- ⚠ Read through each step carefully and follow the proper order.
- ⚠ We recommend that, where possible, all items are assembled near to the area in which they will be placed in use, to avoid moving the product unnecessarily once assembled.
- ⚠ Always place the product on a flat, steady and stable surface.
- ⚠ Keep all small parts and packaging materials for this product away from babies and children as they potentially pose a serious choking hazard.

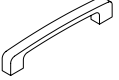
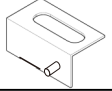
Hardware Provided

A	 Ø6 x 35 mm	28PCS	B	 Ø15 x 9 mm	28PCS
C	 Ø4 x 10 mm	8PCS	D		39PCS
E	 Ø4 x 14 mm	4PCS	F		2PCS
G	 Ø4 x 35 mm	28PCS	H		4PCS
I		3PCS	J		1PC
K		1PC	L	 Ø4 x 45 mm	2PCS
M		2PCS	N		8PCS
O		2PCS	P	 Ø4 x 12 mm	24PCS
Q		2PCS	R		1PC
S		12PCS			

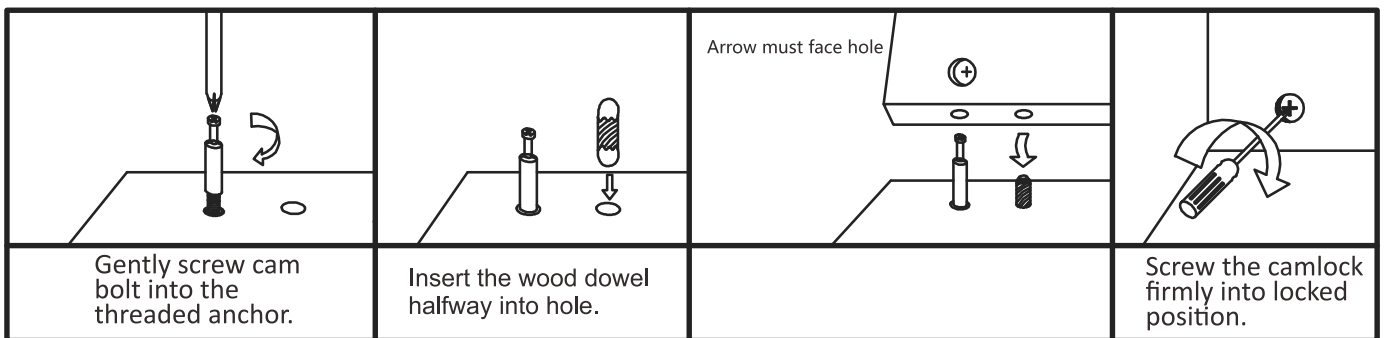

WARRANTY

1-YEAR LIMITED WARRANTY











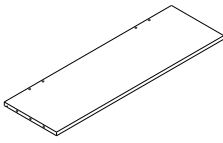
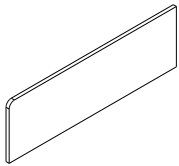

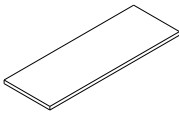
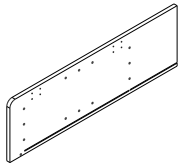
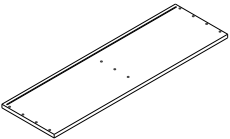
This product carries a 1 year warranty against defects in workmanship and materials. agrees to replace the defective product free of charge within the stated warranty period. IF you can provide the purchase proof of your original order

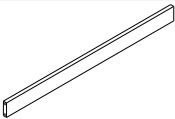
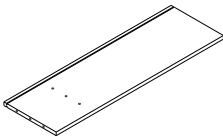
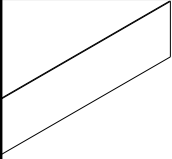
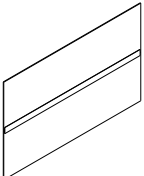
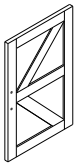
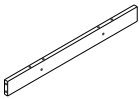
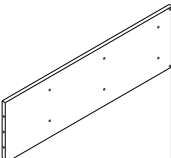
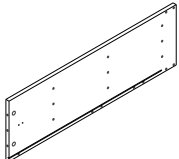
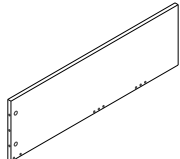
This product is not guaranteed against wear or breakage due to misuse or abuse.

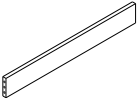
CARING FOR YOUR ITEM

Wipe clean with a damp cloth. Do not use solvent-type cleaning agents. Do not use bleach, acid or other abrasive cleaners.

Parts Identification

①	②	③	④	⑤	⑥
					
1PC	1PC	1PC	1PC	1PC	1PC
⑦	⑧	⑨	⑩	⑪	⑫
					
1PC	1PC	1PC	1PC	1PC	1PC
⑬	⑮	⑭	⑰	⑱	⑲
					
1PC	1PC	1PC	1PC	1PC	1PC
⑳	㉑	㉒	㉓	㉔	㉕
					
1PC	1PC	1PC	1PC	2PCS	1PC

WARRANTY

1-YEAR LIMITED WARRANTY

This product carries a 1 year warranty against defects in workmanship and materials. agrees to replace the defective product free of charge within the stated warranty period. IF you can provide the purchase proof of your original order



This product is not guaranteed against wear or breakage due to misuse or abuse.

CARING FOR YOUR ITEM

Wipe clean with a damp cloth. Do not use solvent-type cleaning agents. Do not use bleach, acid or other abrasive cleaners.

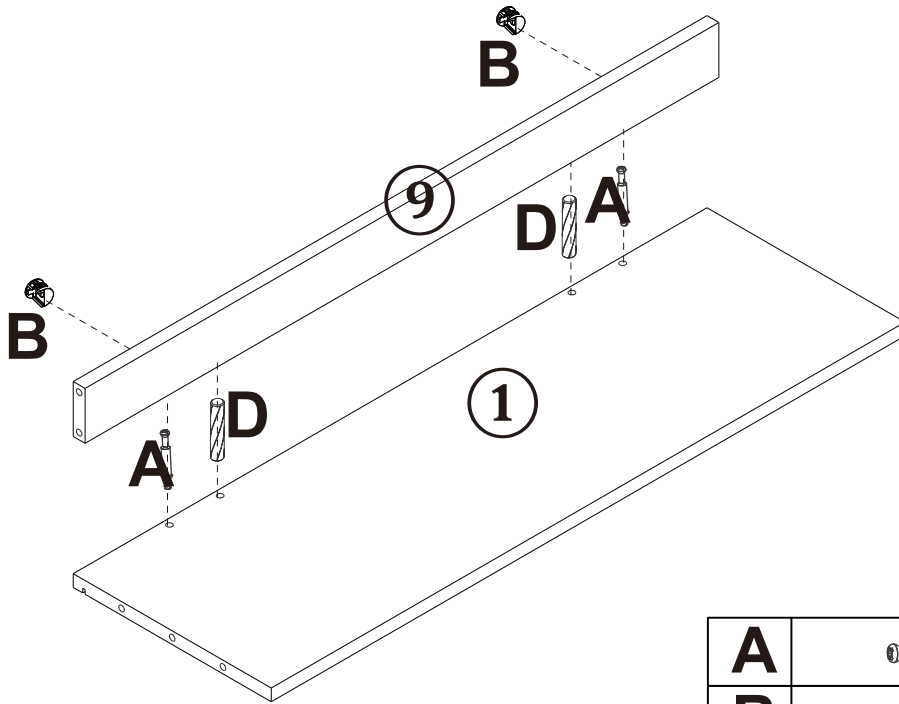

1

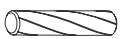

A		x2
B		x2
D		x2

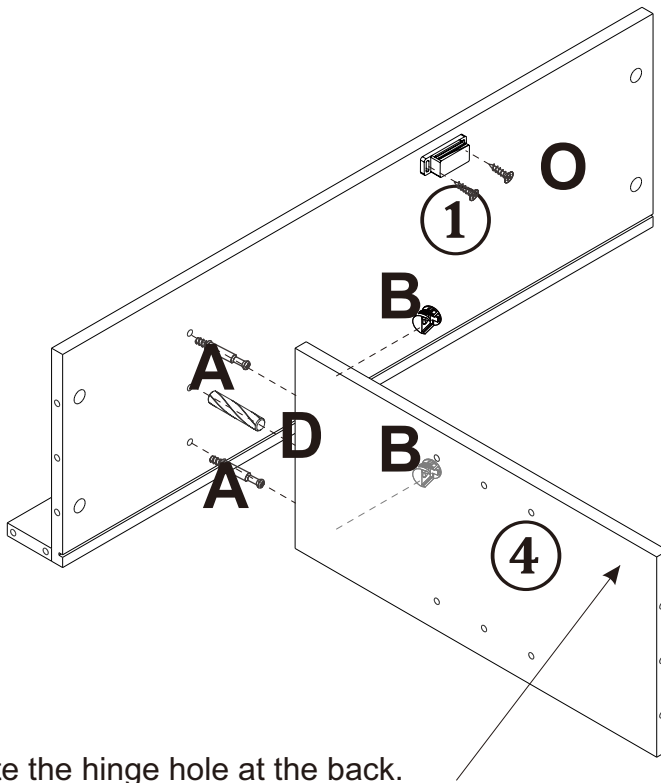
2

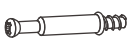

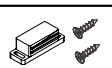

A		x2
B		x2
D		x1
O		x1



Please note the hinge hole at the back.

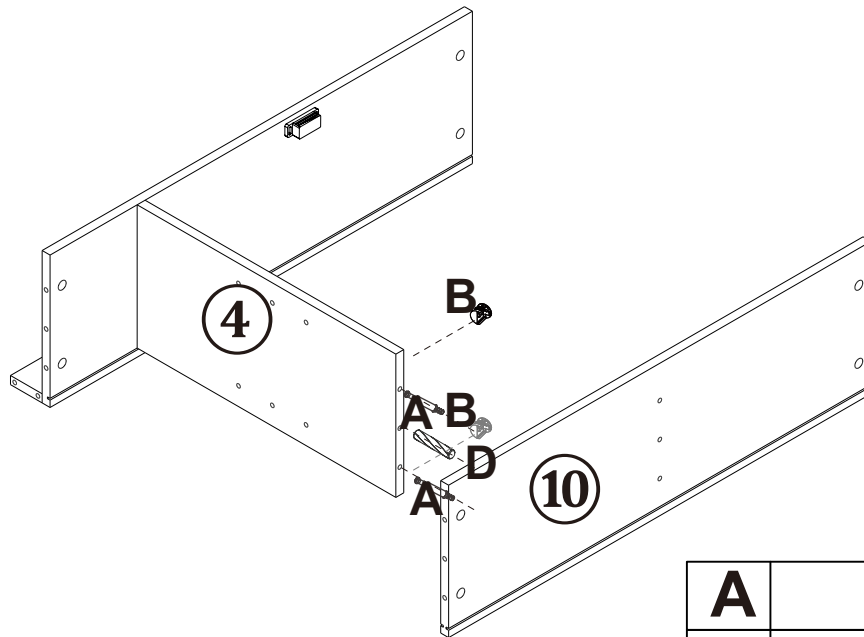

3

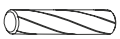

A		x2
B		x2
D		x1

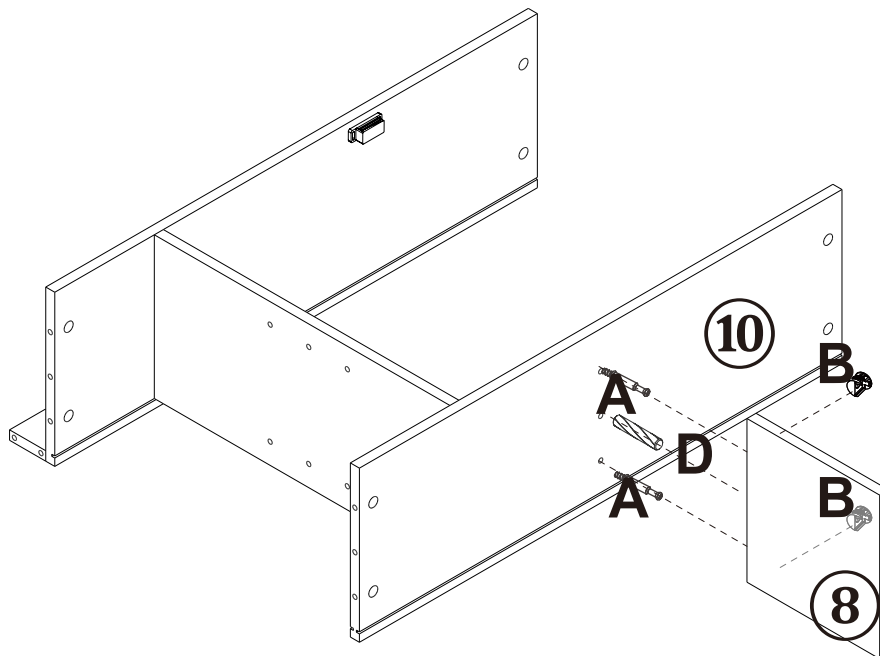

4

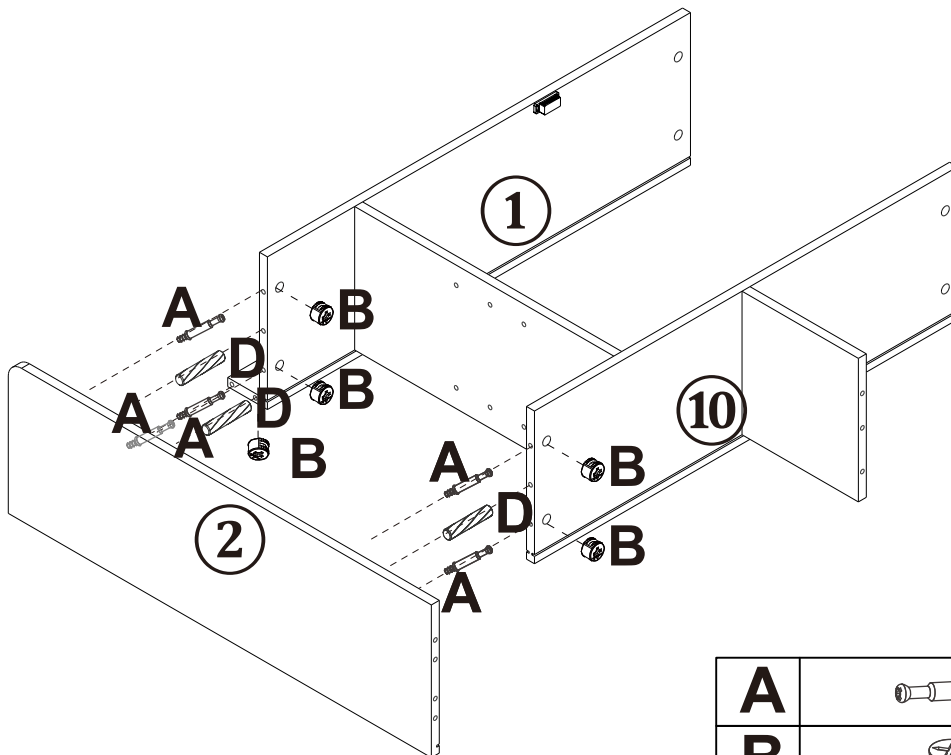

A		x2
B		x2
D		x1

5

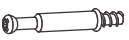

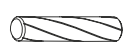
A		x5
B		x5
D		x3

6

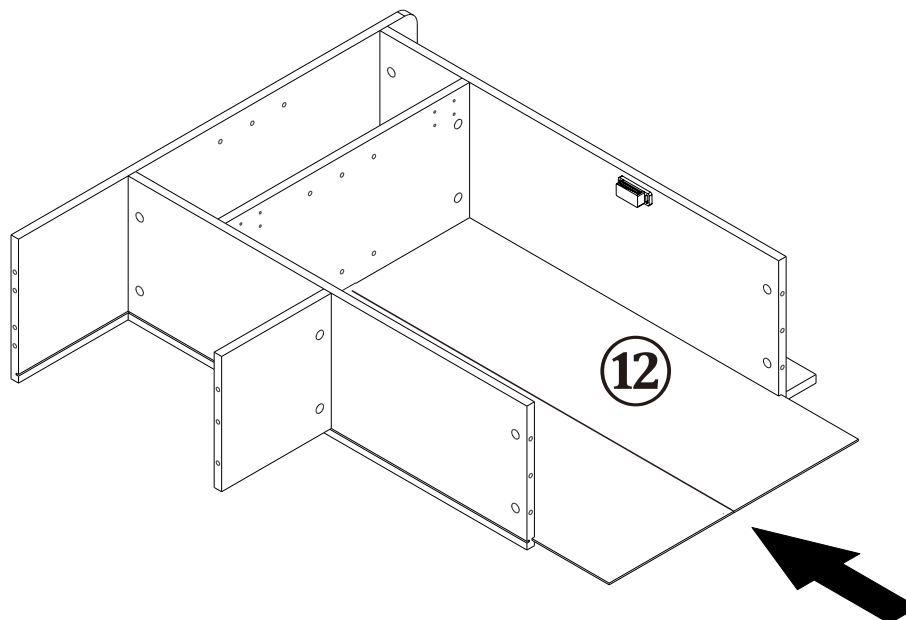

7

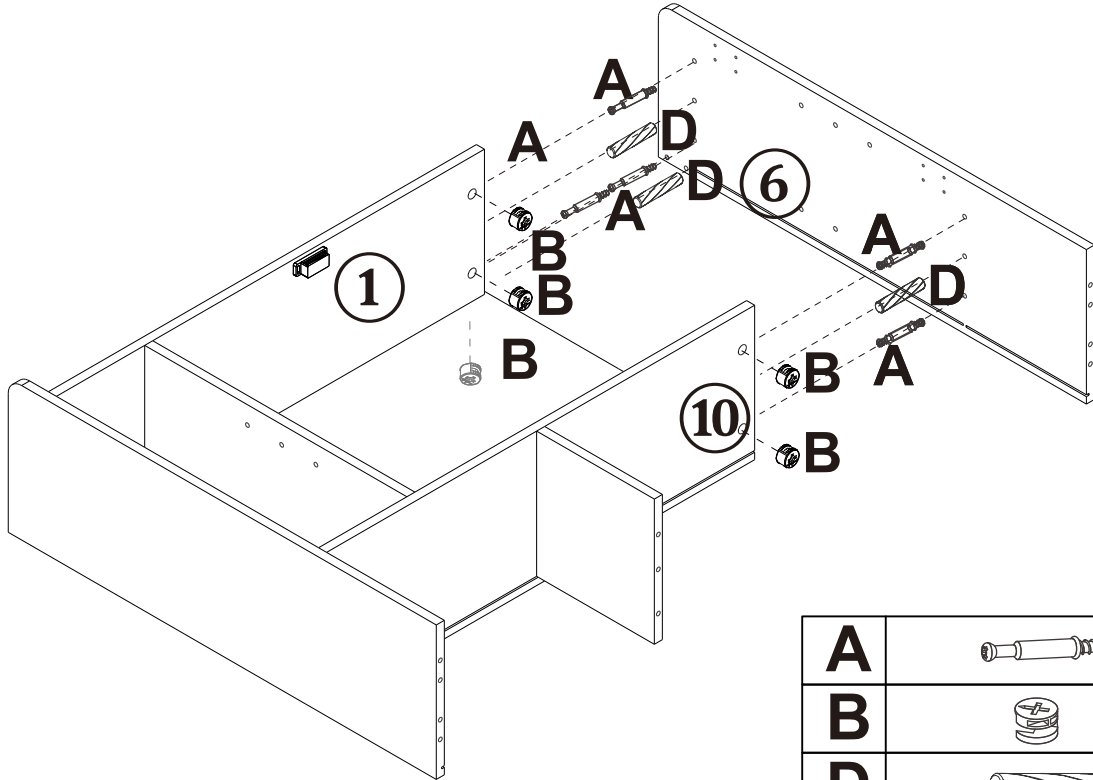

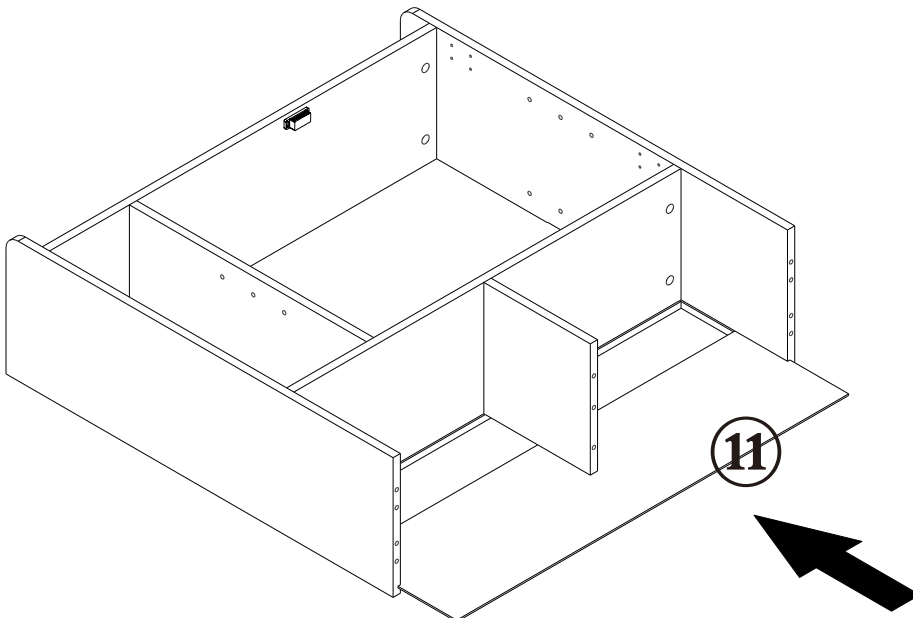

8



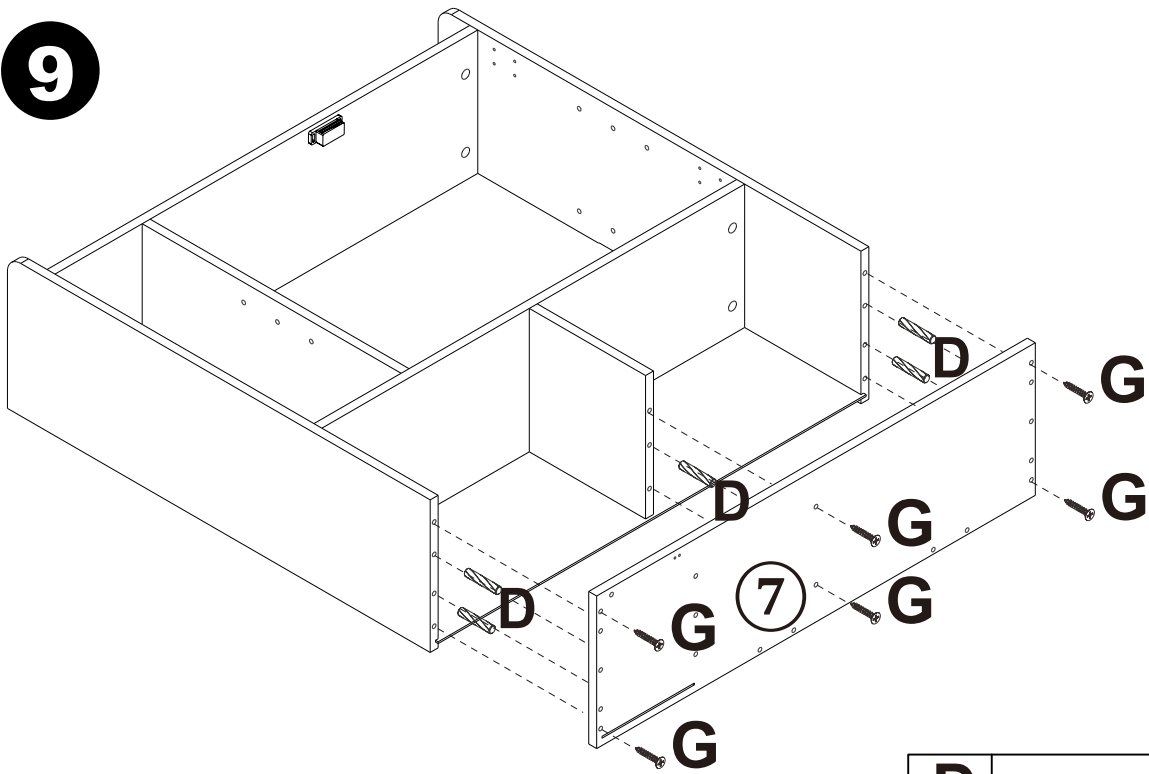

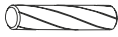
9

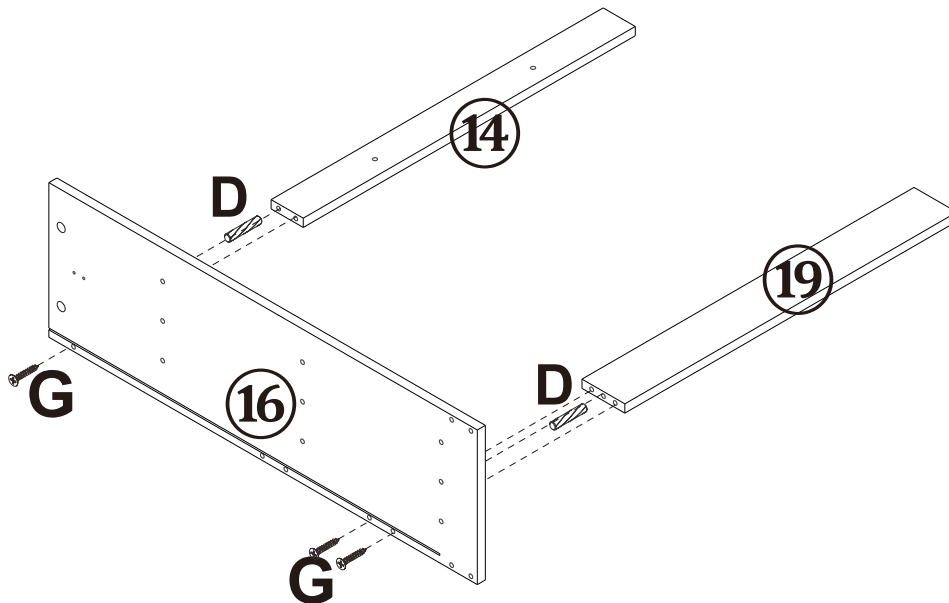

D		x5
G		x6

10

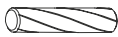



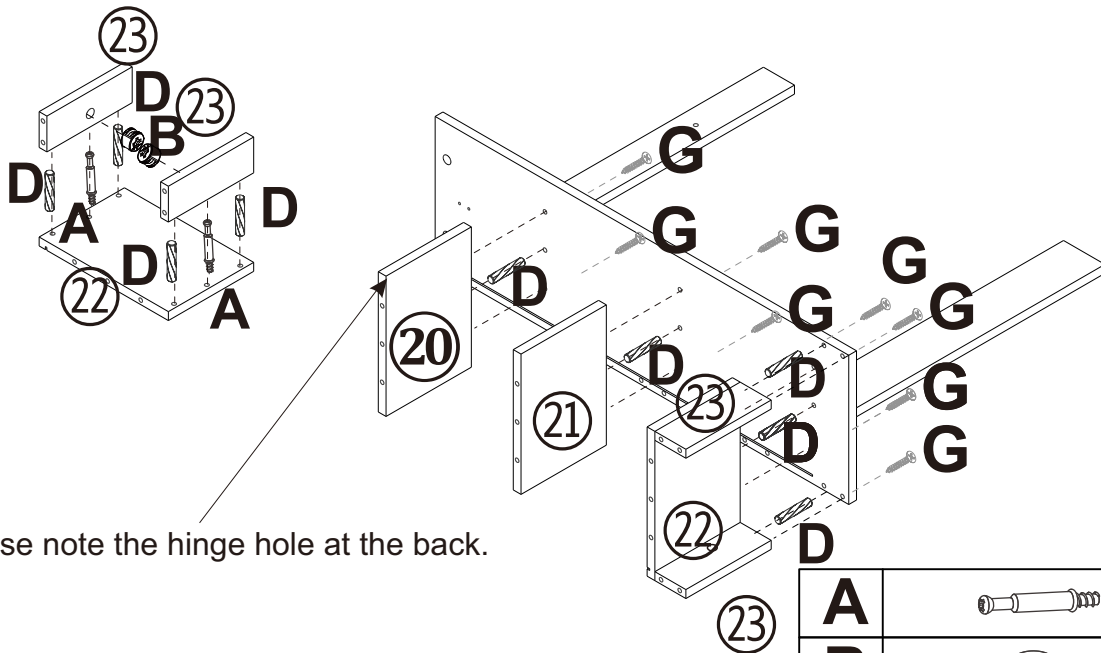

D		x2
G		x3

11



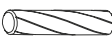

! Please note the hinge hole at the back.

A		x2
B		x2
D		x9
G		x8

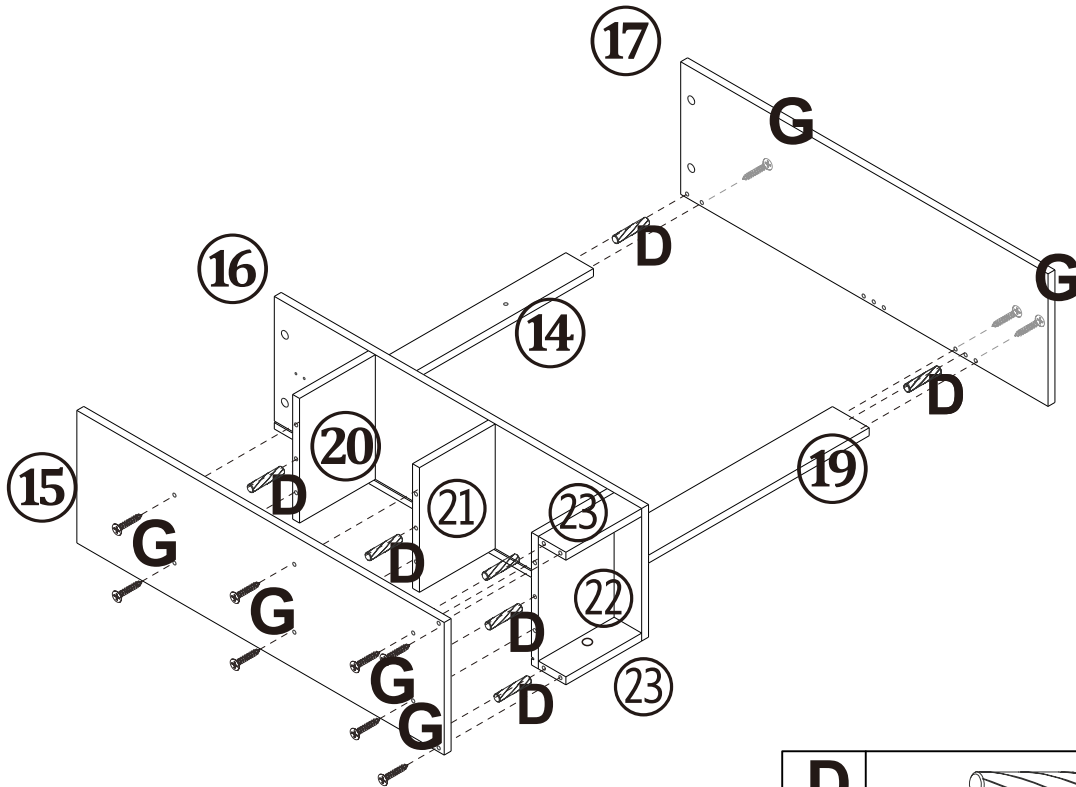

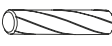
12



D		x7
G		x11

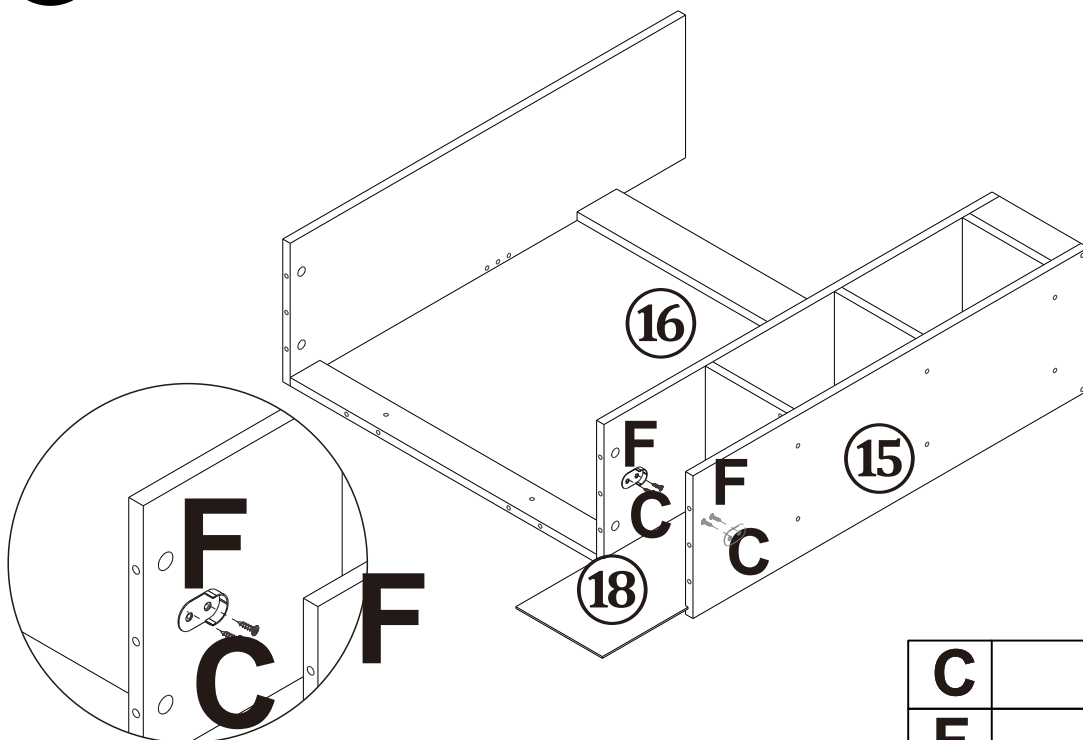



13

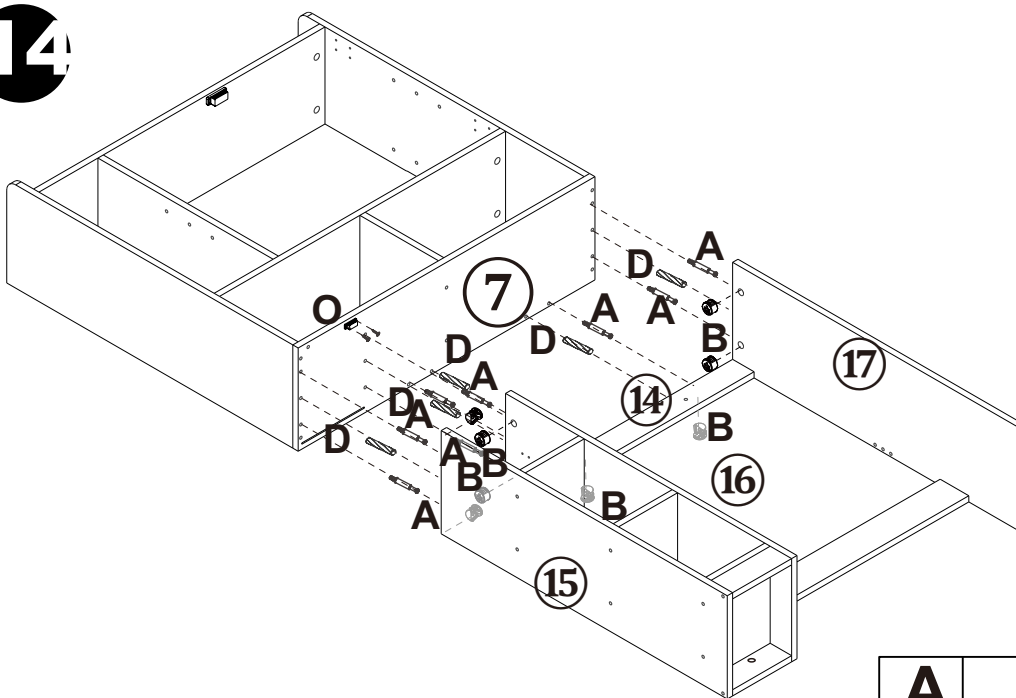

C		x4
F		x2



14



A		x8
B		x8
D		x5
O		x1

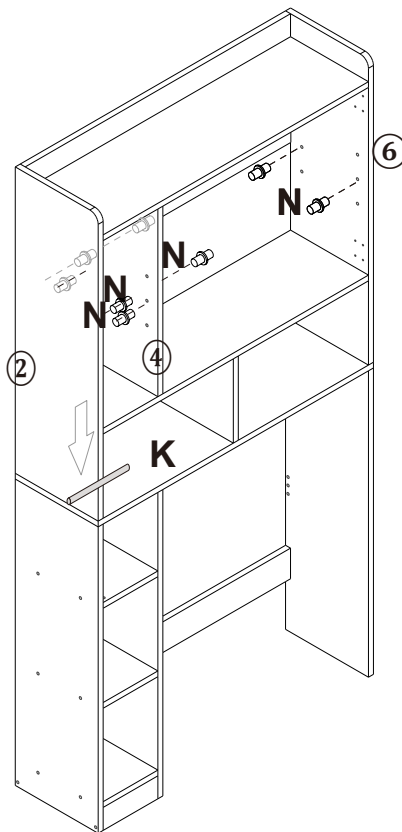

15

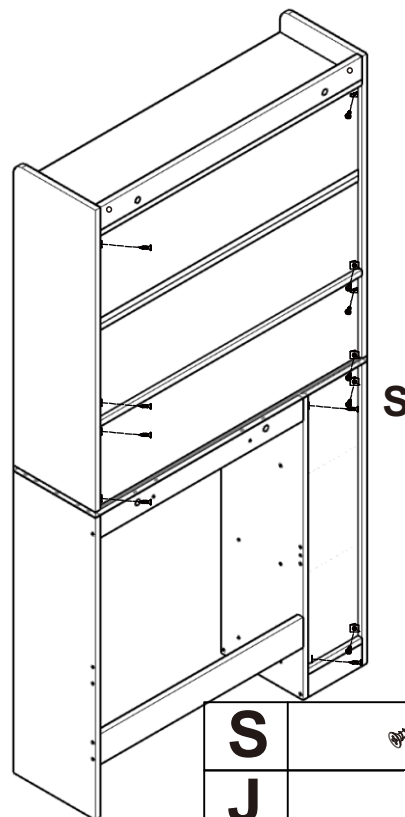
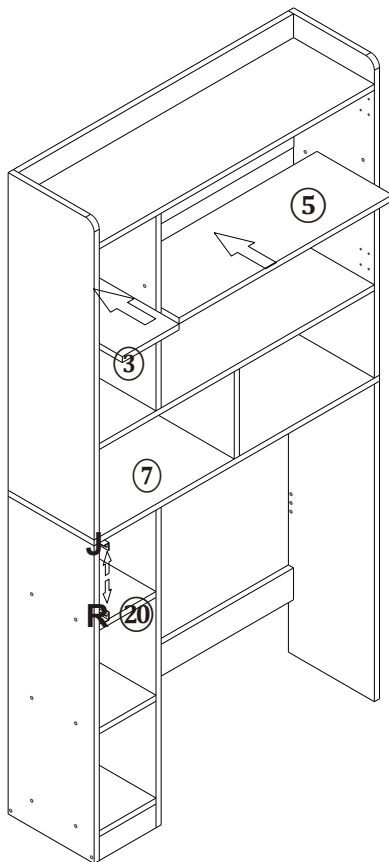

K		x1
N		x8

16



S		x12
J		x1
R		x1

17

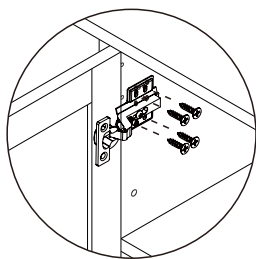

13

24

25

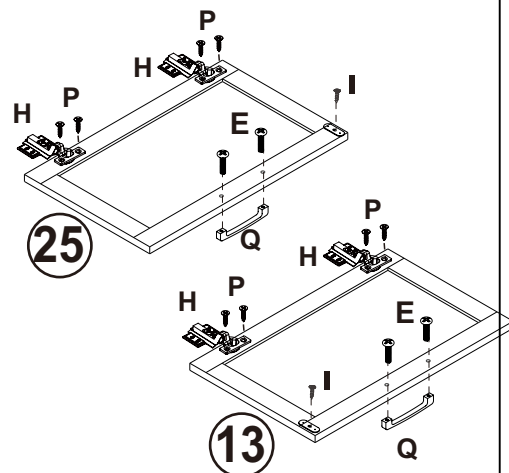
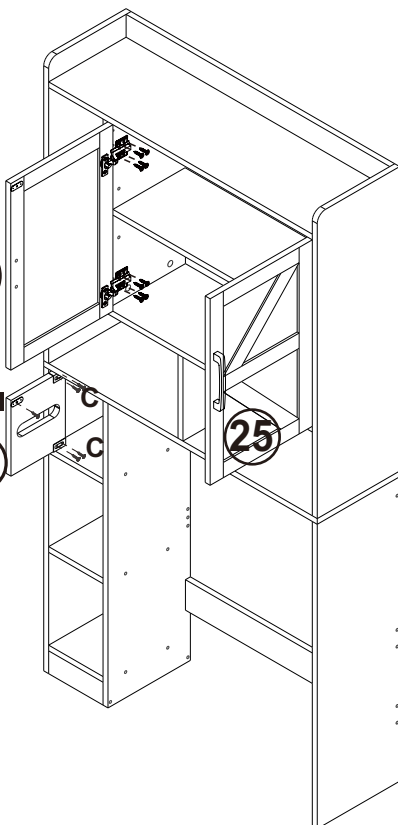

C		x4
I		x3
H		x4
P		x24
Q		x2
E		x4

18

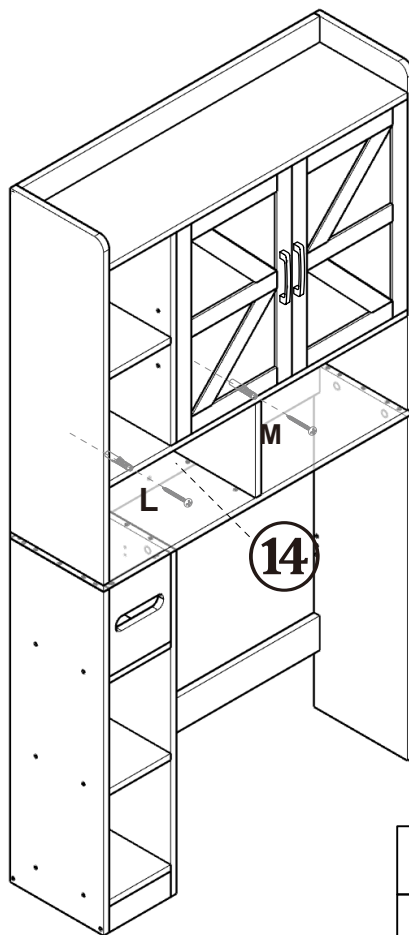
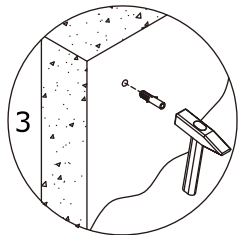
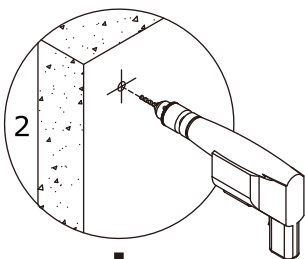
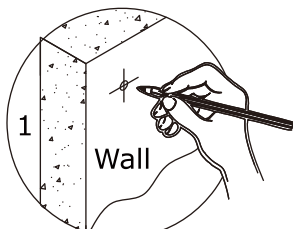

L		x2
M		x2

The ways to adjust the door

- Before adjusting the hinge, please check whether the cabinet is skewed.
- If the skew can not be repaired, please remove the anti-tipping device first, then adjust the cabinet to vertical position.
- Please adjust the hinge with the door open.
- Please operate it with more than 2 people, one person holds the door and the other one adjusts the screw.

Components Name

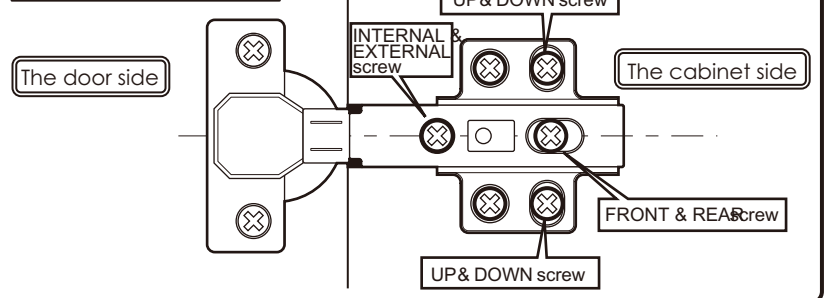

Obvious gaps between doors or Doors don't look closed

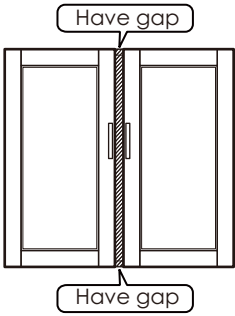

- 1 Turn "internal & external screw" to the right can make the door approach inside. Please adjust the doors little by little.

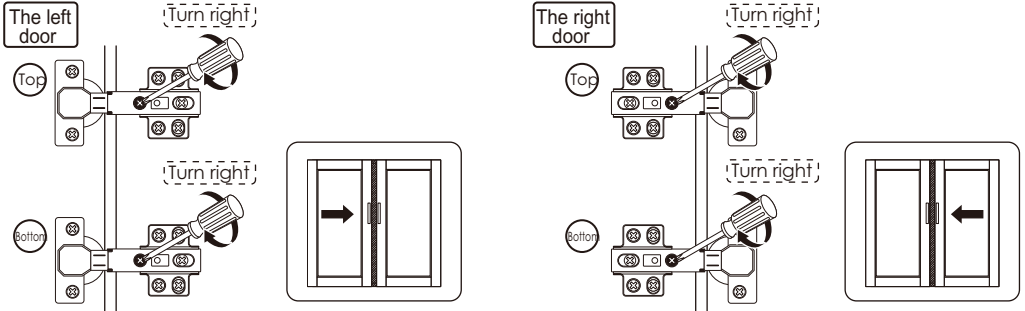

※ If the 2 doors are overlap, please turn the "internal & external screw" to the left.

When door is crooked



Please take the following steps to adjust first.

- 1 Rotate the "front and rear screws" to the left

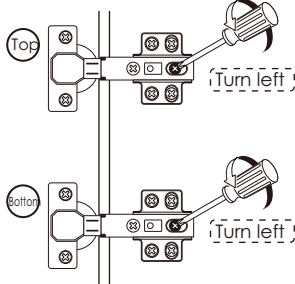

※ After adjusting the "front and rear screw", the door still does not change, please turn the "internal & external screw" to the right slightly.

- 2 Push the door to the cabinet

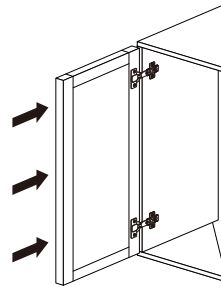

- 3 Rotate the "front and rear screws" to the right

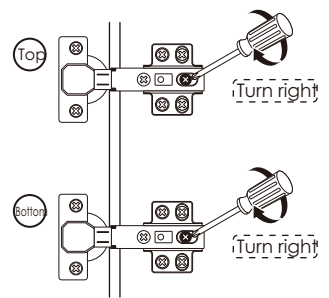

When door is leaning

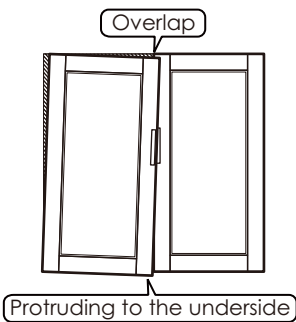

- 1 Turn "internal & external screw" to the left can make the top of the door tilted outward.

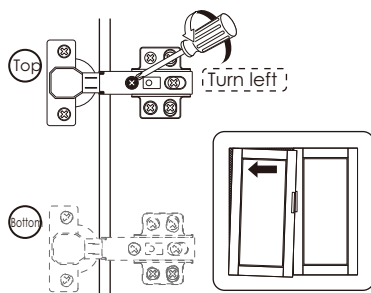

Protruding to the upside



- 1 Turn "internal & external screw" to the left can make the bottom of the door tilted outward.

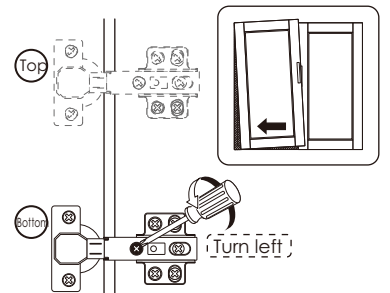

When the door is higher on top

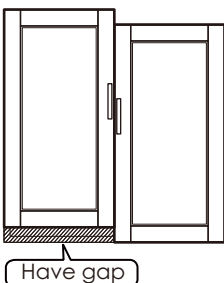

- 1 Turn "up & down screw" to the left

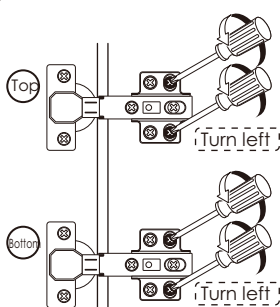

- 2 Lower the door's height so that 2 doors are of the same height.

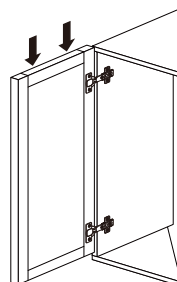

- 3 Turn "up & down screw" to the right

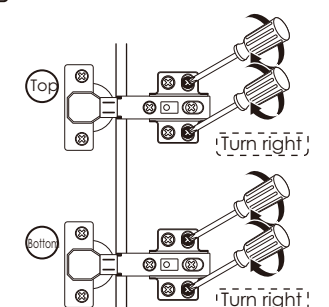

※ If the door is lower on bottom, please lift up the left door slightly on step 2