

Installation Instructions



Professional lamp manufacturer

STURDY • CHARMING • DURABLE

chandelier

CATALOG

Cleaning Method & Maintenance page 2

Safety Information page 3-6

Parts Including page 7-8

Installation Steps page 9-10

✦ CLEANING METHOD & MAINTENANCE

Cleaning Method:

Please use a soft brush or clean cloth to wipe the surface, disassemble the lampshade for cleaning, etc. But do not use abrasive materials such as scouring pads or abrasive powder, steel wool or sandpaper when cleaning.

Maintenance Suggestions:

1. Rated voltage 110-130V, 60Hz.
2. The glass is fragile. Wear gloves when installing to avoid scratching, handle with care and place gently. Please do not hit the light to avoid damage and injury.
3. Please do not put it in places with high humidity or high temperature.
4. Replace bulbs and clean the luminaire housing regularly.



SAFETY INFORMATION

PLEASE READ AND SAVE THESE INSTRUCTIONS

Please read and understand this entire manual before attempting to assemble, operate or install the product.

WARNING

- To reduce the risk of electrical shock, turn off the electricity at the main fuse box or circuit panel before the installation or before servicing or installing the fixture.
- To reduce the risk of fire, electrical shock or personal injury, wire connectors provided with the fixture are designed to accept only one 12 gauge house wire and no more than two lead wires from the fixture. If your house wire is larger than 12 gauge or there is more than one house wire to connect to the fixture lead wires, consult an electrician for the proper size wire connectors to use.
- To reduce the risk of fire, electrical shock or personal injury, use the mounting screws provided with the outlet box. Consult a qualified electrician if in doubt.

- DO NOT suspend any fixture by the house wires. A fixture must always be mounted directly to an outlet box or to amounting plate which is first attached to the outlet box. Wire connectors will not support the weight of a fixture. Suspending a fixture by the house wires and wire connectors will result in the fixture falling, with the possibility of personalinjury and the danger of electrical shock of fire, electrical shock or personal injury.
- DO NOT connect this fixture to an electrical system without a ground connection. Installing a fixture into an electrical system without a ground connection, it would cause metal parts electrically charged because the wire connectors or splices would be broken or loose. Under the condition, anyone who touches the fixture would get an electrical shock, injury or death.
- DO NOT connect the bare or green ground wire to the black wire(HOT)or the white wire (NEUTRAL). Because it would cause metal parts electrically charged Under the condition, anyone who touches the fixture would get an electrical shock,injury or death.



SAFETY INFORMATION

CAUTION

1. Make sure all electrical connections comply with Local Codes or Ordinances, the National Electrical Code and ANSI/NFPA 70-1999. If you are unfamiliar with electrical wiring or if the house/building wires are different colors from those referred to in the instructions, please use a qualified electrician.
2. Electrical diagrams are for reference only.
3. DO NOT use bulbs having a higher wattage than the maximum value stated on the fixture. The use of bulbs with a higher wattage than specified will increase temperatures and the risk of fire.
4. After installation is complete, check that all connections are absolutely secure.
5. The fixture must be mounted to an outlet box which is supported by the building structure and can support the full weight of the fixture. Use a metal outlet box. A plastic outlet box is not recommended.

Safety Glasses, Stepladder, Soft Cloth, Electrical Tape.

NOTE

The important safety precautions and instructions appearing in the manual are not meant to cover all possible conditions and situations that may occur. It must be understood that common sense and caution are necessary factors during the installation and operation of this fixture.

PREPARATION

- Before assembly, installation or operation of the product, make sure all parts are present.
- Compare parts with package contents list and diagrams on previous page.
- If any part is missing or damaged, do not attempt to assemble or operate the product. Contact customer service for parts replacement.
- Tools Required for Assembly (not included): Flathead Screwdriver, Phillips Screwdriver, Wire Strippers, Pliers or Wrench, Wire Cutters

PARTS INCLUDING

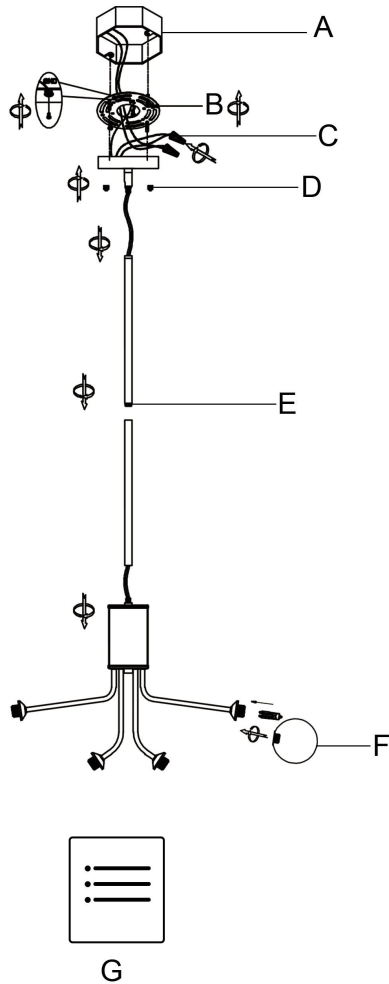

PARTS TYPE & QTY INCLUDING

- A : junction box
- B : hanging board *1
- C : wiring cap *2
- D : cylindrical screw *2
- E : lamp pole *2
- F : glass lampshade *4
- G : instruction *1

ASSEMBLY&INSTALLATION INSTRUCTIONS

- Carefully remove the fixture from the carton and check that all parts and accessories are included as shown in the above illustration.
- Turn off power Before you start the installation NEVER attempt any work without shutting off the electricity until the work is done.

- Go to the main fuse, or circuit breaker box in your home.
- Place the main power switch in the"OFF"position.
- Place the wall switch in the"OFF"

Connect wires as below wires connection shown.

PLEASE NOTE THAT GROUNDWIRE IS BARE COPPER

WIRENEVER CONNECT OTHER WIRES TO GOUND WIRES

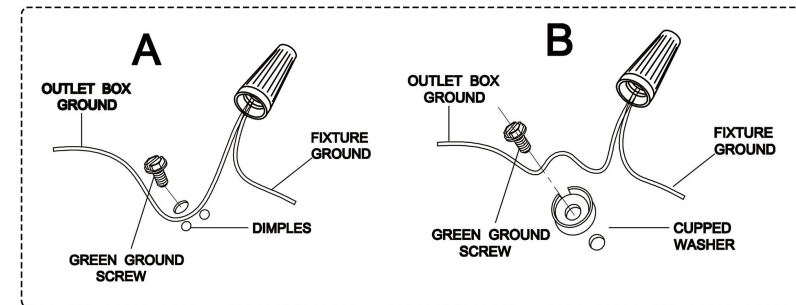

- Twist wires together with plastic wire connectors [B] until tightly joined.
- Wrap each connector with approved electrical tape.
- Be sure that no wire strands are exposed and then carefully tuck all wires into the outlet box.

INSTALLATION STEPS

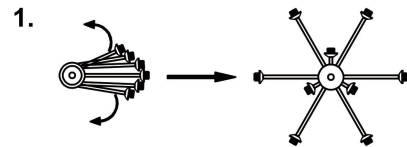

Unfold the lamp body, and adjust the distance between each pole.

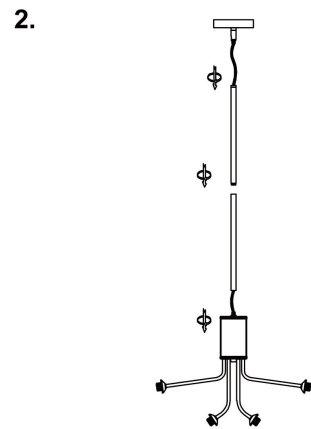

Connect the lamp poles and tighten them.

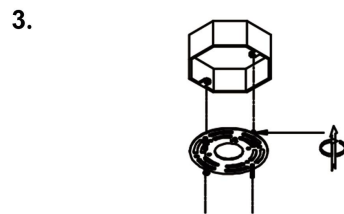

Use 2 long screws to install the hanging board in the junction box.

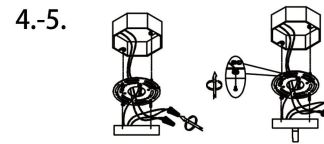

Wire the device by matching the colors of the wires. A total of 3 wires: Live wire, Neutral wire, and Ground wire. Cover the connection by tightening the wiring cap. To avoid electric shock, please do not let the copper wire expose.

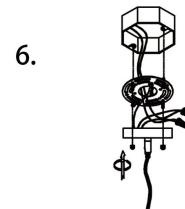

Install the lamp base on the hanging board and tighten them with the short screws on the left and right sides.

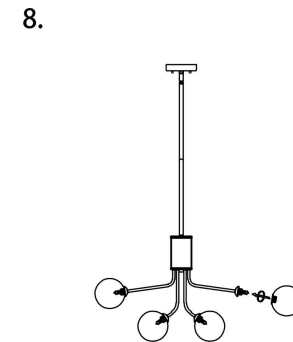
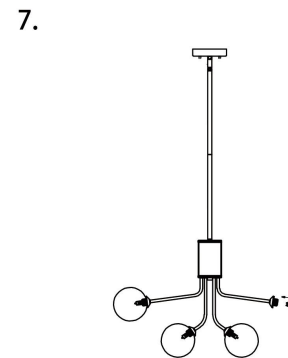

Install 9 G9 bulbs (Note: bulb is not included) .
Install the glass lampshades on the lamp holders.
Turn on the power switch and check whether the lamp works normally.