

OUTDOOR WALL LANTERN USE AND CARE GUIDE

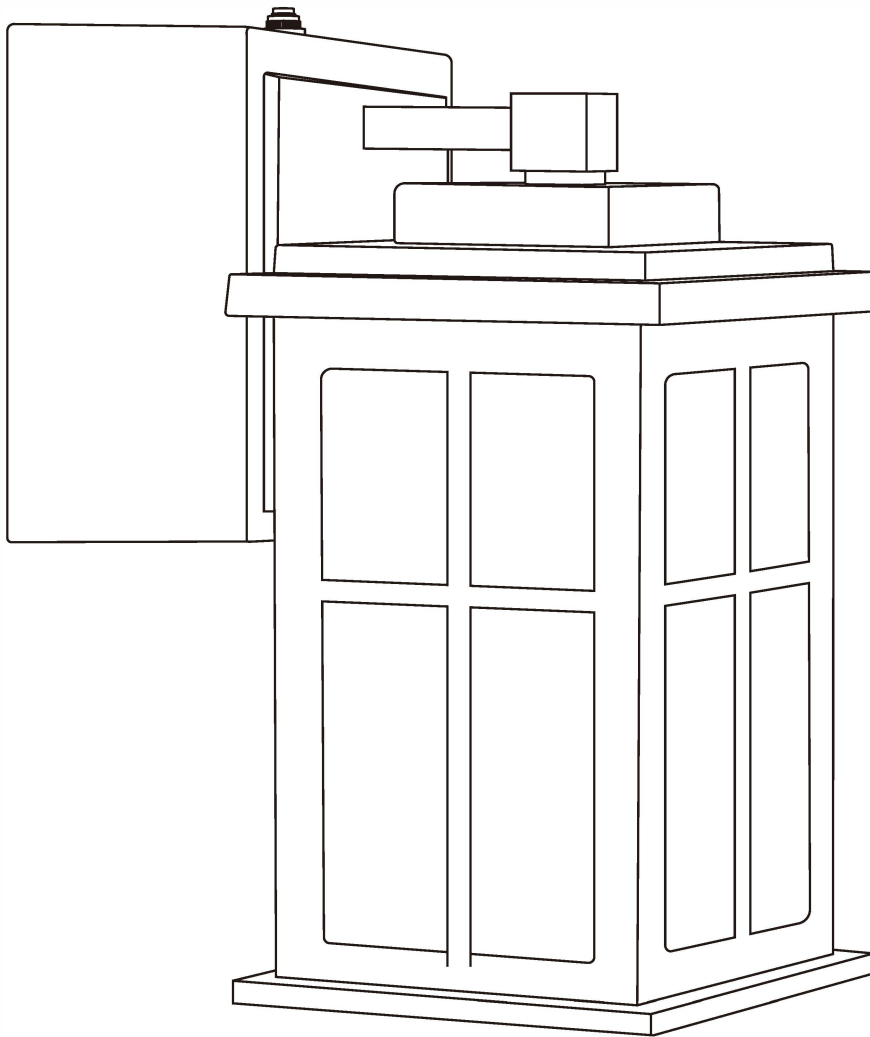



INSTALLATION INSTRUCTIONS FOR OUTDOOR WALL LIGHT



INSTRUCTIONS PERTAINING TO RISK OF FIRE OR INJURY TO PERSONS
READ ALL INSTRUCTIONS

**IMPORTANT SAFETY
INSTRUCTIONS**
SAVE THESE INSTRUCTIONS

Before starting the installation, disconnect the Power by Turning Off the Circuit Breaker. Turning the Power Off using the Light Switch is not sufficient to prevent electrical shock. All electrical connections and installation must be following local codes, ordinances, and/or National Electric Code and Must Be Done by an Electrician Only.

TYPE		
QTY	3pcs	2pcs

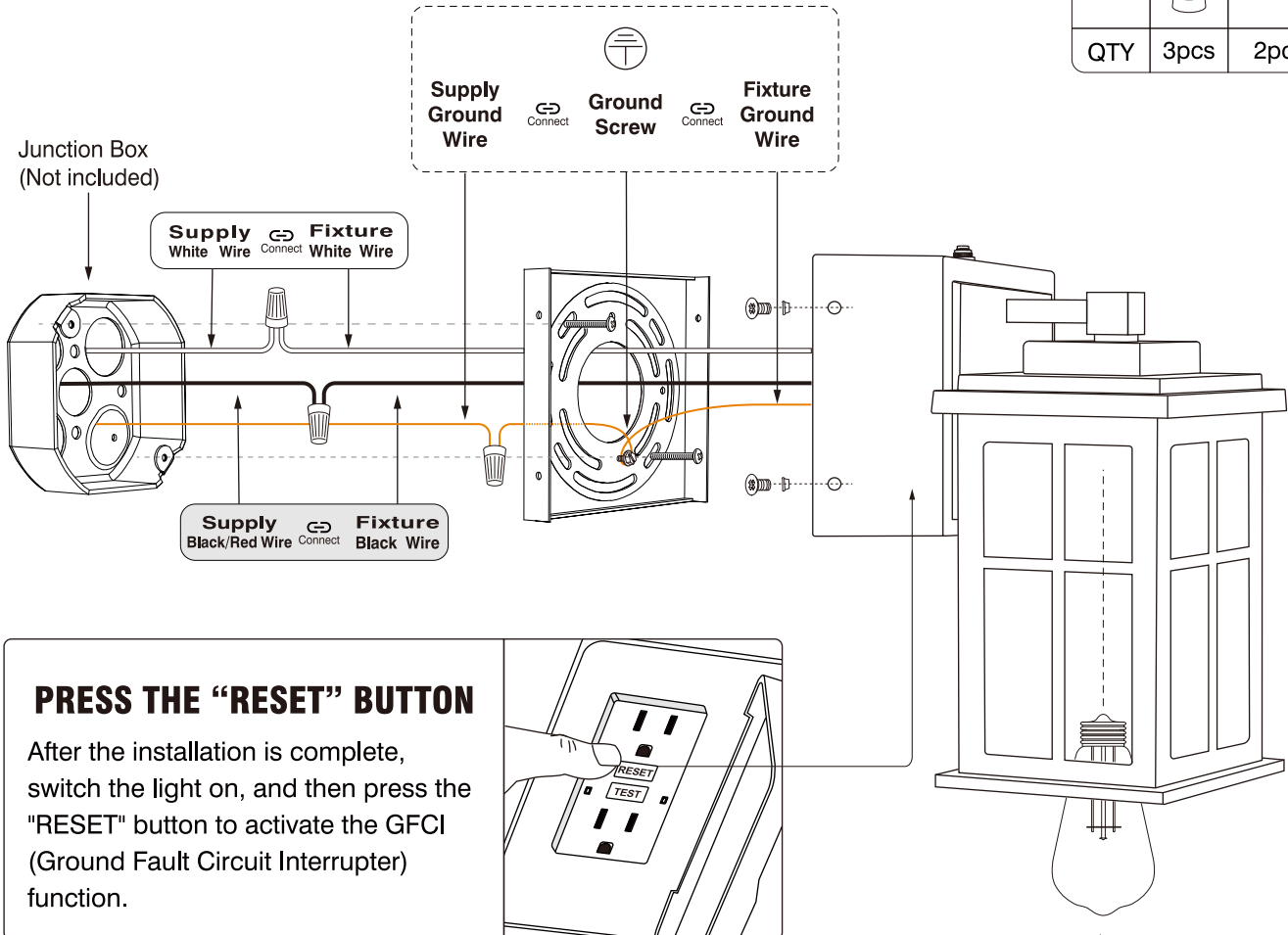

WIRE NUT USAGE STEPS:

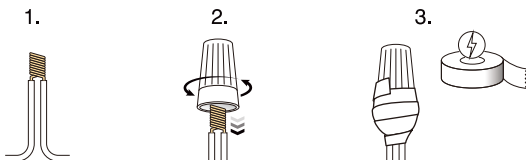

 **E26 Max.100W**

Please use E26 LED bulbs to be well compatible with the wall lantern.
(Bulbs not included)

INSTALLATION NOTES:

Please note: This lamp cannot be installed on any dimmer switch. Using a dimmer switch will damage the sensor circuit of this lamp.

When installed in dim or shaded areas, during winter, or in low-light conditions, the lamp might not switch off automatically. Please manually turn off the lamp when necessary.

ASSEMBLY INSTRUCTIONS

TOOLS AND MATERIALS REQUIRED:



Phillips
Screwdriver



Wire Cutters



Safety Gloves



Ladder

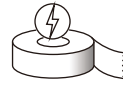

Electrical Tape

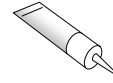

Mastic Silicone
Rubber



Safety Glasses

INSTALLATION:

Note: the product may not look exactly as shown in the figures.

Please install the light fixture in the correct orientation as shown in the diagram. Damage caused by incorrect installation, resulting in water ingress, is not covered by the warranty.

<p>1</p> <p>Mounting Bracket</p> <p>Junction Box (Not included)</p>	<p>Remove the Mounting Bracket from the Fixture and attach it to the Junction Box with 2 screws.</p>	<p>4</p> <p>Fixture</p> <p>Screws</p>	<p>Then secure the fixture to the mounting bracket with 4 screws</p>
<p>2</p> <p>Ground Screw</p>	<p>Connect the white wire of the fixture to the white wire of the power supply. Connect the black wire of the fixture to the black wire of the power supply (or to the red wire of the power supply). Fix the ground wire with ground screw and then connect it to the power supply ground wire (See page 1 for detailed illustrations)</p>	<p>5</p>	<p>Install the proper bulb type and wattage (not included).</p>
<p>3</p> <p>White</p> <p>Black</p> <p>Junction Box</p> <p>Ground Wire</p>	<p>Once connections of wires are completed, carefully tuck wires and wire nuts into the electrical box making sure no bare wire (on the black and white) is visible at the wire nuts.</p>	<p>6</p> <p>Fixture backplane</p>	<p>After installation, use weatherproof caulk (not included) to seal the gap between the lamp and the wall, as well as the gap at the screw, and the bottom should not be filled to prevent moisture accumulation. The bottom should be left un-caulked to prevent moisture build-up.</p>

1-YEAR LIMITED WARRANTY*

This light fixture is warranted against defects in material and quality for a 1-year period from the purchase date.

Exclusions from Warranty:

- Damage caused by acts of nature, such as lightning damage or corrosion and discoloration of components.
- Damages resulting from abuse, improper installation, electric surges, or actions of third parties.
- Costs related to removing and resealing the lighting fixture.
- Damage caused by incorrect installation orientation.

If this product fails for any reason covered by this warranty, feel free to contact us.

QUICK GUIDE



Dusk To Dawn Sensor

The sensor can turn on and off the lamp according to the ambient light. When the light is dark, such as at night (5-60Lux Outdoor natural light), the lamp will automatically turn on, and when the surrounding environment is bright, such as after dawn, the lamp will automatically turn off. So you don't have to manually turn on or off the lights, you can keep the switch always on, and automatically turn on and off every day, saving your electricity bills.

If you want to disable this feature, cover the sensor with dark tape.

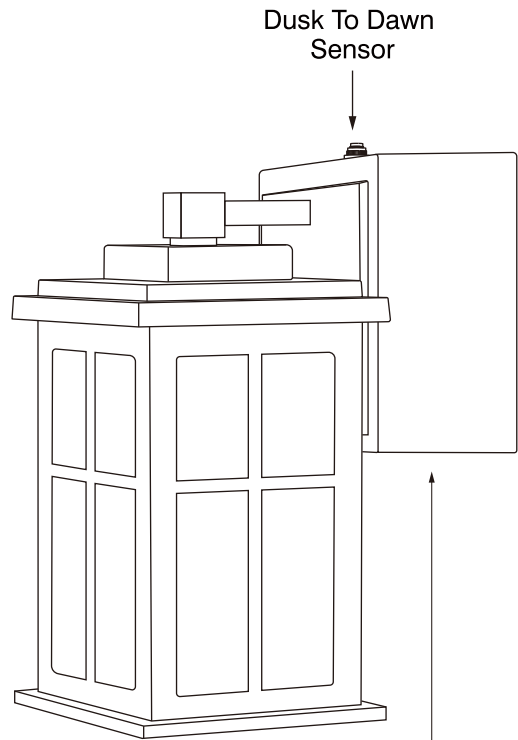

GFCI Outlet Usage Guide

1. After correct installation and powering on, when the "RESET" button is pressed, the green indicator light should illuminate, and the light fixture and appliances connected to the GFCI will start working.
2. When the "TEST" button is pressed, the "TEST" button will pop out, the green indicator light will go off, and the light fixture and appliances connected to the GFCI will stop working.
3. If the light fixture still does not work after being correctly installed and powered on, please check if the GFCI "RESET" button has been pressed; at this point, the green indicator light should be on.

Specificatio

Hard-wired 125VAC 60Hz MAX:1800W
12 AWG wire recommended.

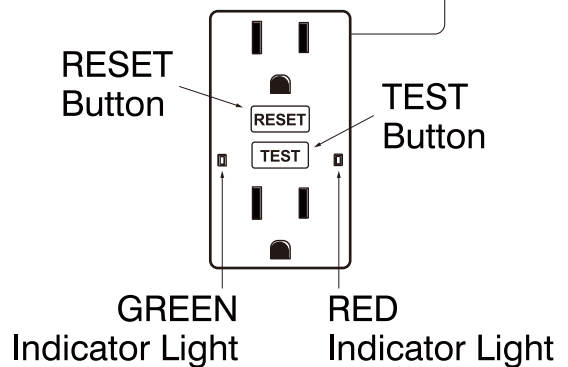

It is prohibited to install GFCI receptacles on circuits that supply power to life support equipment!



Please refer to the GFCI Outlet manual for more detailed function settings.