

PALLAS

LIGHTED MEDICINE CABINET WITH TUNABLE LED

SKU: 950613

BEFORE YOU BEGIN

We recommend consulting a professional if you are unfamiliar with installing bathroom fixtures. Signature Hardware accepts no liability for any damage to the wall, medicine cabinet, or for personal injury during installation.

Observe all local plumbing and building codes.

Unpack and inspect the product for shipping damage. If any damage is found, contact our Customer Relations team at 1-866-855-2284.

GETTING STARTED

- Ensure that you have gathered all the required materials that are needed for the installation.
- Before installing, please turn off the main power switch and ensure that it won't turn on.
- This medicine cabinet is heavy; do not lift or install without assistance to avoid injury.

TOOLS AND MATERIALS:

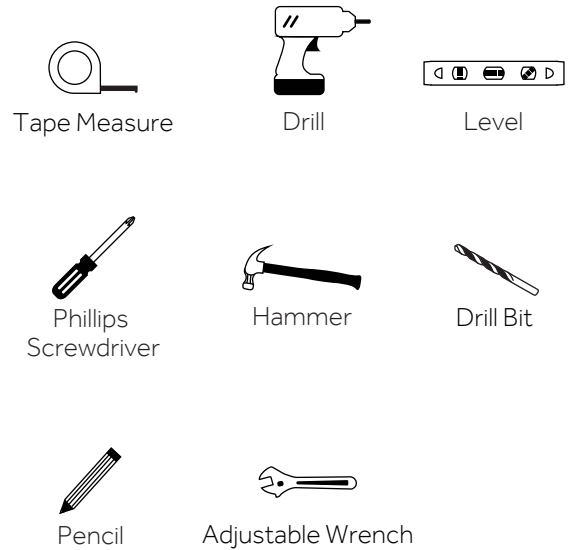

For Warranty information, please visit: signaturehardware.com/services/warranty

REVISED 02/23/2021
CODES: 532116, 532117, 532118

PALLAS

LIGHTED MEDICINE CABINET WITH TUNABLE LED

SKU: 950613

INSTALLATION

1. After selecting the location of the medicine cabinet, check whether the wall is solid, measure the distance of the mounting holes in the support bar with a tape measure and mark it on the wall with a pencil.

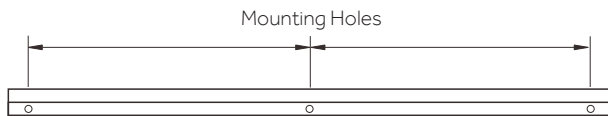

2. Drill holes in the marked position with electric drill and $\varnothing 8$ drill bit, use special ceramic drill if the wall surface is ceramic tile. Insert wall anchors into the pilot holes, and then tighten the screws with a screwdriver to fix the mounting bar. Make any adjustments to ensure mounting bar is level.

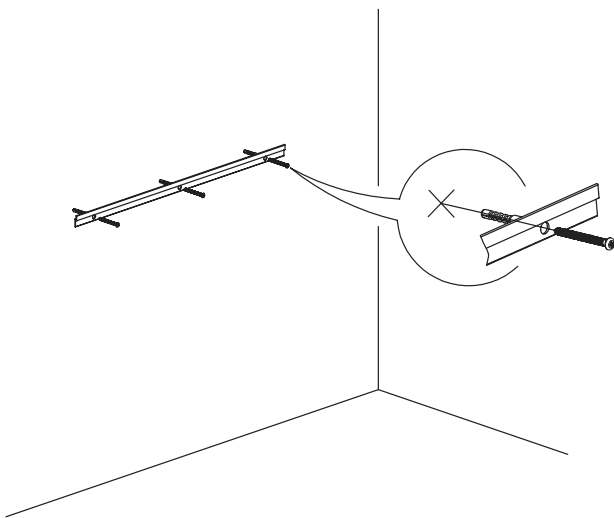

3. Install the glass into the cabinet from the back side as shown.

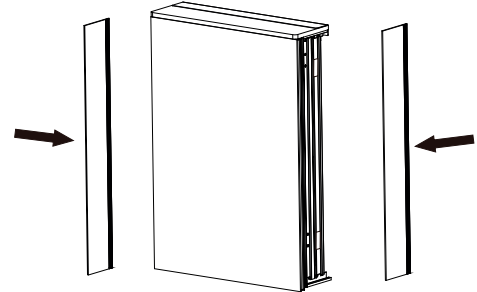

4. Using the adjustable wrench, remove the nut (Fig 1). Install the fixed mount and reattach the nut (Fig 2).

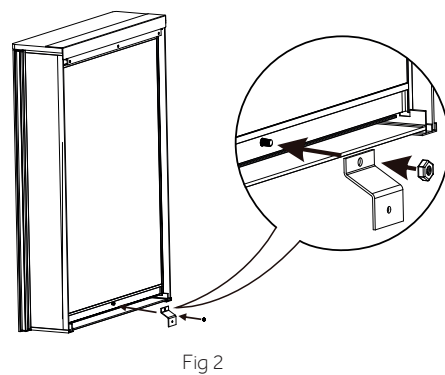
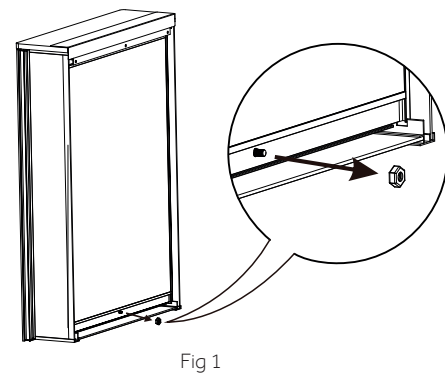

PALLAS

LIGHTED MEDICINE CABINET WITH TUNABLE LED

SKU: 950613

3. Attach the medicine cabinet to the mounting bar as shown, make a mark on the wall through the hole (A) of the fixed mount with a pencil.

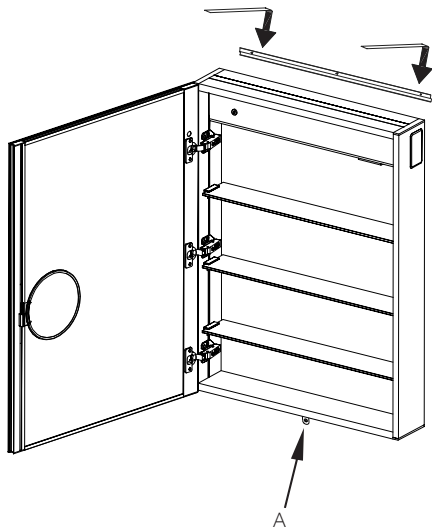

4. Remove the medicine cabinet, drill the mounting hole in the wall in the marked position, and place the wall anchors.

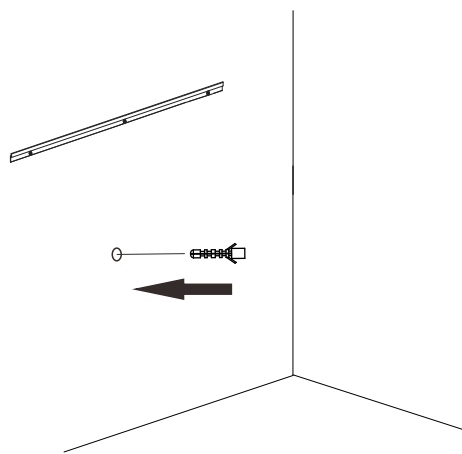

5. Mount the medicine cabinet on the mounting bar, make sure that electricity is not on going in to the unit and connect the three wires reserved on the wall to the three wire terminal block on the product, and then tighten the screws on the backplane (A).

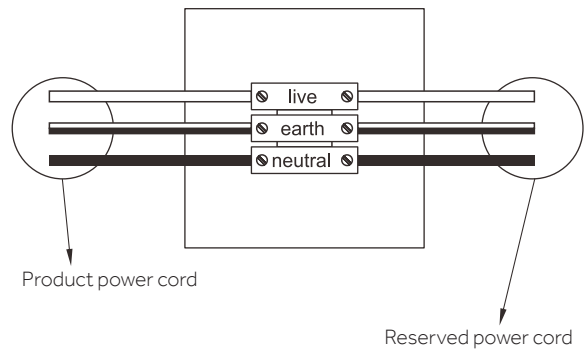
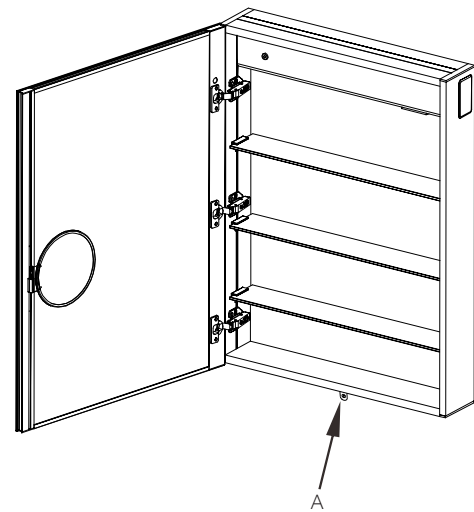

6. Turn on the power and check the products performance

PALLAS

LIGHTED MEDICINE CABINET WITH TUNABLE LED

SKU: 950613

CABINET DOOR ADJUSTMENT

1. Attach the medicine cabinet, and check if the mirror door is flat; if not adjust the distance of the door opening by adjusting the hinge screw (B).

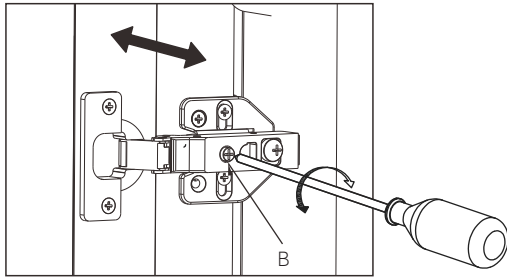

Rotate Clockwise: Door moves to the center of the medicine cabinet.

Rotate Counterclockwise: Door moves to side of medicine cabinet.

2. If the cabinet door isn't flat, adjust the distance between the door and the cabinet by adjusting the screw (C) to make the door flat.

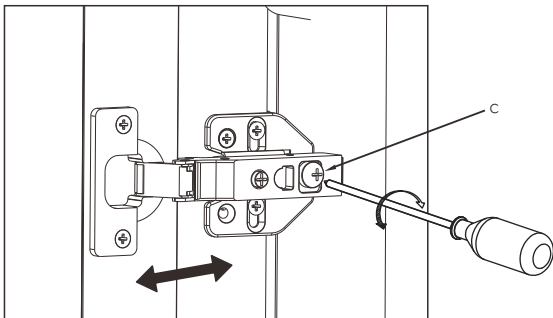

Rotate Clockwise: Distance between door and cabinet reduces.

Rotate Counterclockwise: Distance between door and cabinet increases.