



















Hardware

Tools Required

Power tools NOT recommended

NO.	Quantity	Accessory
A	4	 Metal Bracket
B	12	 5x60 mm
C	32	 3.5x30 mm
D	12	 Screw 8X25 mm
E	3	 Center Leg
F	1	 Allen Wrench 5mm
G	2	 Headboard Leg
H	2	 Screw 8X45 mm
I	2	 Washer 8mm

NO.	Quantity	Accessory
A	4	 Metal Bracket
B	12	 5x60 mm
C	32	 3.5x30 mm Sc
D	12	 rew 8X25 mm
E	3	 Center Leg
F	1	 Allen Wrench 5mm
G	2	 Headboard Leg
H	2	 Screw 8X45 mm
I	2	 Washer 8mm

King Bed

Queen Bed

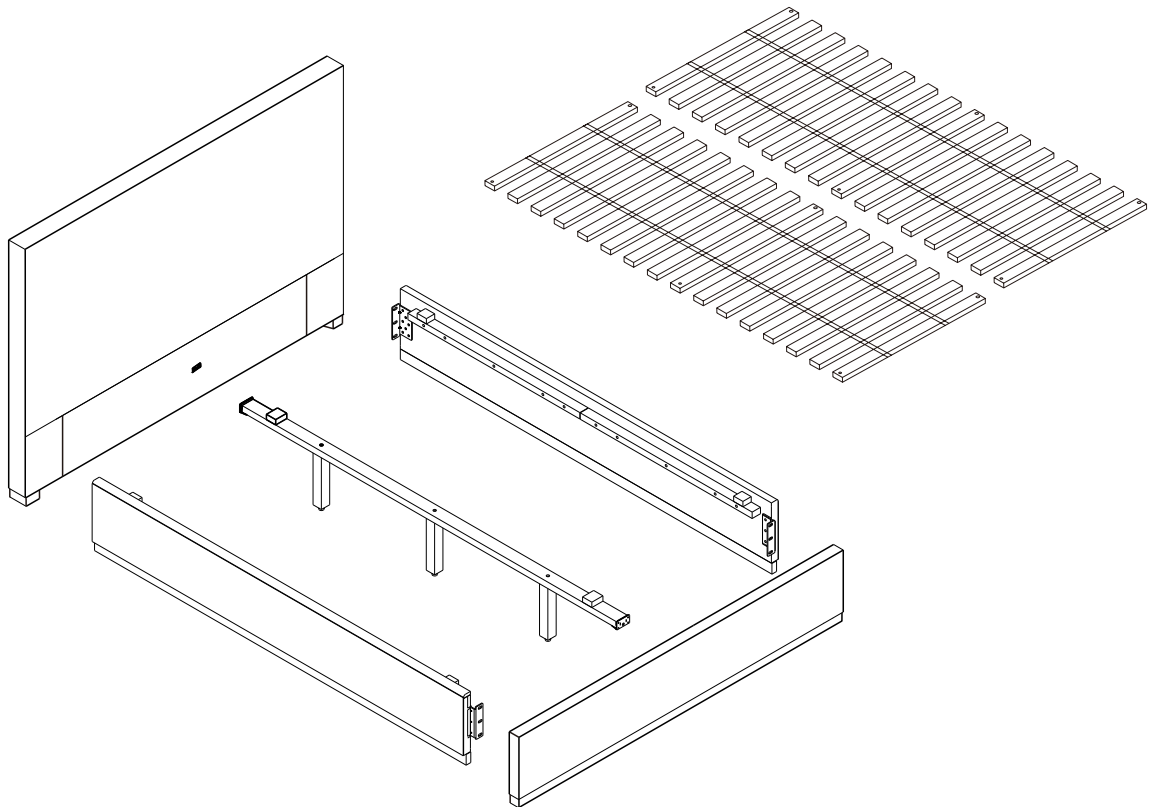

- 1) Place the headboard upright.
- 2.) Attach Leg (G) by inserting screw (H) with washer (I) into the pre-drilled hole and tighten securely using Allen wrench (F).
- 3). Align the left and right side rails with the connection points on the headboard and footboard.
- 4). Use the provided metal brackets (A) to join the side rails to the headboard and footboard. Use screws (C) and bolts (D) to secure, fully tighten the connection.

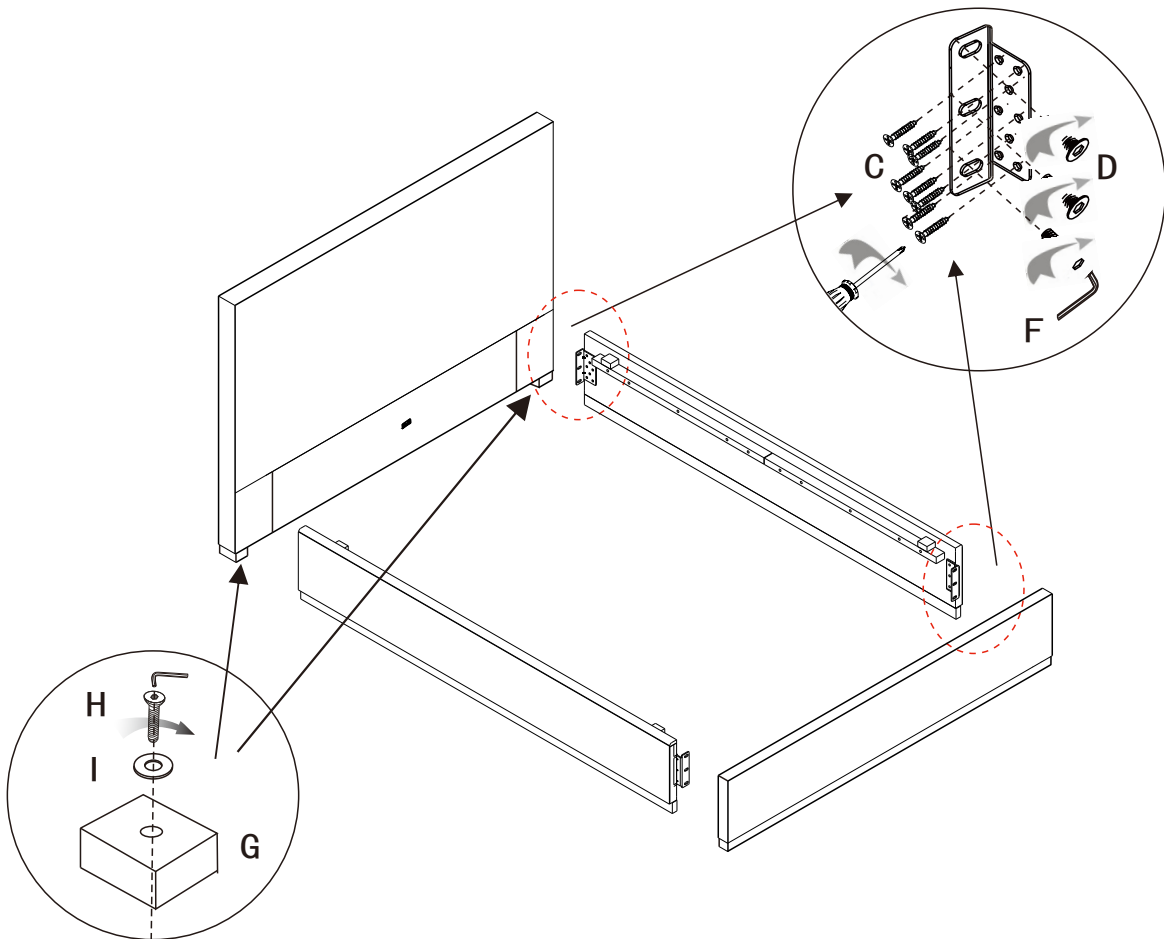

- 2) 1). Insert the 3 support legs (E) into the designated holes along the underside of the center rail.
- 2). Twist each leg to adjust the height and ensure all legs are at the same level for even support.

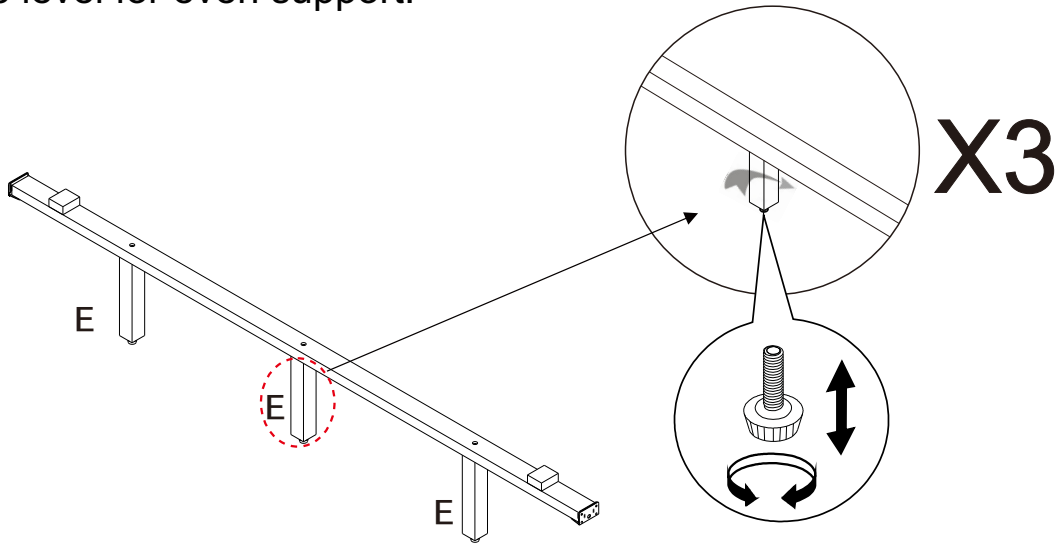

- 3) 3) Position the center support rail between the side rails and attach each end of the center rail to the brackets on the side rails.

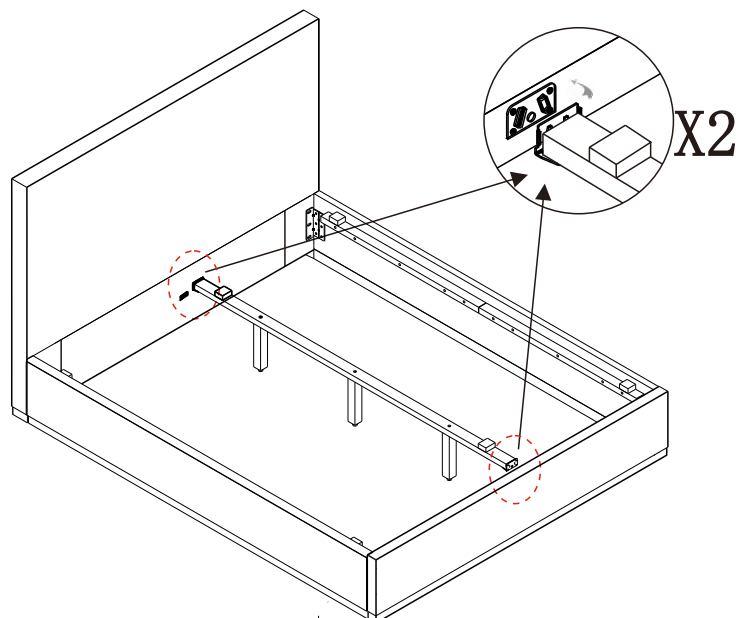

- ④ 1). Place the slats evenly across the bed frame.
- 2). Secure the slates using the screws (B).
- 3). The bed is fully assembled and ready to use.

