

# ASSEMBLY INSTRUCTIONS

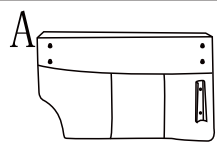

X1

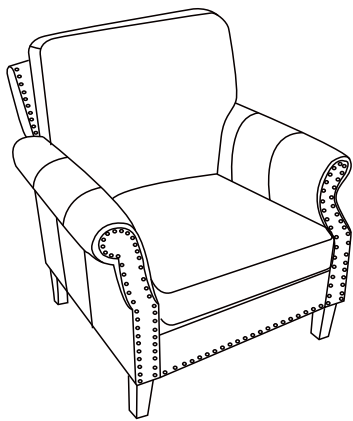
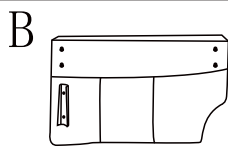

X1

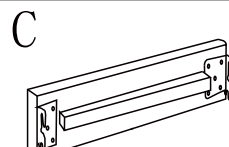

X1

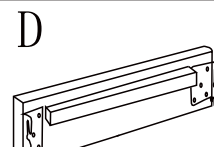

X1

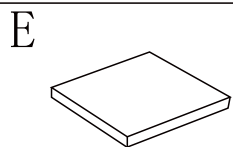

X1

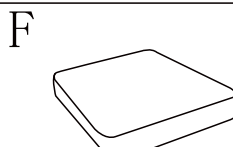

X1



X1

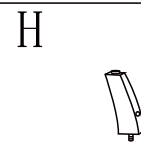

X2

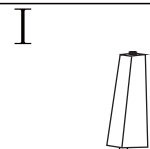

X2

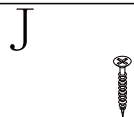

X2

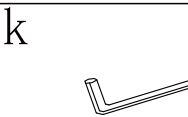

X1

## Step:1

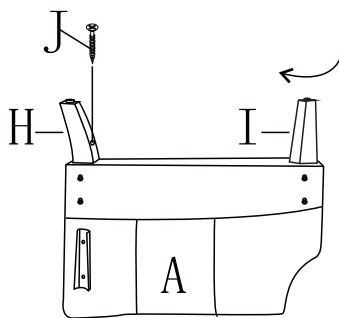

## Step:2

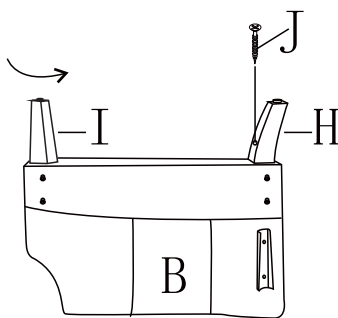

## Step:3

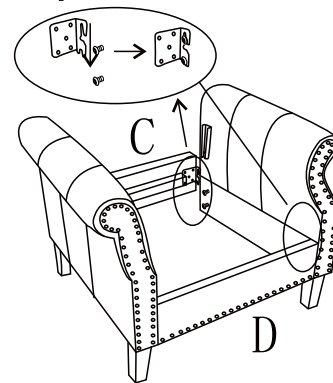

## Step:4

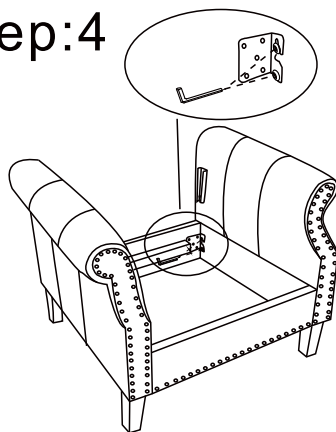

## Step:5

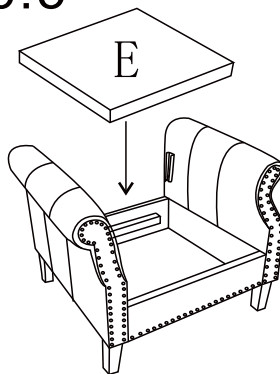

## Step:6

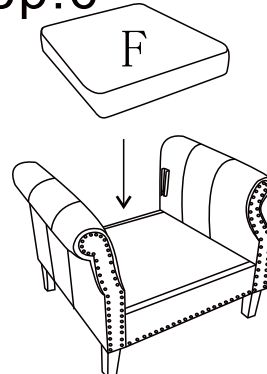

## Step:7

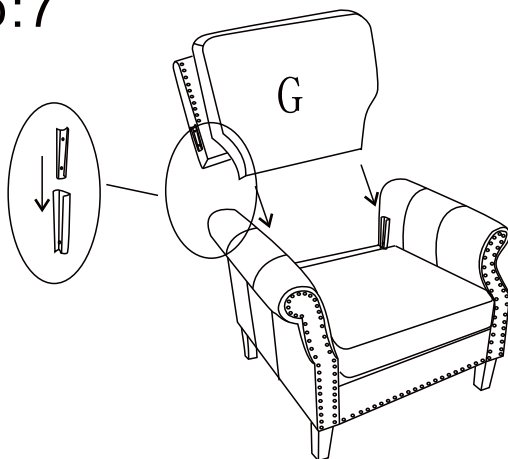

## Step:8

