

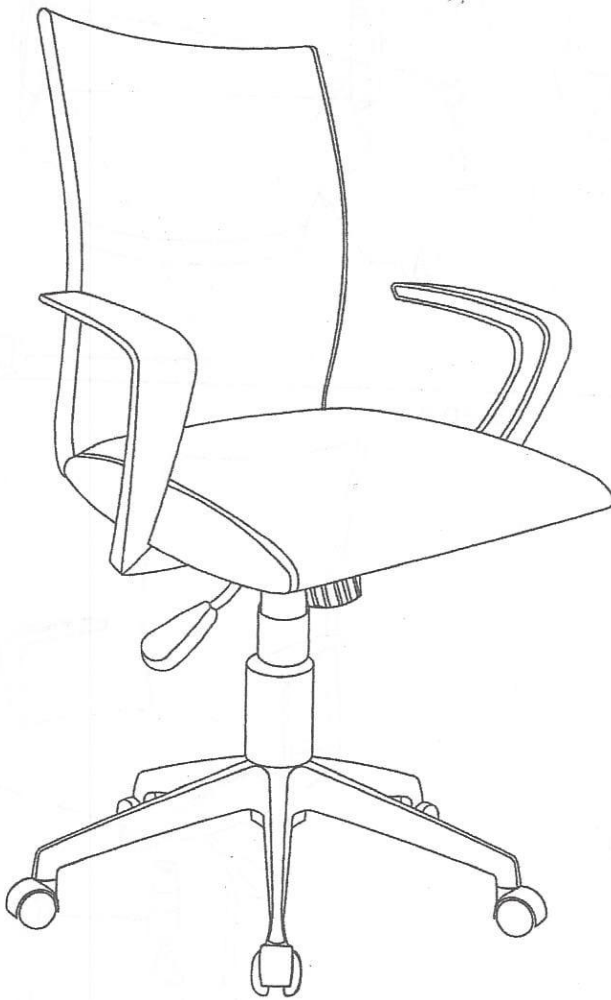













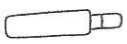

Thank you for purchasing products.
Contact customer service for comments or concerns.

Assembly Instructions, Apostrophe Office Chair



A: Back	
B: Seat	
C: Arm	
D: Seat Tensioning Plate	
E: Spider Base	
F: (5) Casters	
G: Cover	
H: Gas Lift	
I: (6) Bolts M6*35mm	
J: (4) Bolts M6*30mm	
K: (2) Bolts M6*25mm	
L: (2) Bolts M6*20mm	
M: (10) Flat Washers Ø6*16	
N: (10) Lock Washers	
O: Allen Wrench	

Step 1

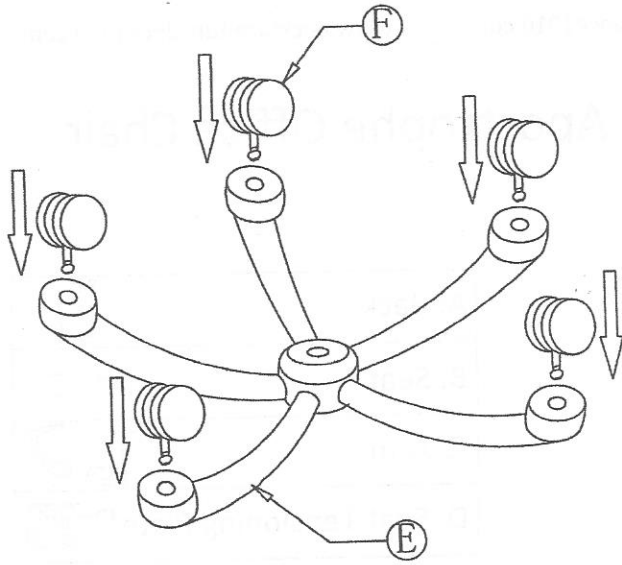

Step 2

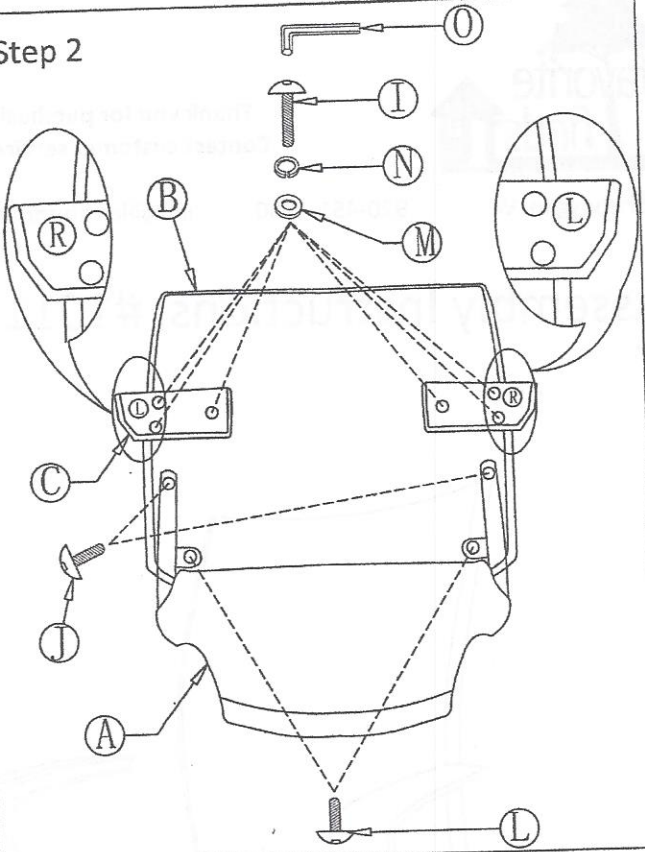

Step 3

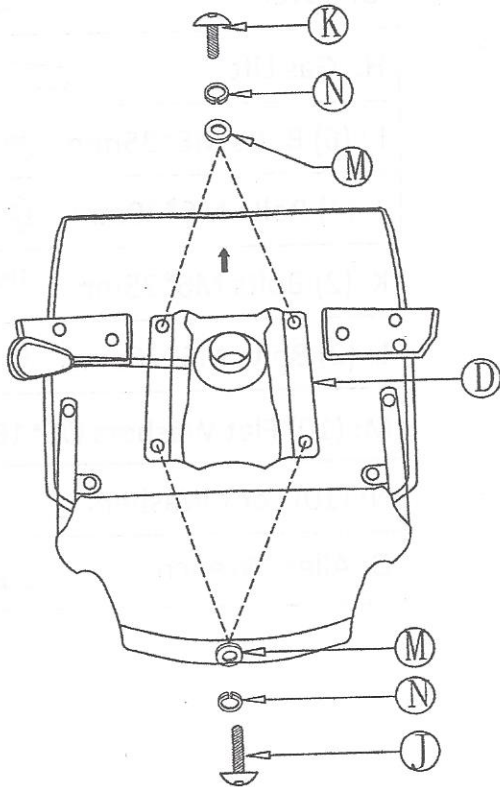

Step 4

