



*UXFYG001*

## **Instruction Manual**

Thanks a lot your support and purchasing.

Please feel free to contact us if you have any questions with assembly or need replacement parts.

# Assembly Instruction

Decorate your home, Brighten wonderful life

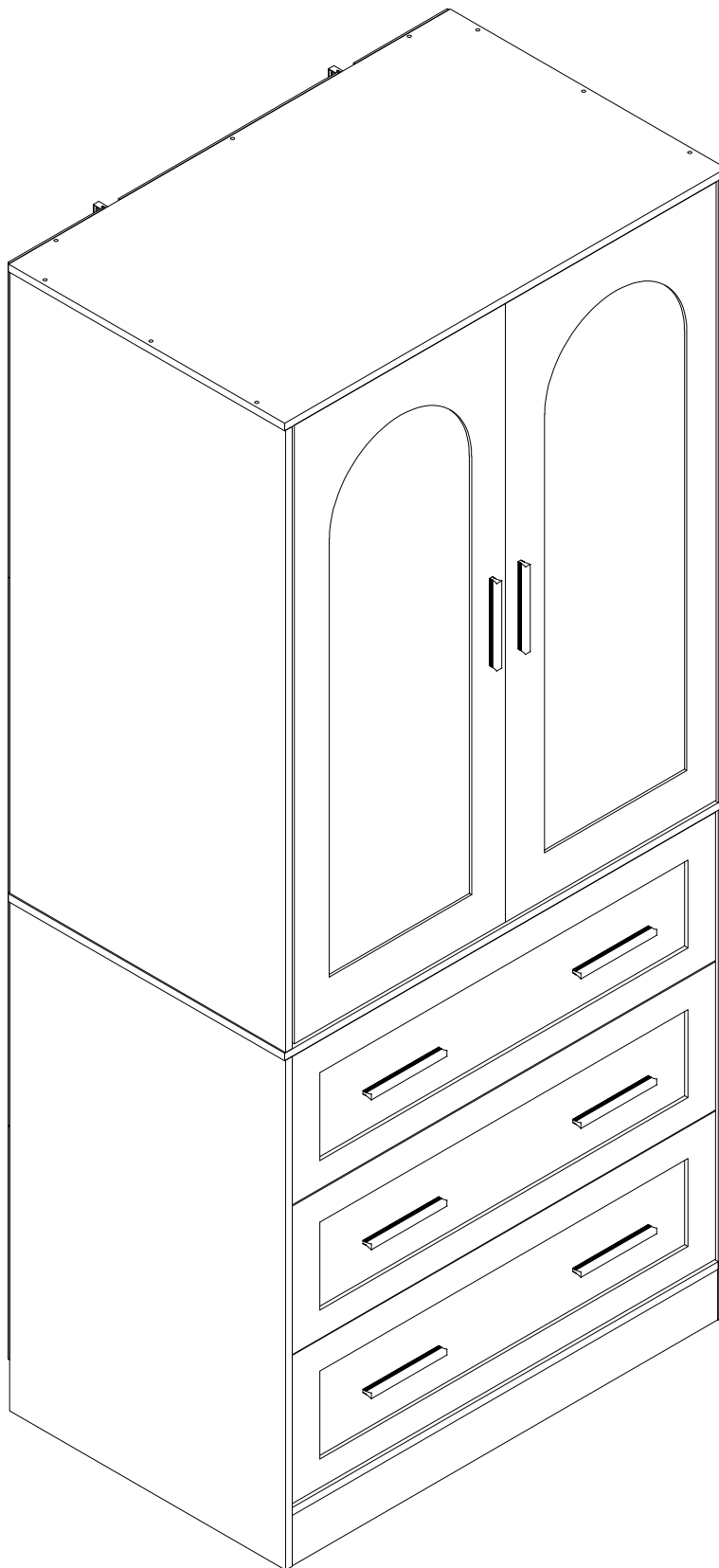

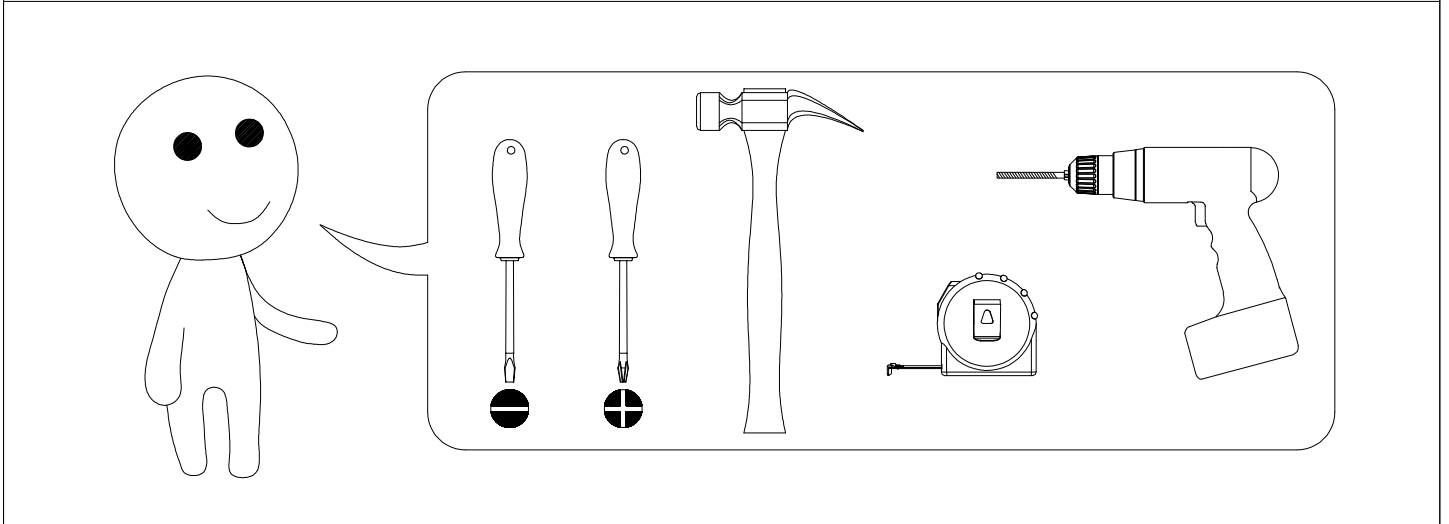
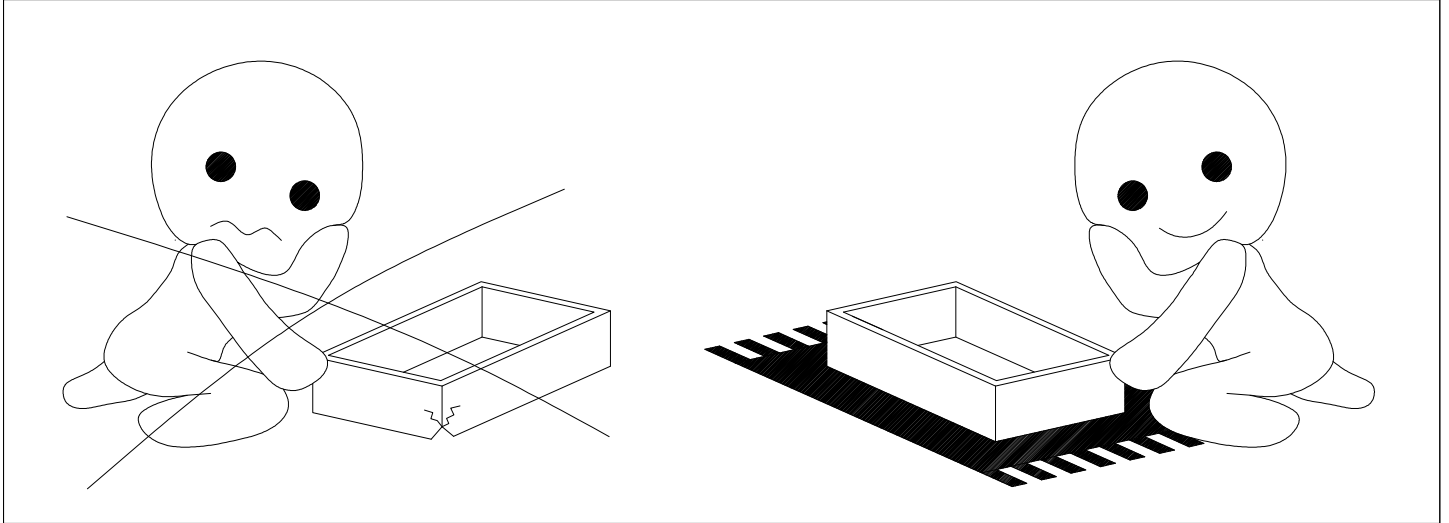
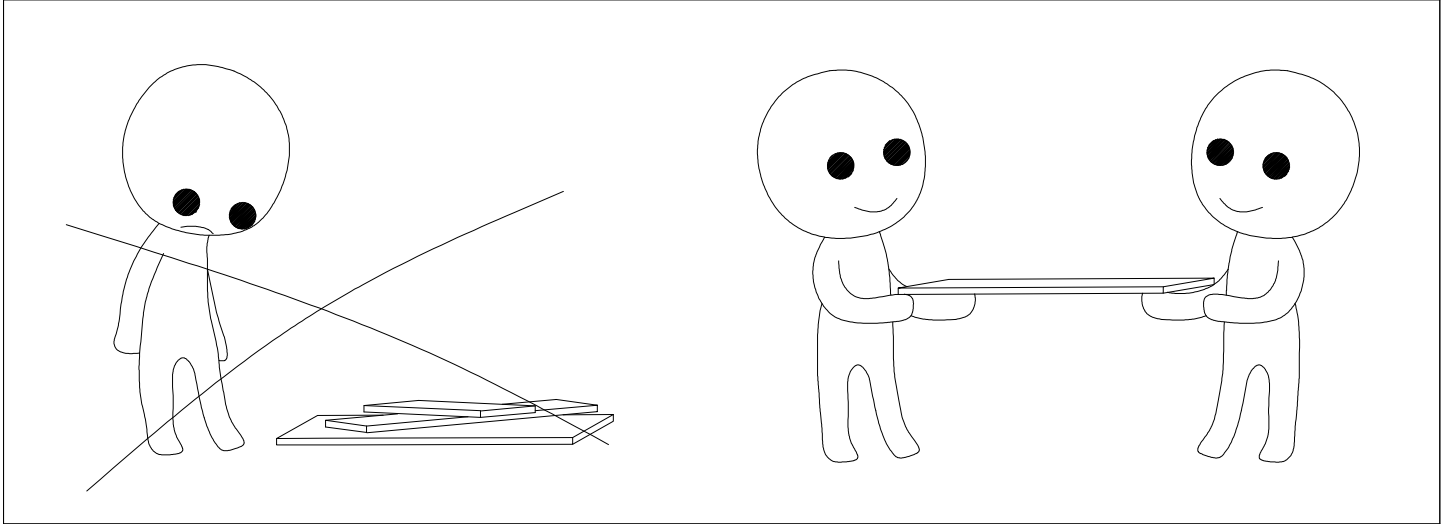
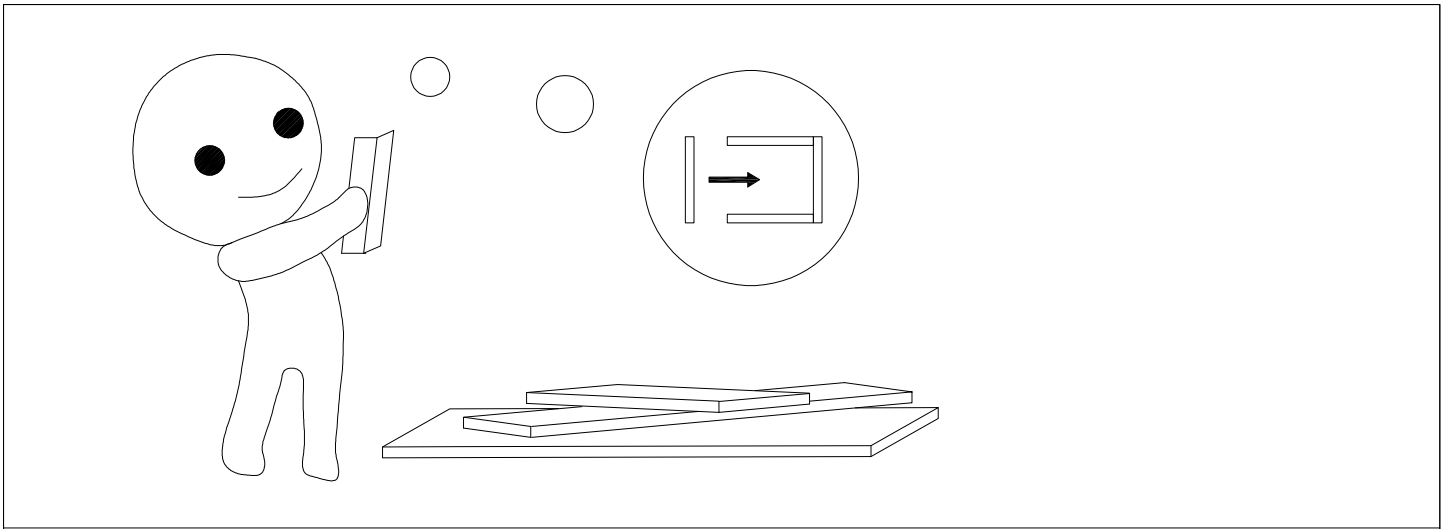

# PLATE NUMBER

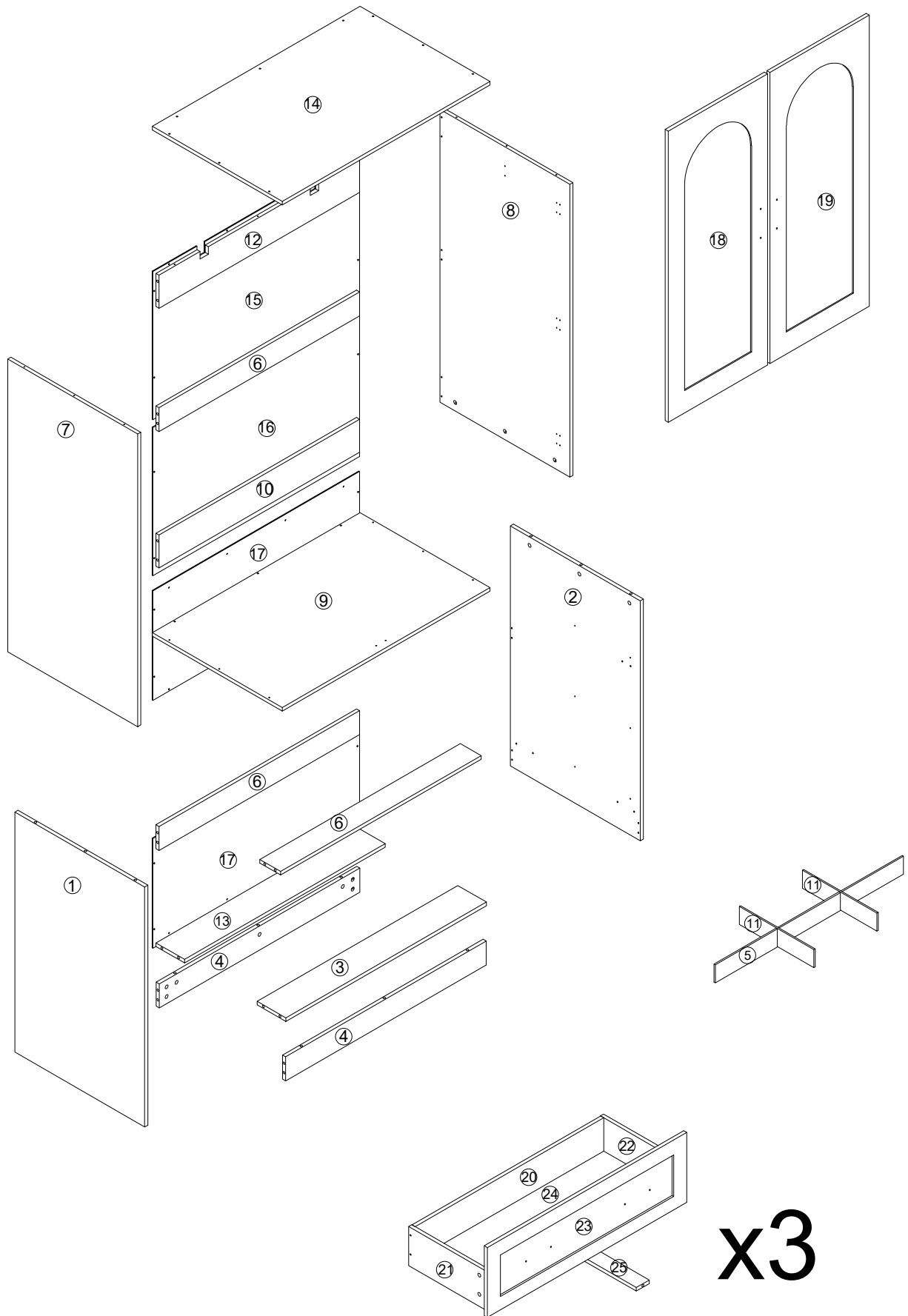

# ACCESSORIES LIST

A ×69

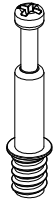

M6×35

B ×69

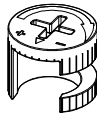

12×10

C ×27

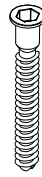

M5×40

D ×40

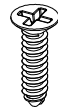

M3×12

E ×3

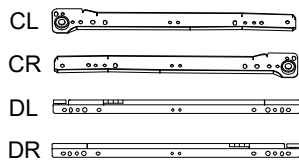

M300

F ×42



M3.5×12

G ×48

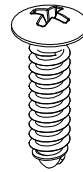

M4×12

H ×4

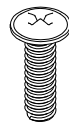

M4×14

J ×1

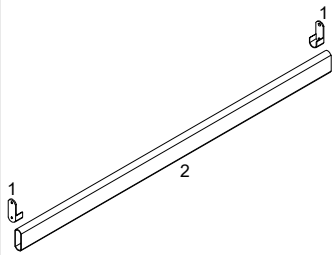

K ×4

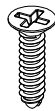

M3×14

L ×2

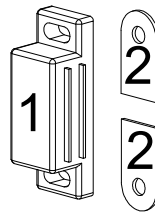

M ×8

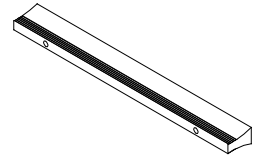

M96

N ×2

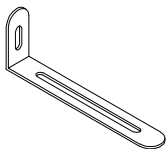

P ×2

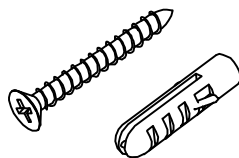

Q ×6

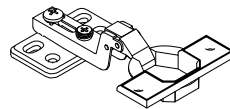

R ×12

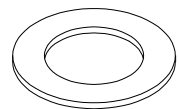

S ×12

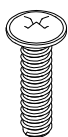

M4×6

# STEP1

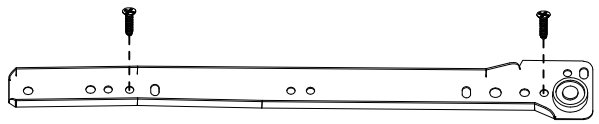
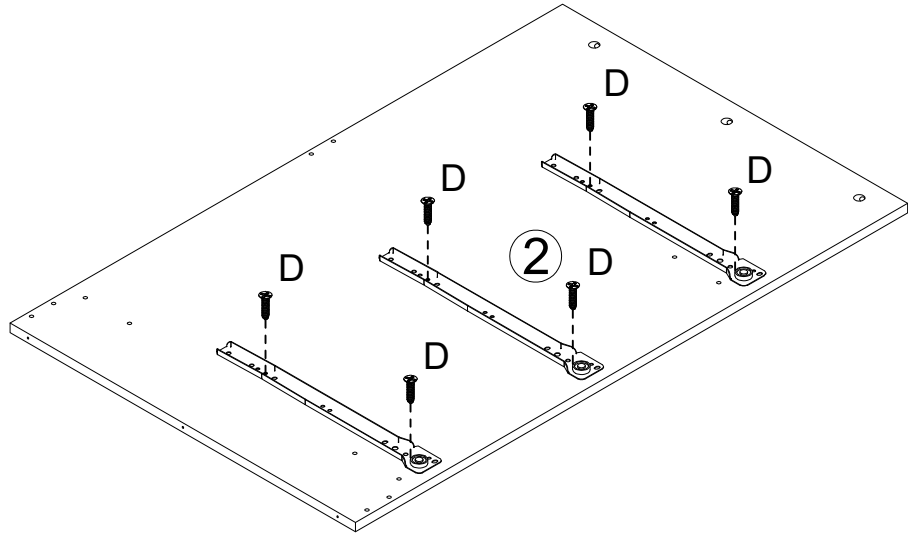
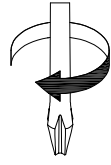

E-CRx3

Dx6

# STEP2

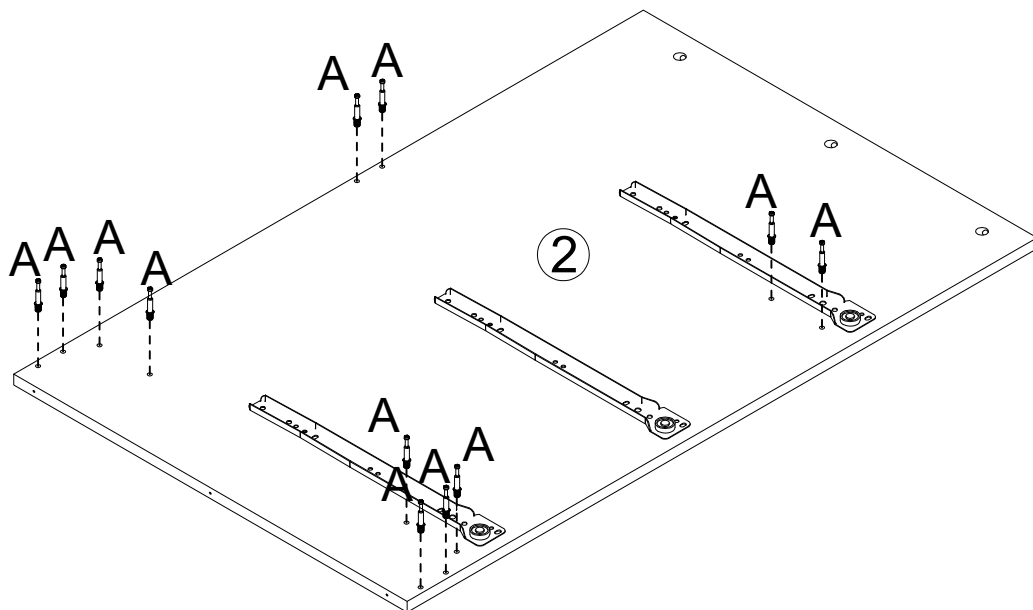
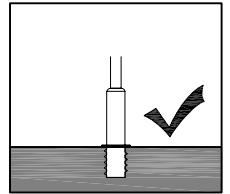
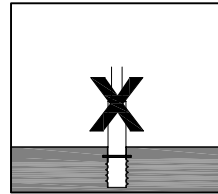
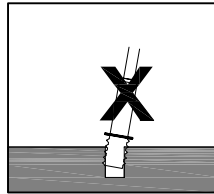
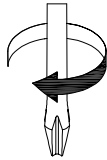

Ax12

### STEP3

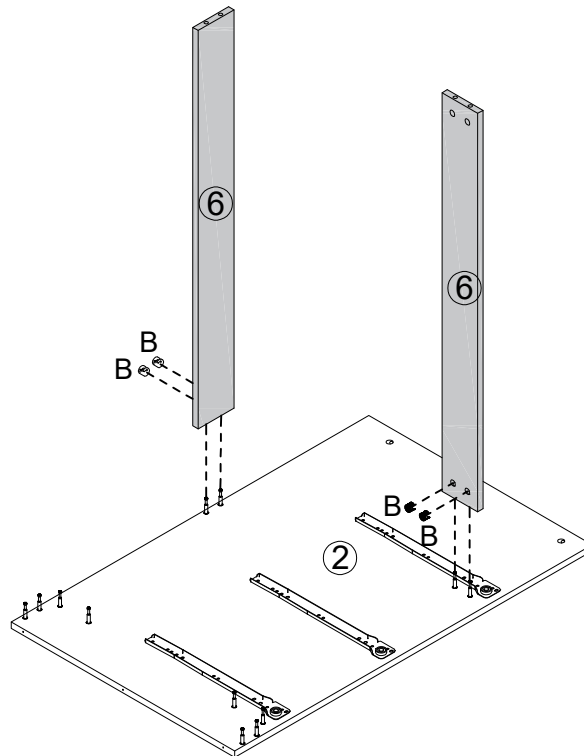
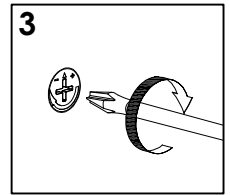
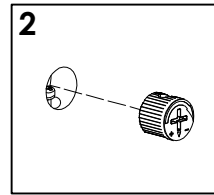
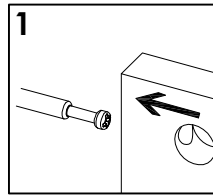
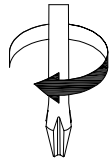

Bx4

### STEP4

Iron Rod A is prohibited from using an electric drill.

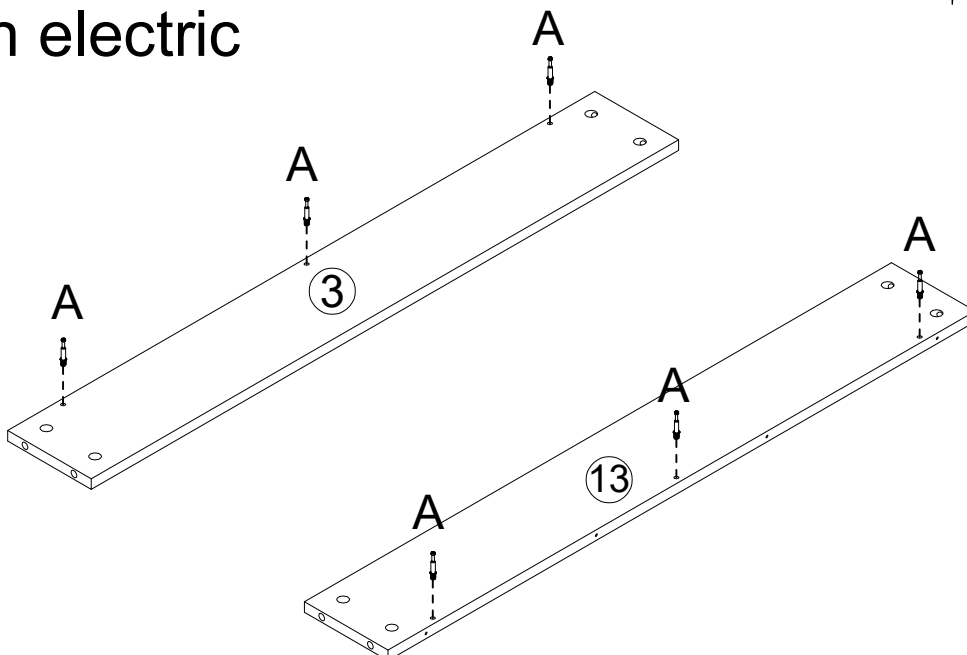
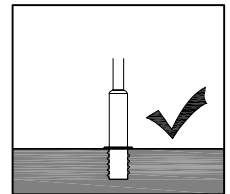
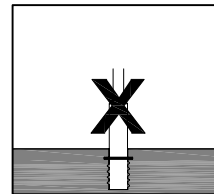
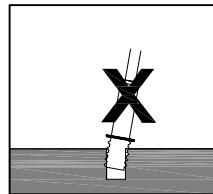
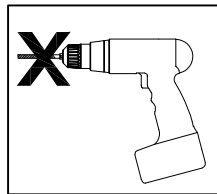

Ax6

# STEP5

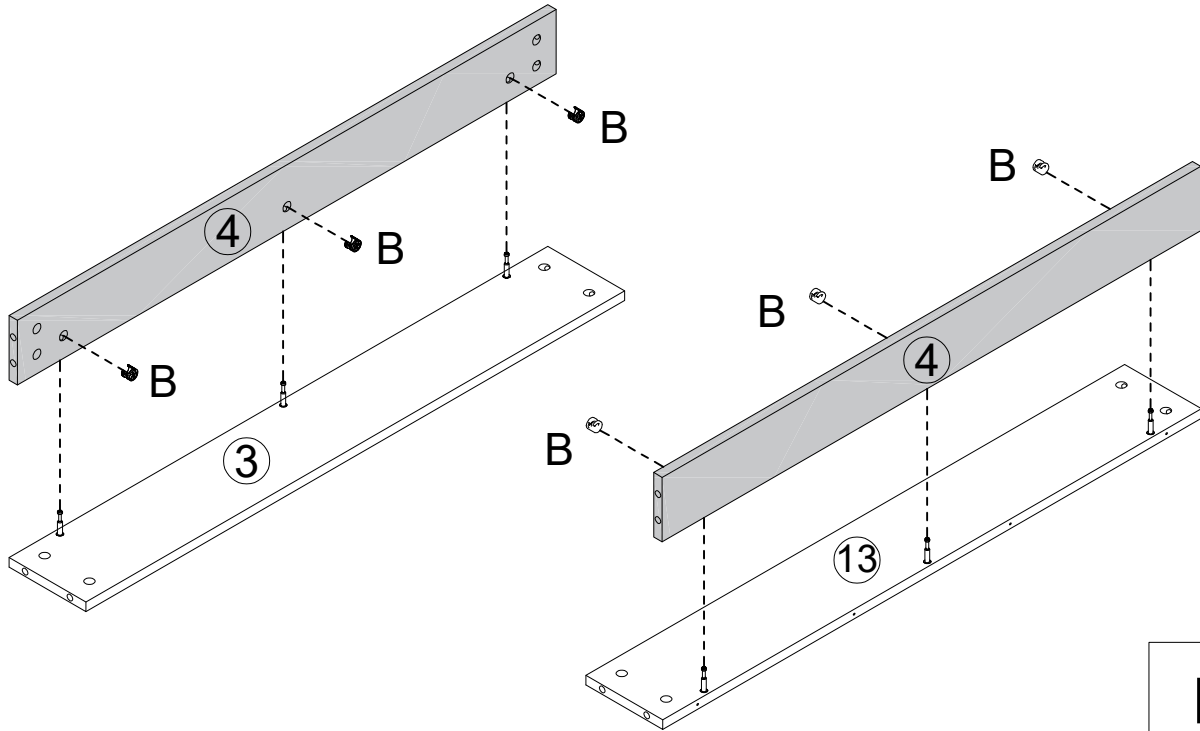
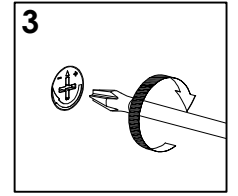
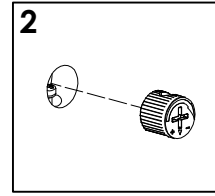
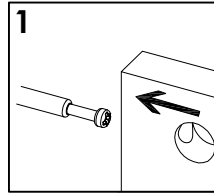
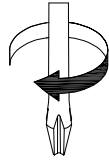

Bx6

# STEP6

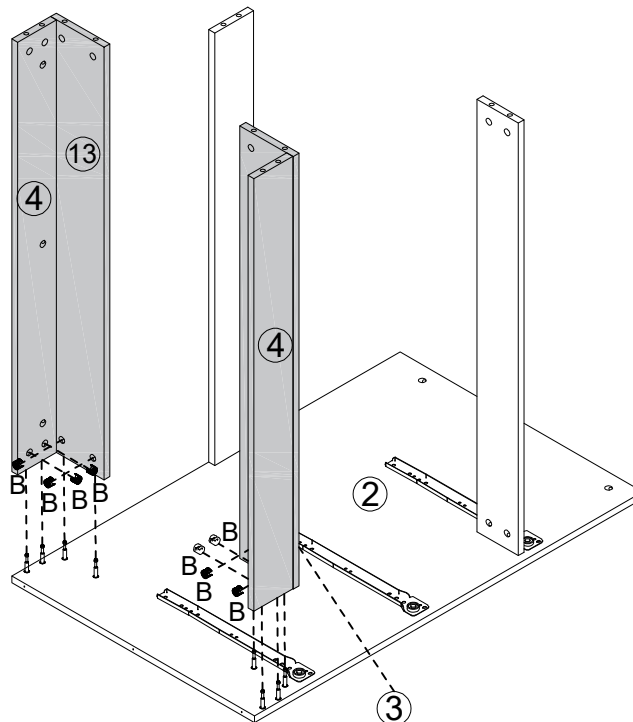
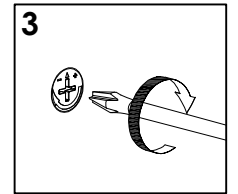
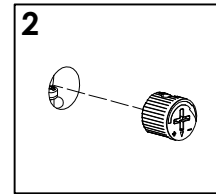
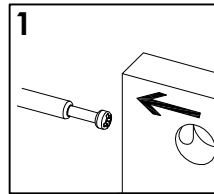
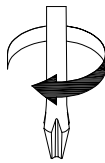

Bx8

# STEP7

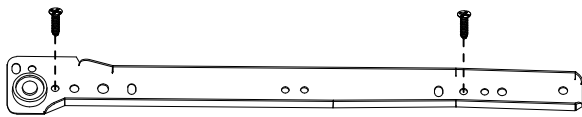
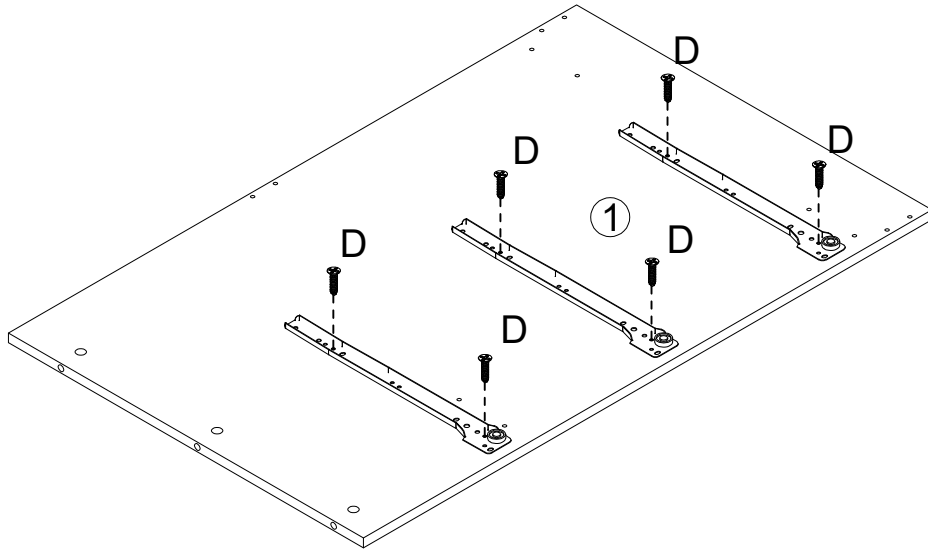
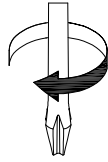

E-CLx3

Dx6

# STEP8

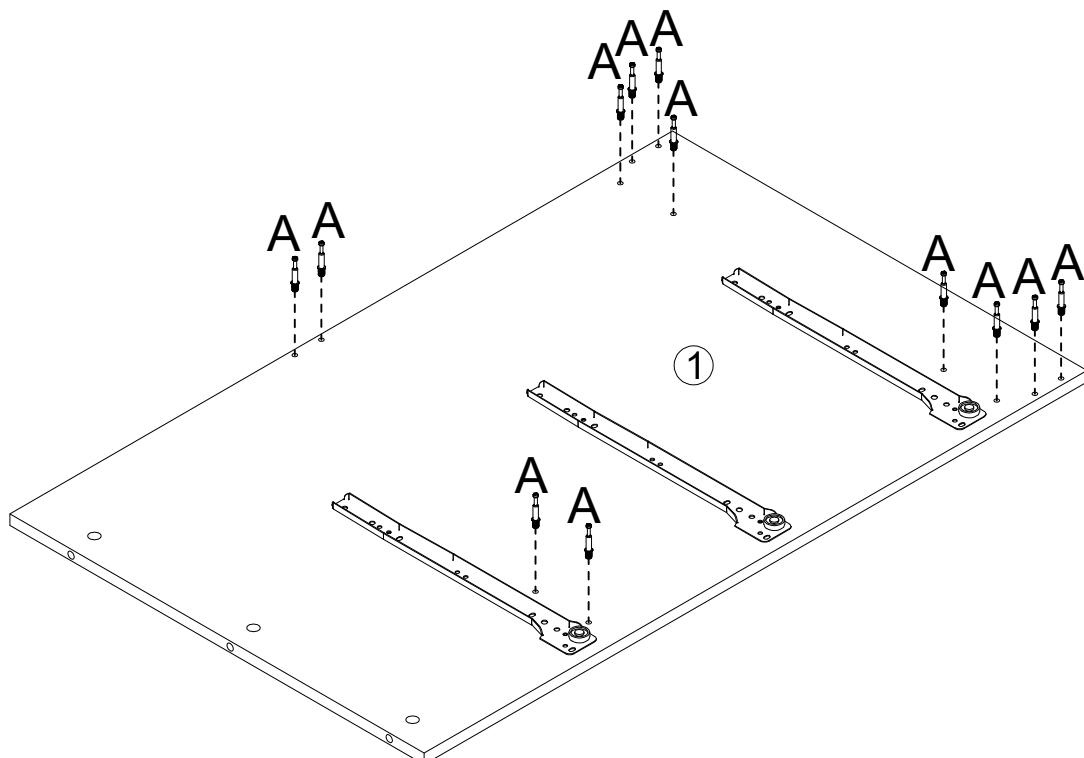
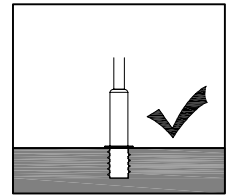
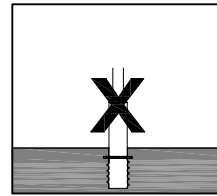
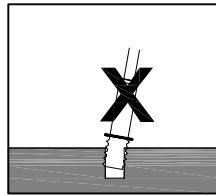
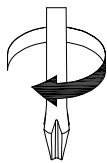

Ax12

# STEP 9

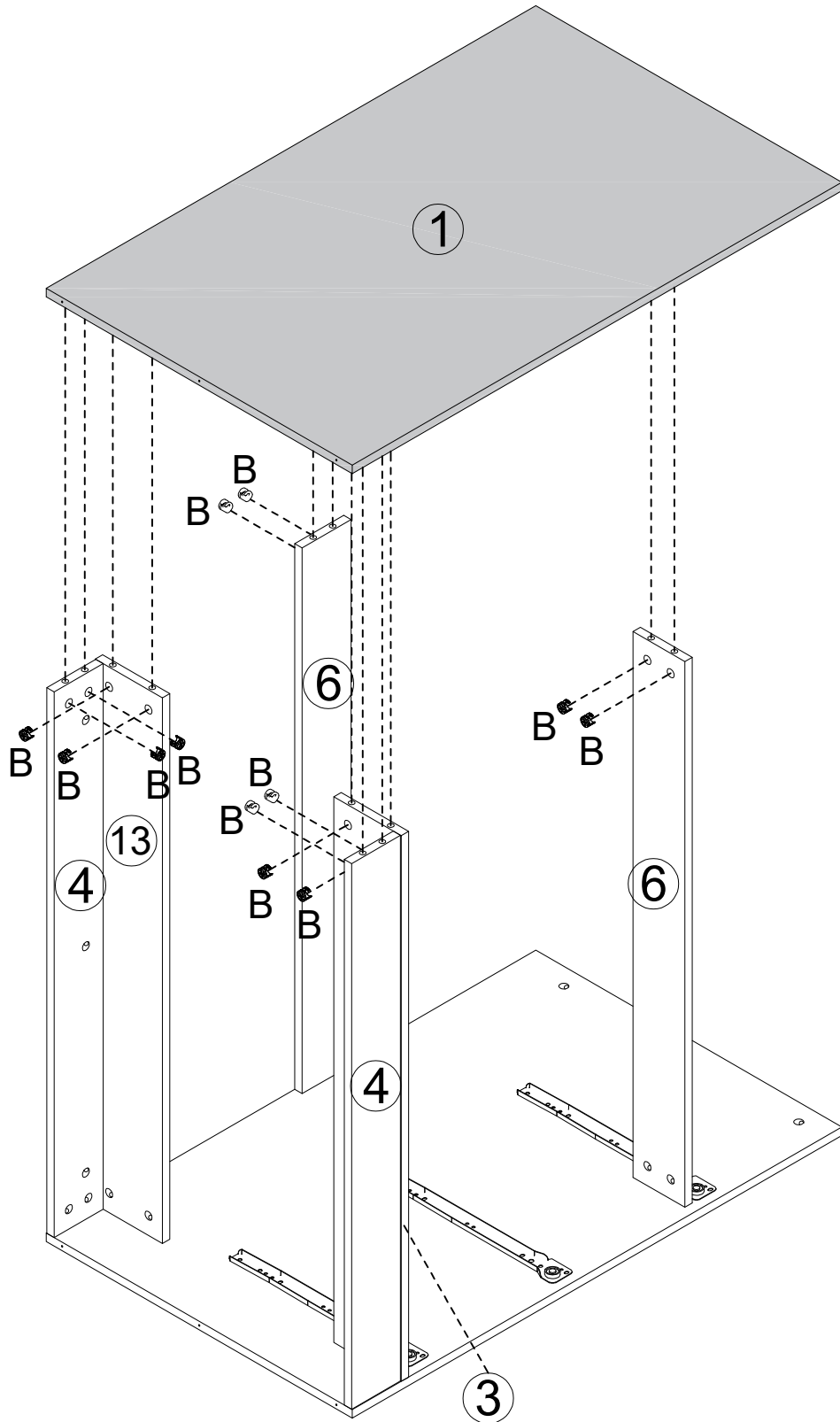
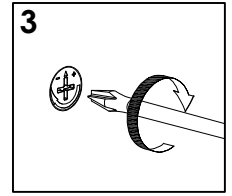
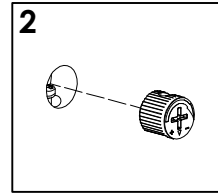
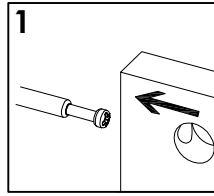
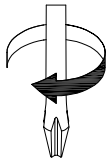

Bx12

# STEP 10

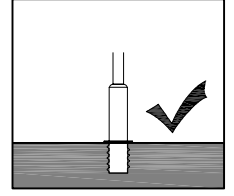
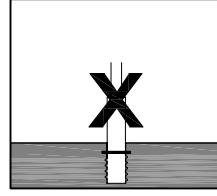
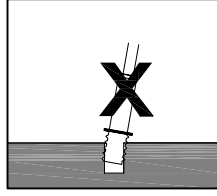
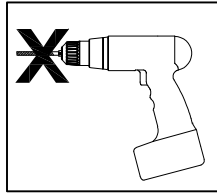

Iron Rod A is prohibited from using an electric drill.

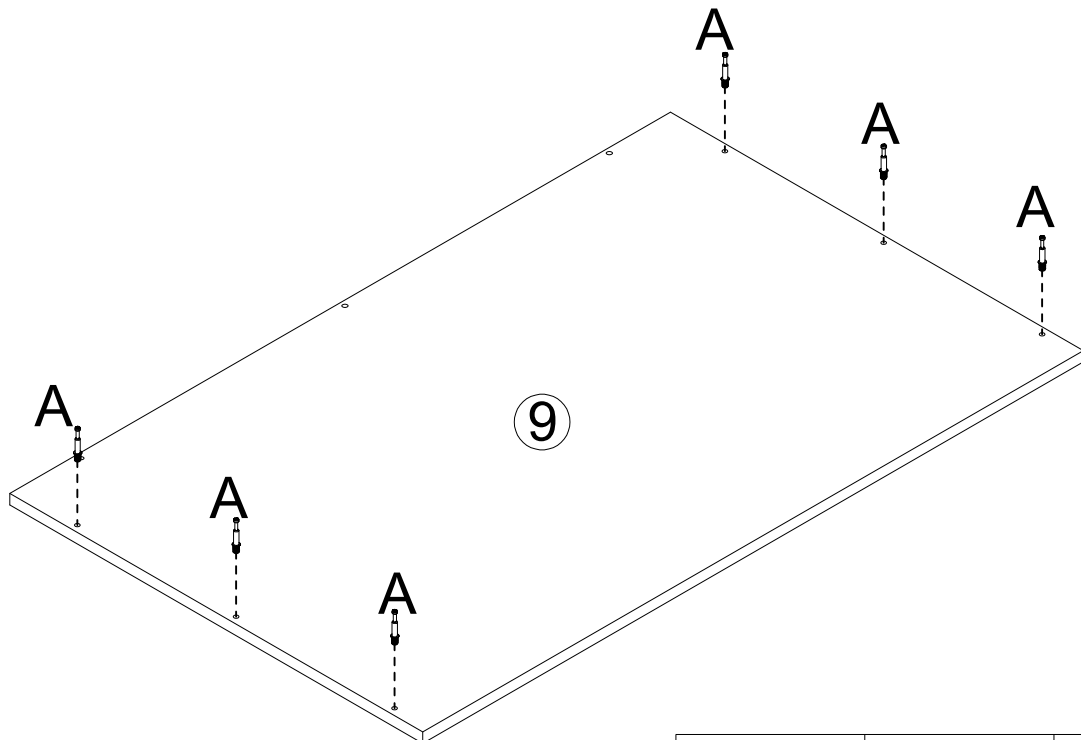
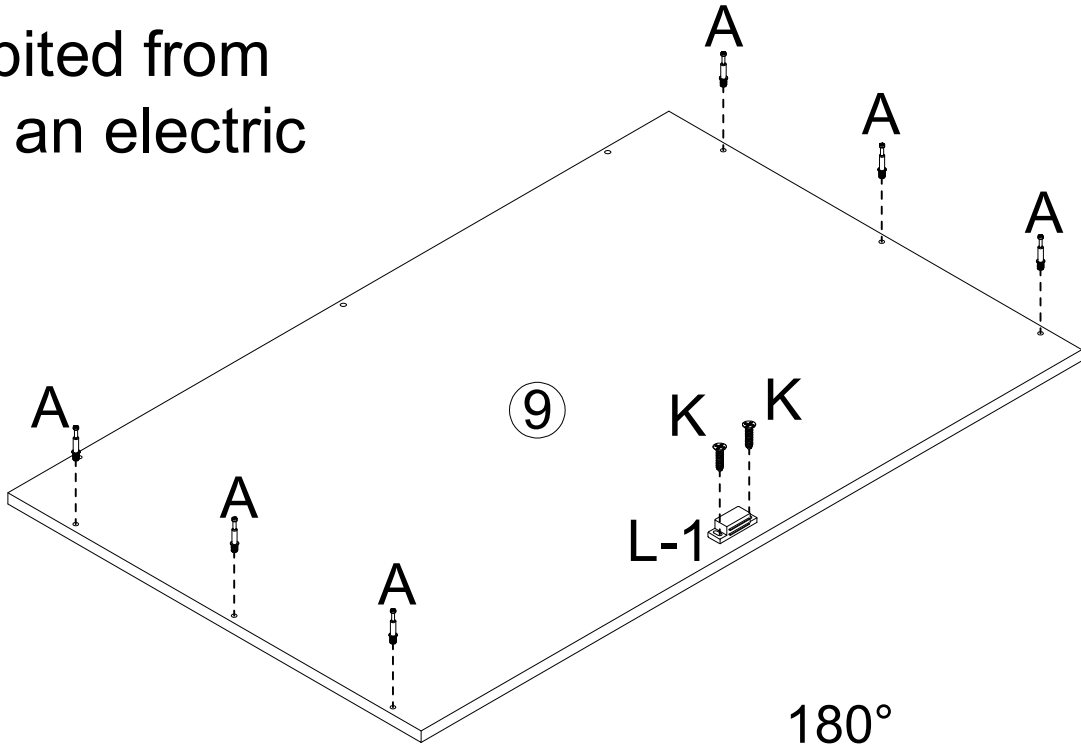
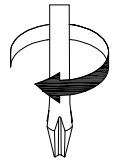

Ax12	Kx2	L-1x1
------	-----	-------

# STEP 11

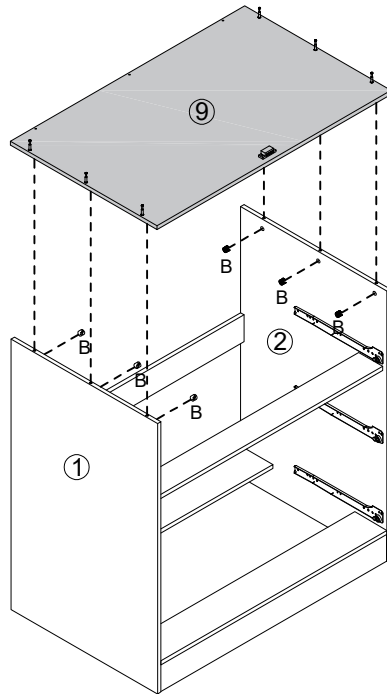
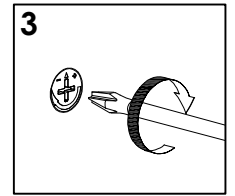
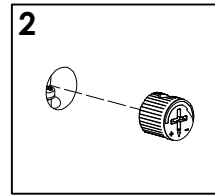
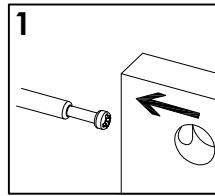
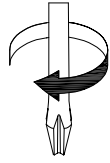

Bx6

# STEP 12

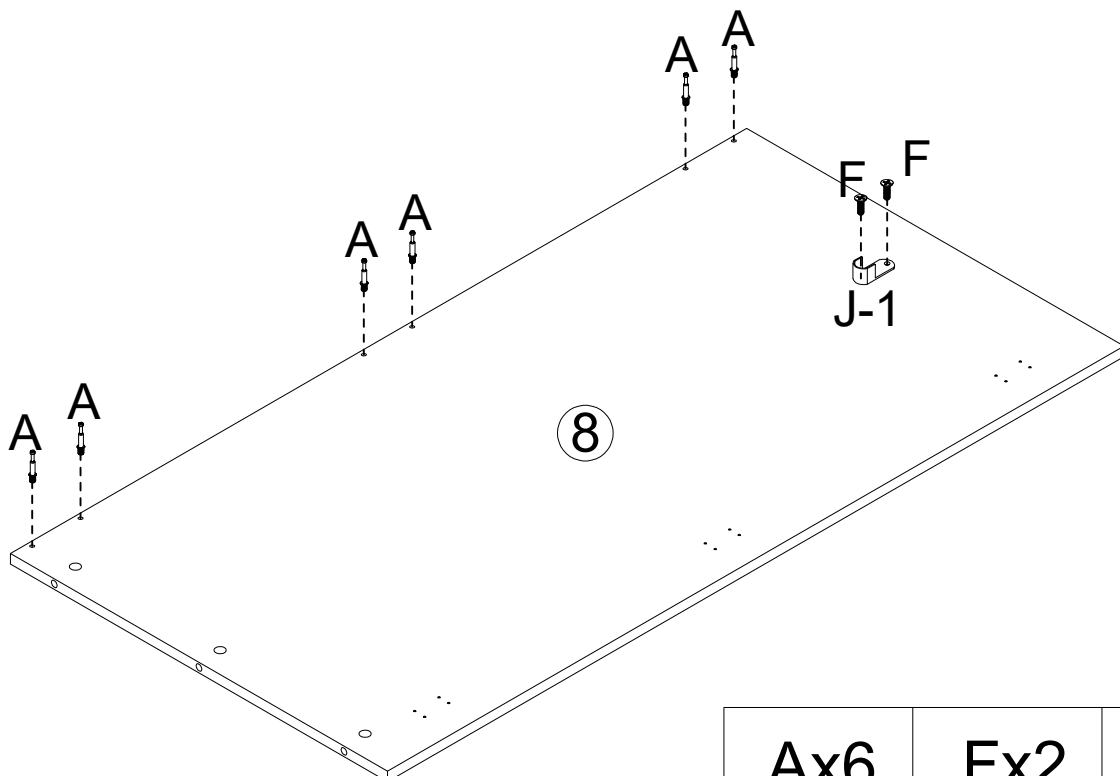
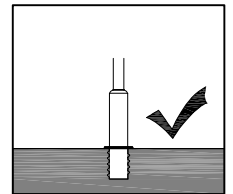
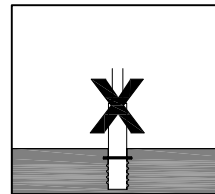
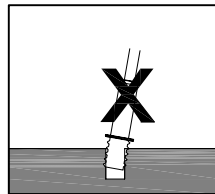
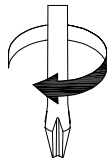

Ax6

Fx2

J-1x1

# STEP13

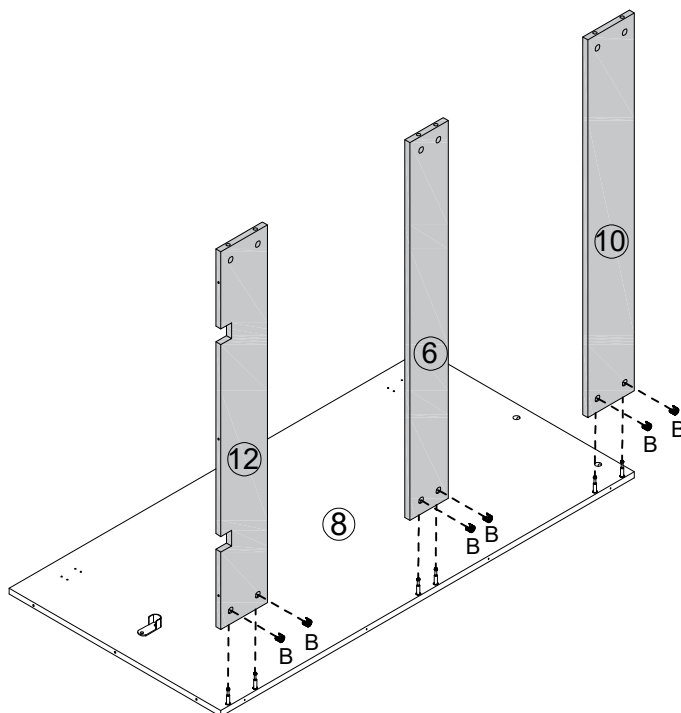
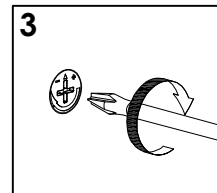
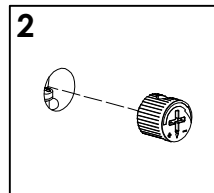
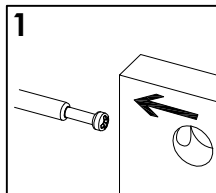
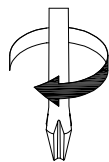

Bx6

# STEP14

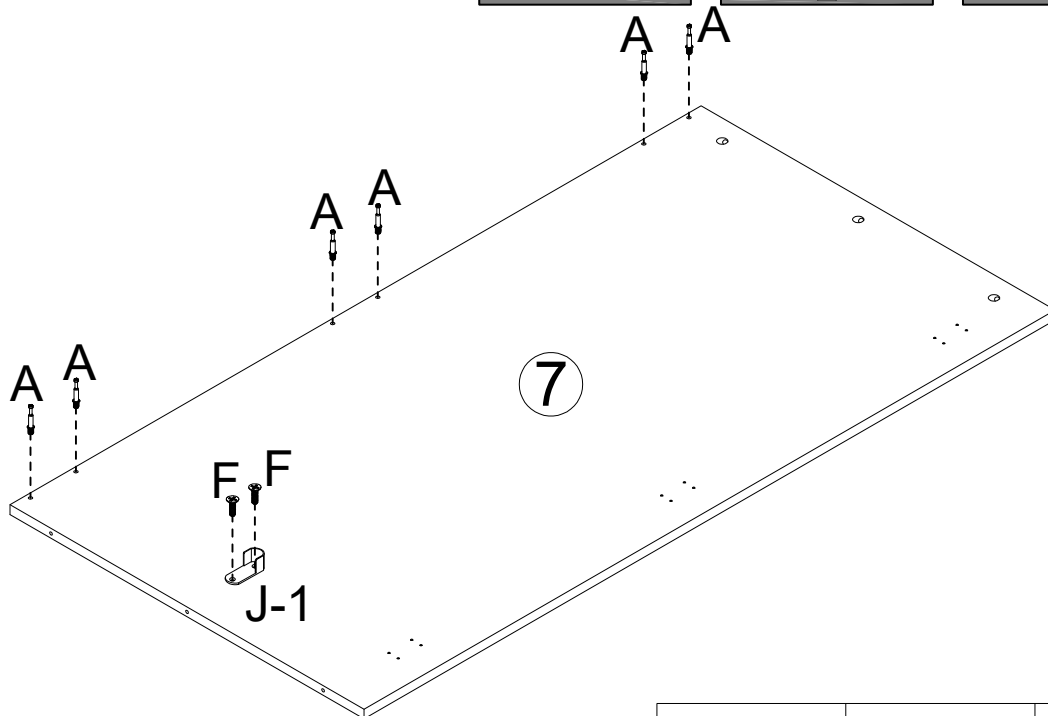
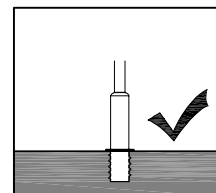
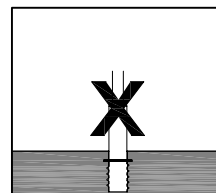
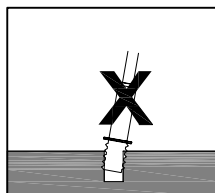
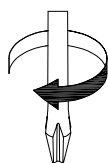

Ax6

Fx2

J-1x1

# STEP15

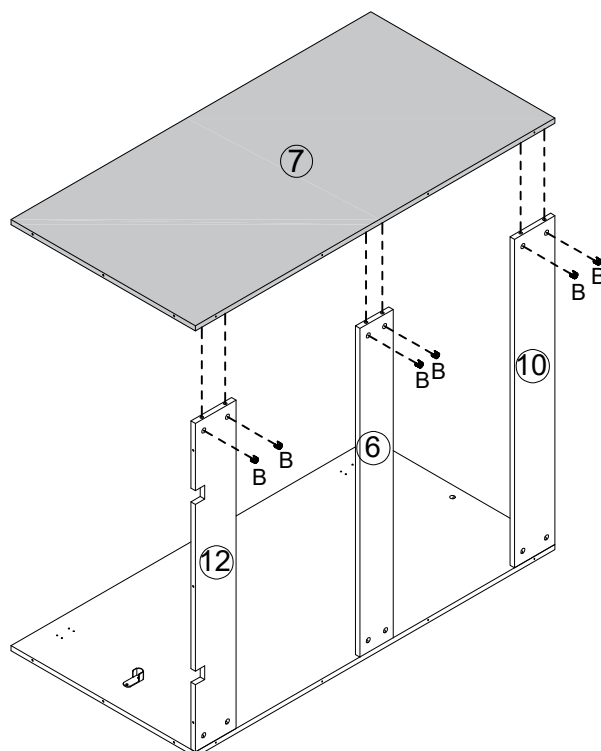
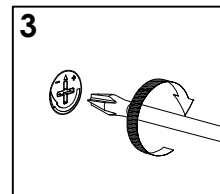
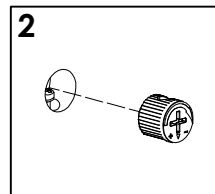
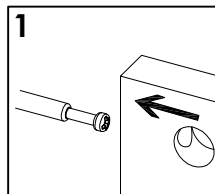
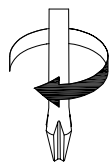

Bx6

# STEP16

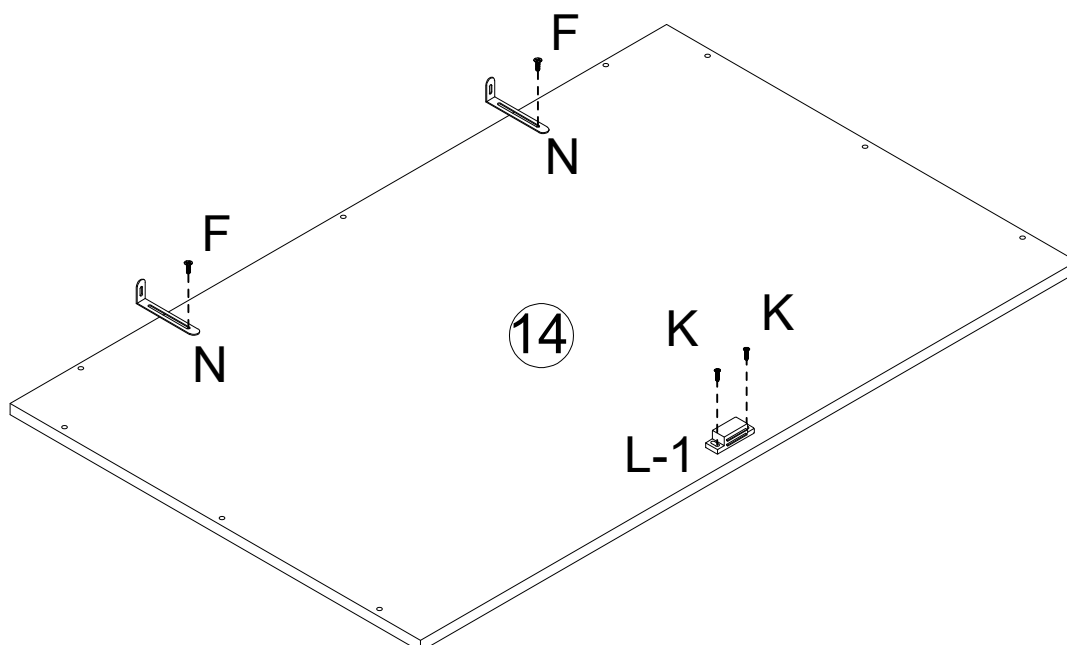
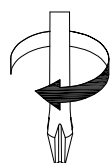

Fx2

Kx2

L-1x1

Nx2

# STEP 17

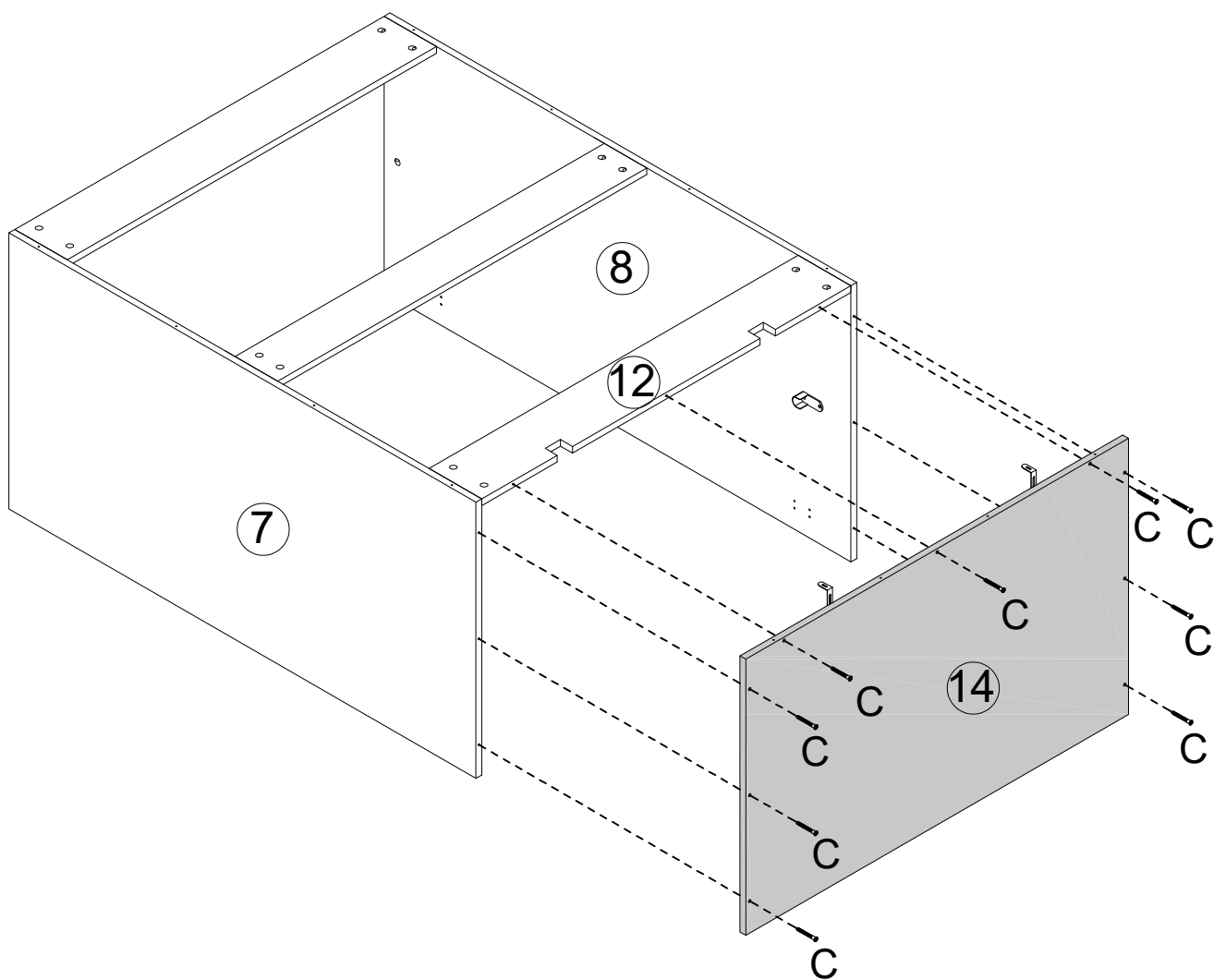
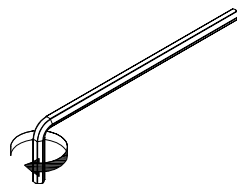
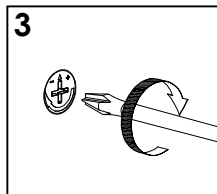
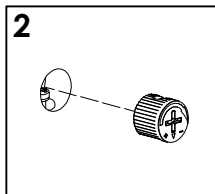
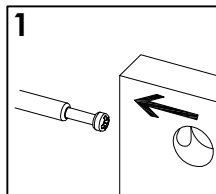
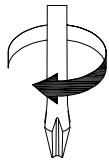

Cx9

# STEP 18

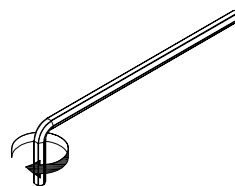
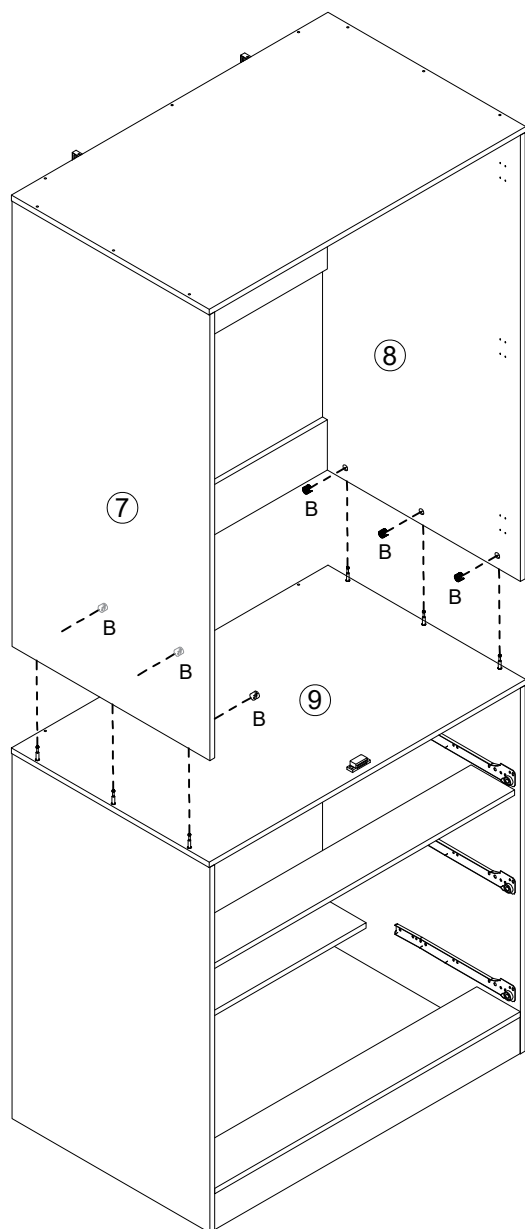
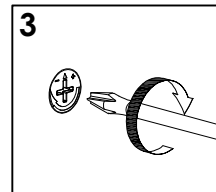
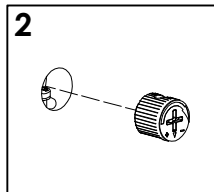
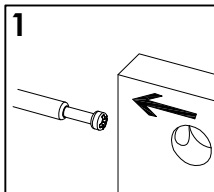
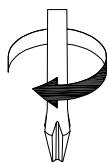

180°

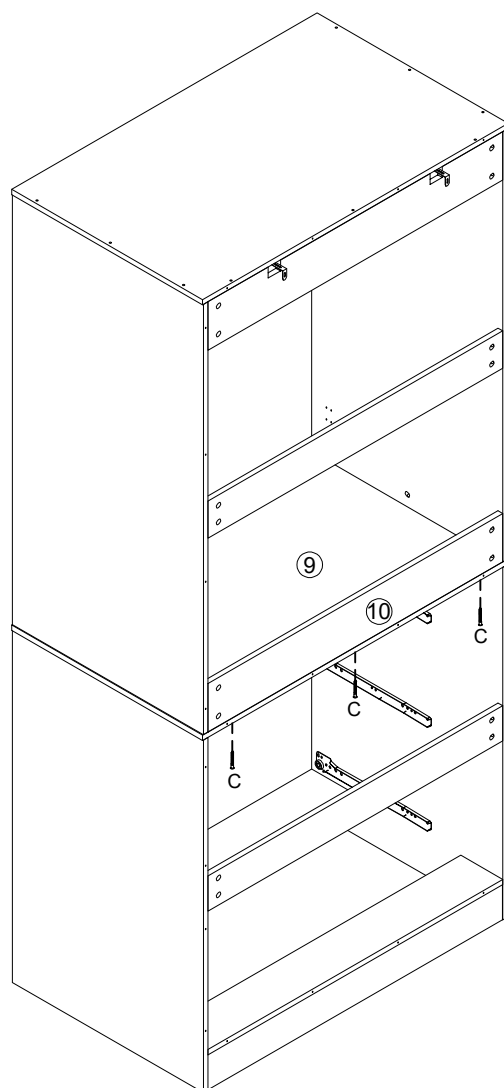

Bx6

Cx3

# STEP 19

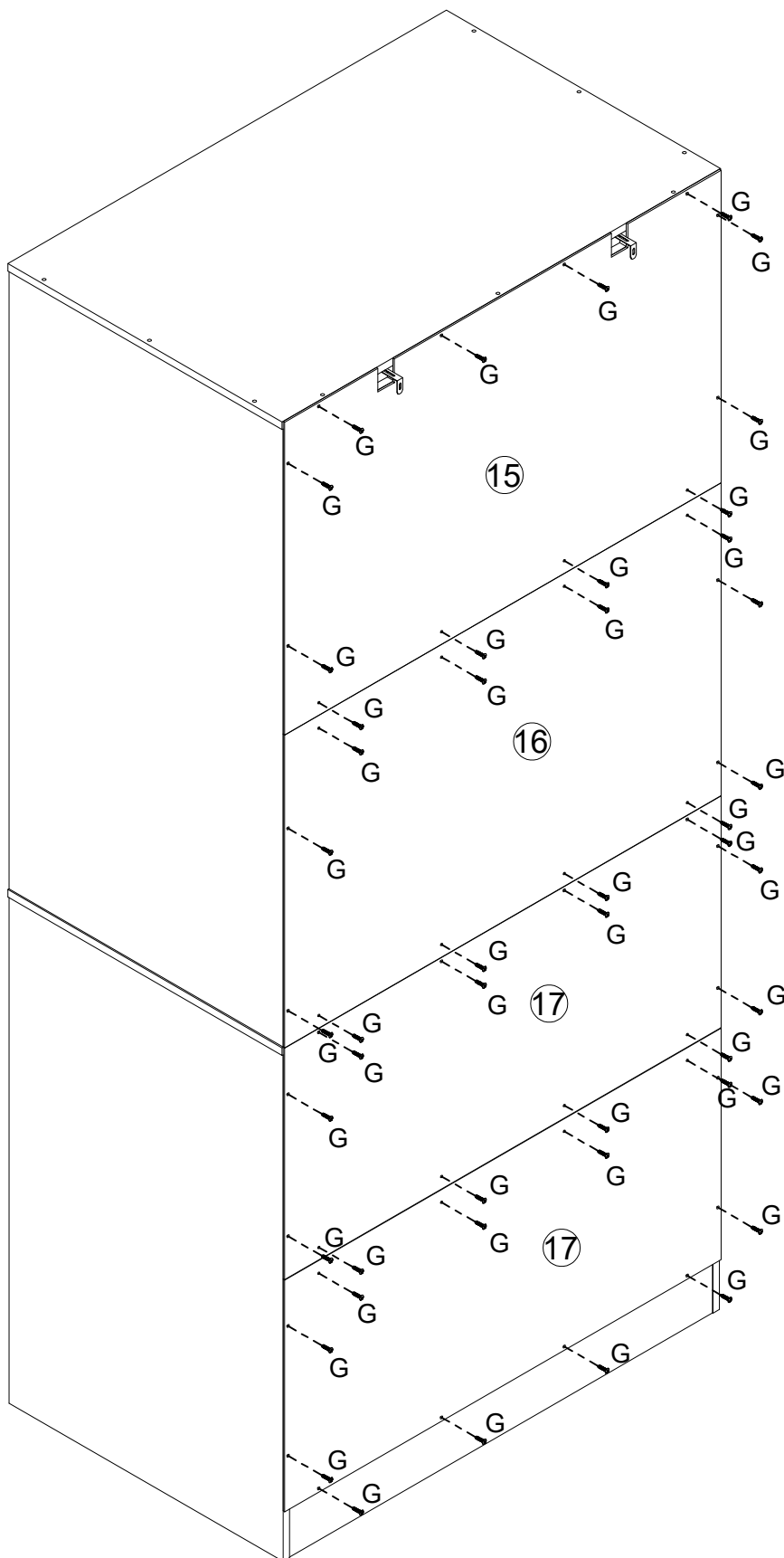
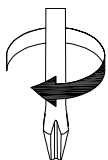

Gx48

STEP20

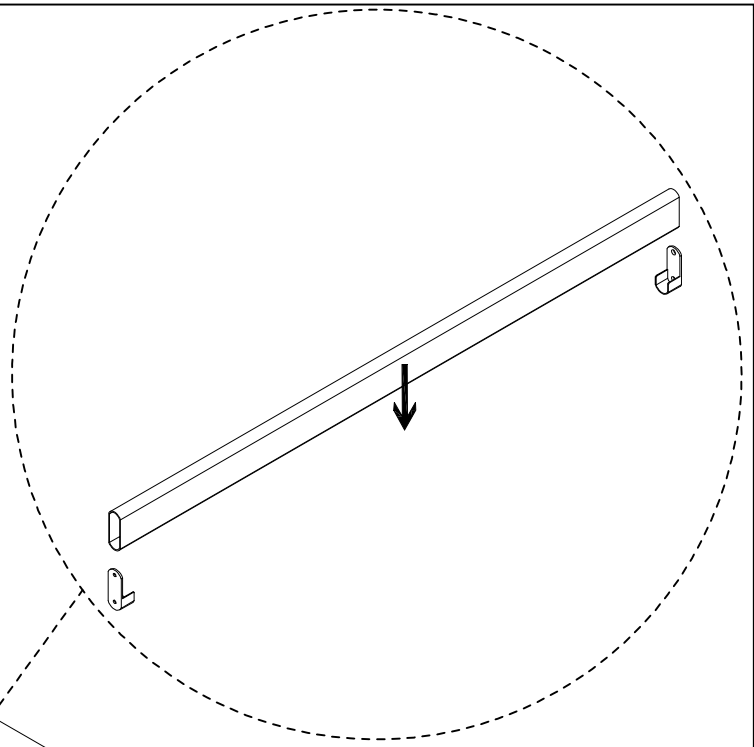
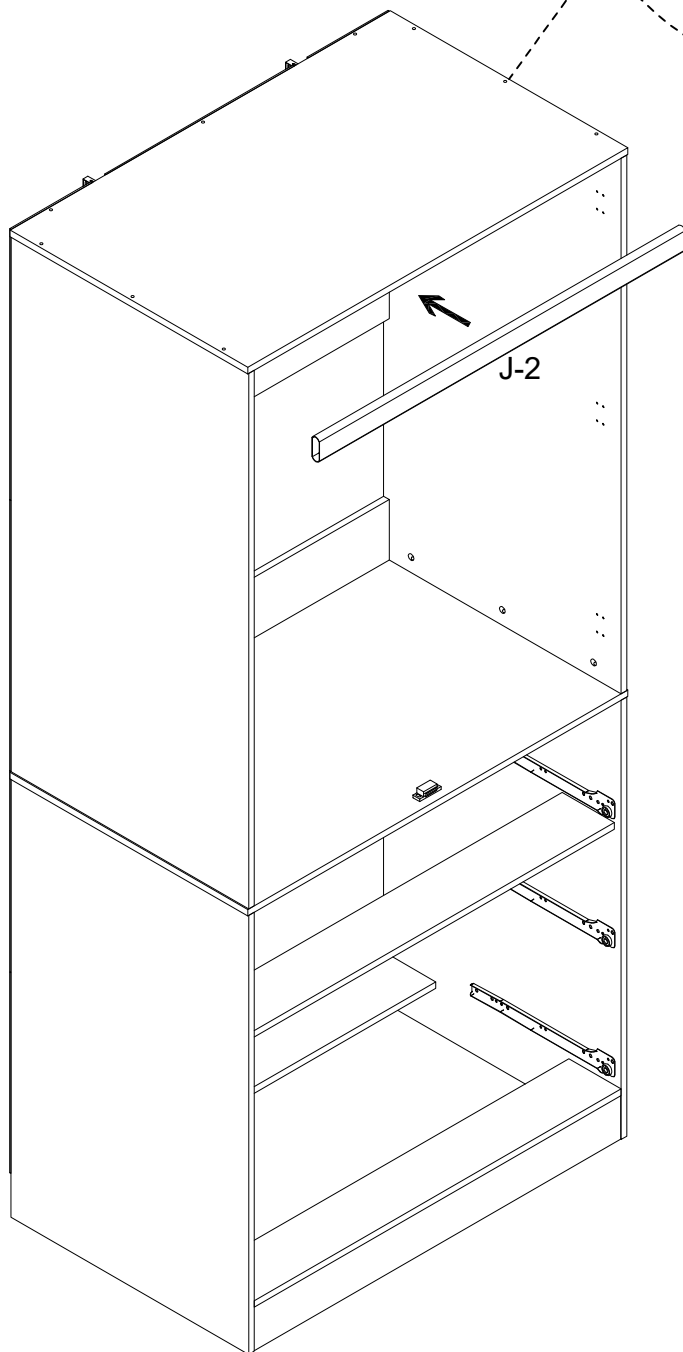

J-2x1

# STEP21

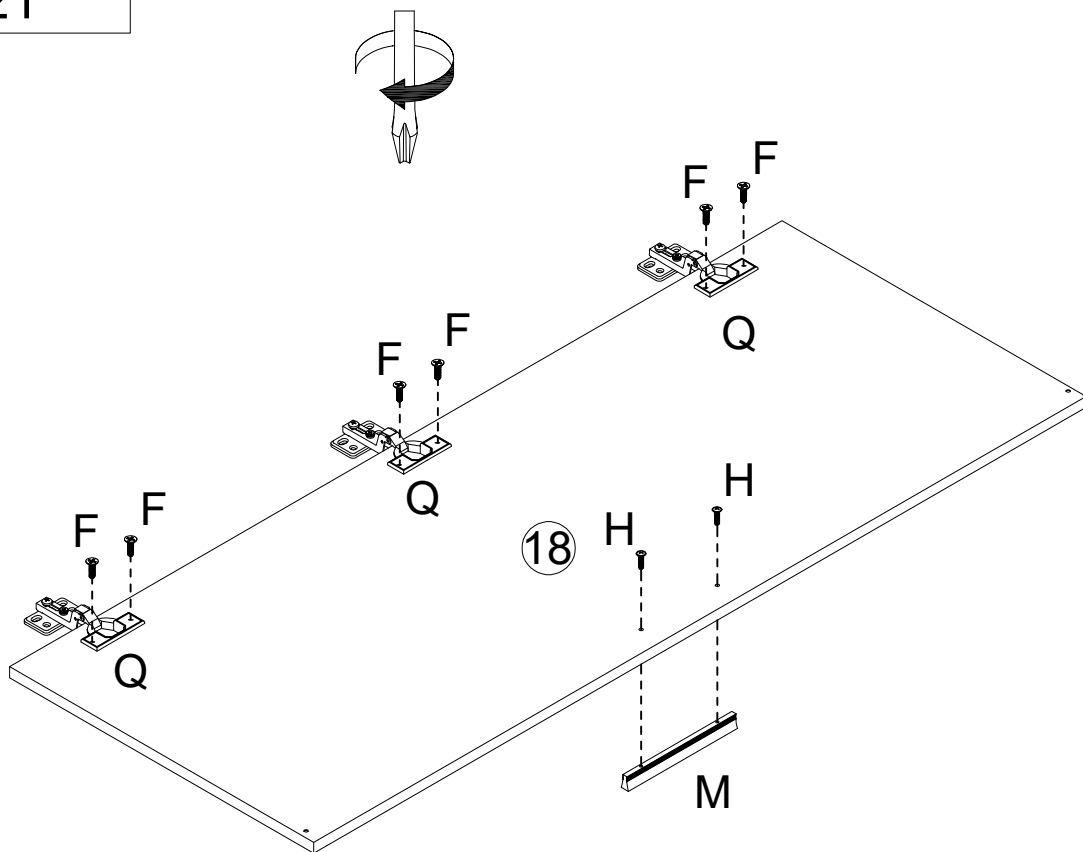

Fx6	Hx2	Mx1	Qx3
-----	-----	-----	-----

# STEP22

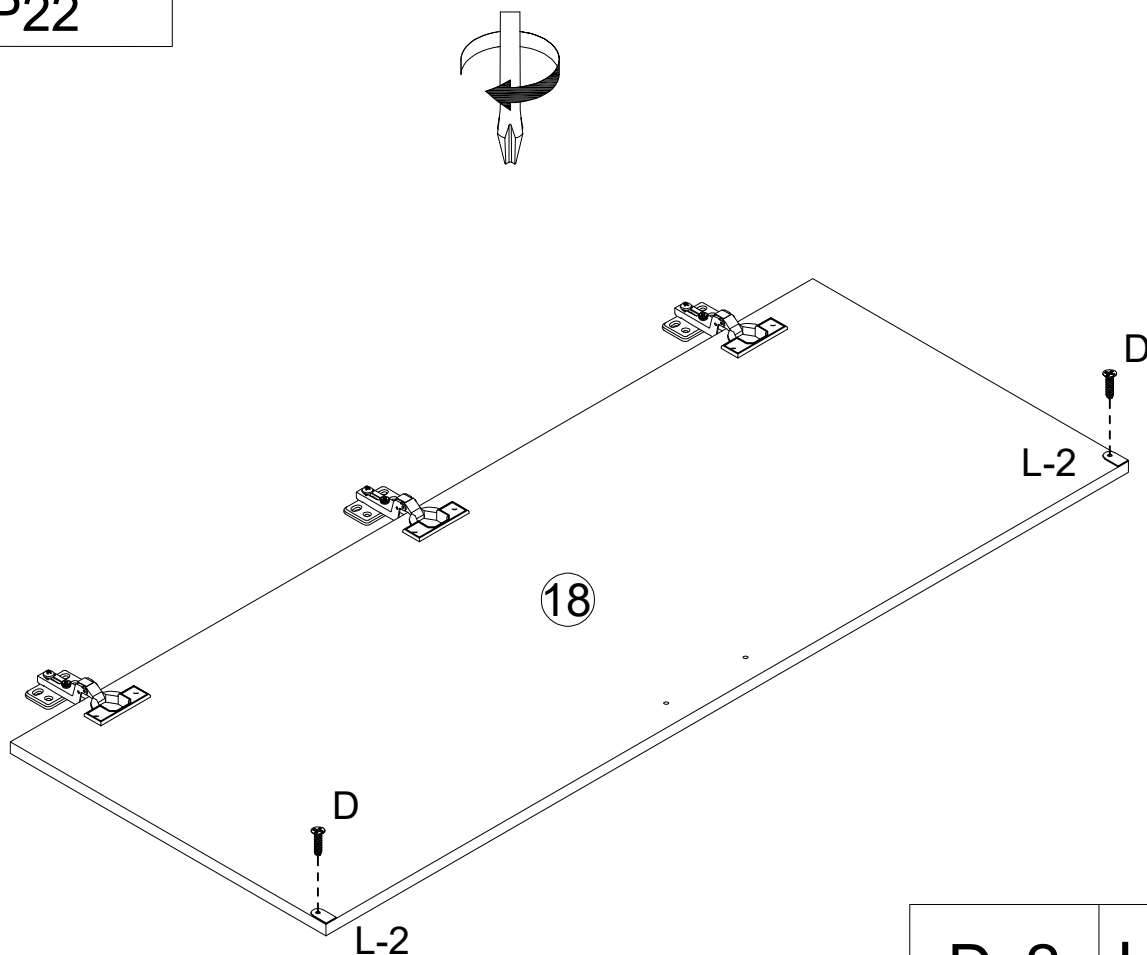

Dx2	L-2x2
-----	-------

# STEP23

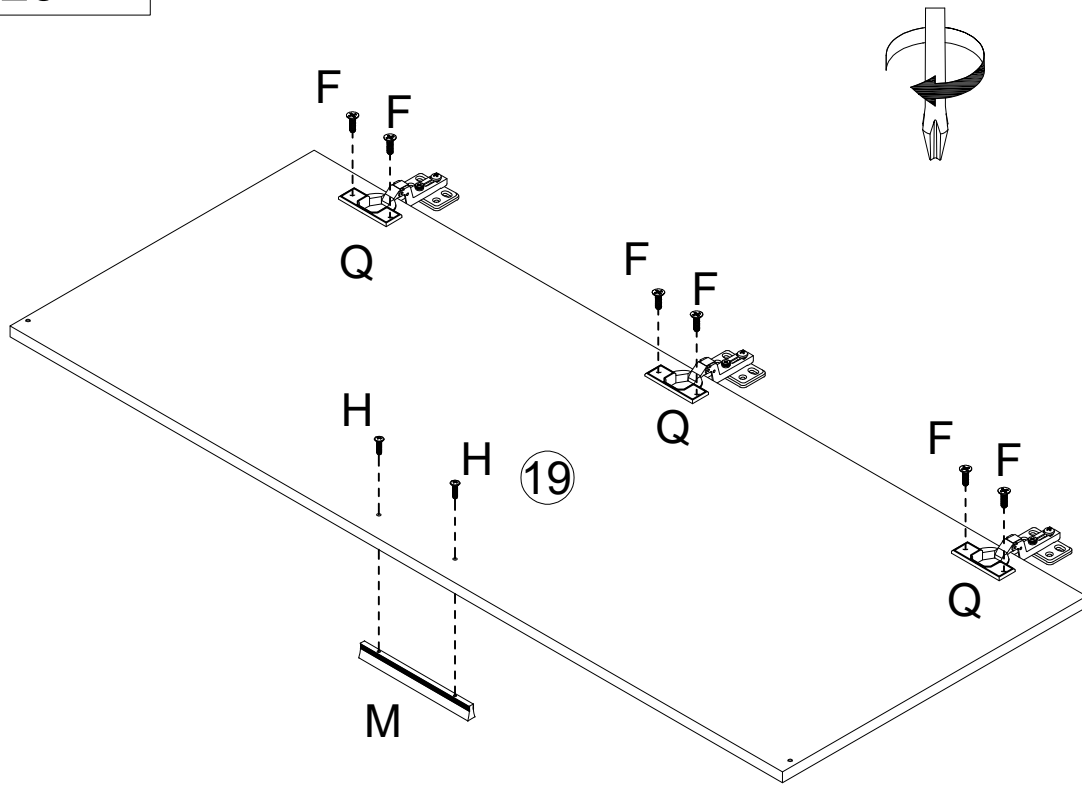

Fx6	Hx2	Mx1	Qx3
-----	-----	-----	-----

# STEP24

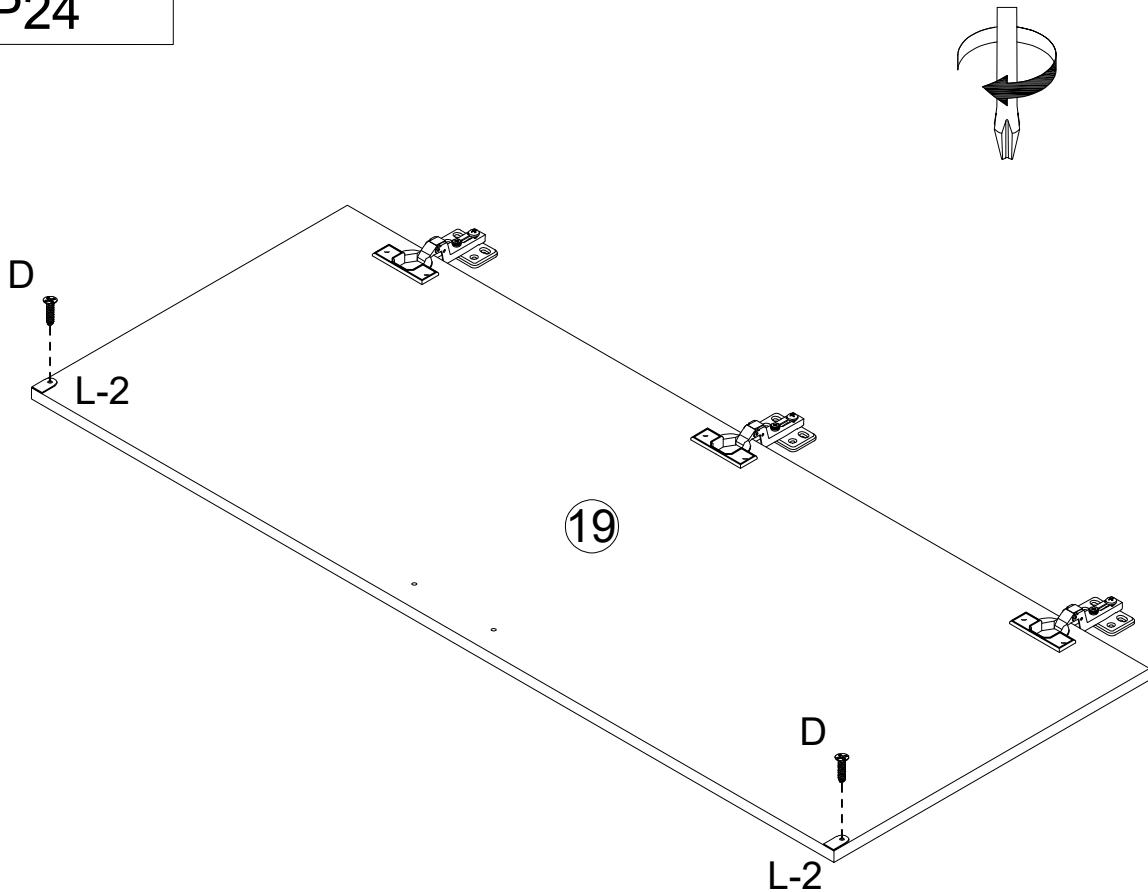

Dx2	L-2x2
-----	-------

# STEP25

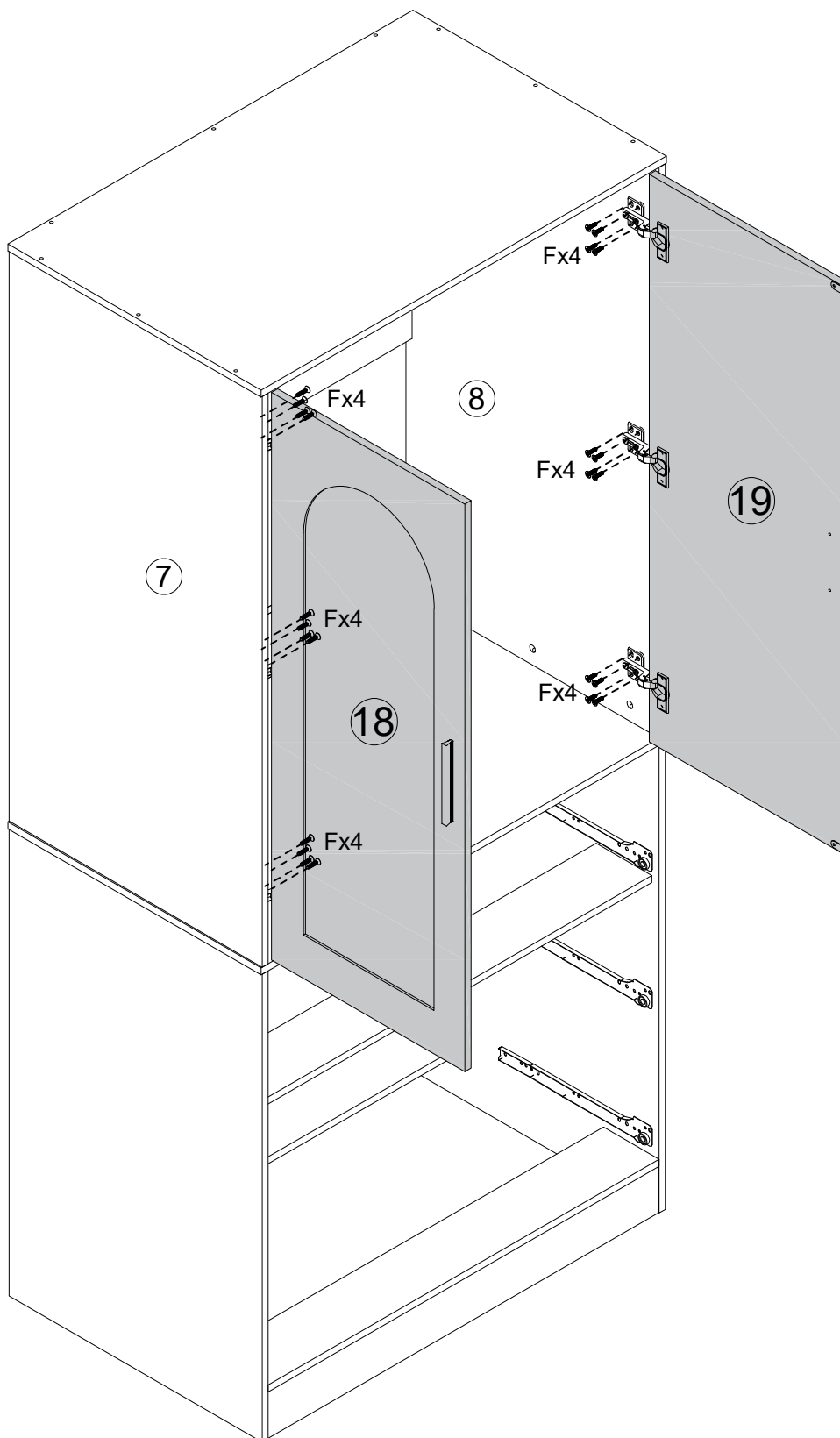
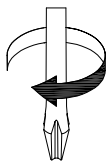

Fx24

# STEP26x3

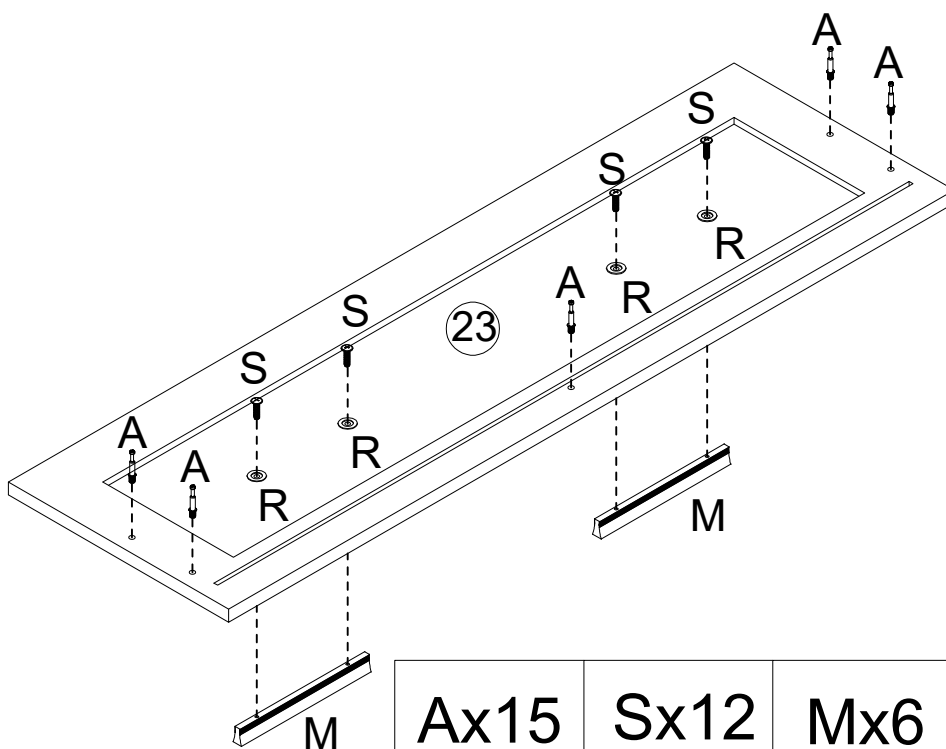
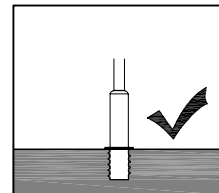
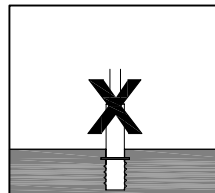
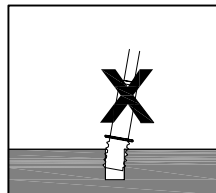
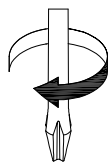

Ax15

Sx12

Mx6

Rx12

# STEP27x3

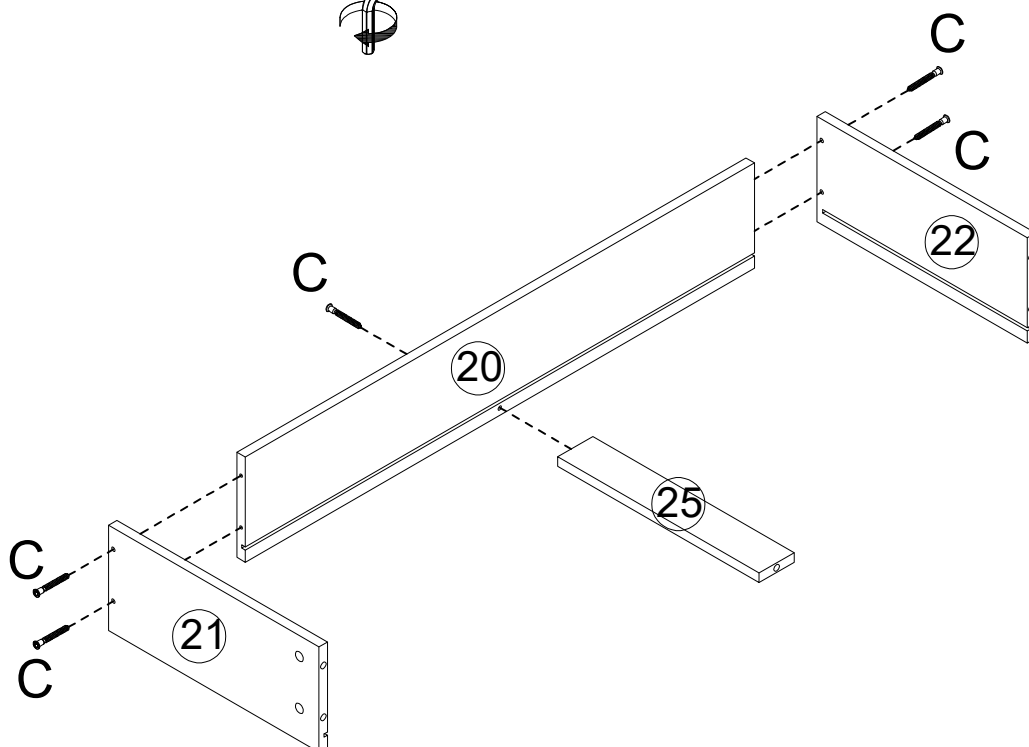
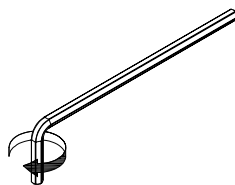

Cx15

# STEP28x3

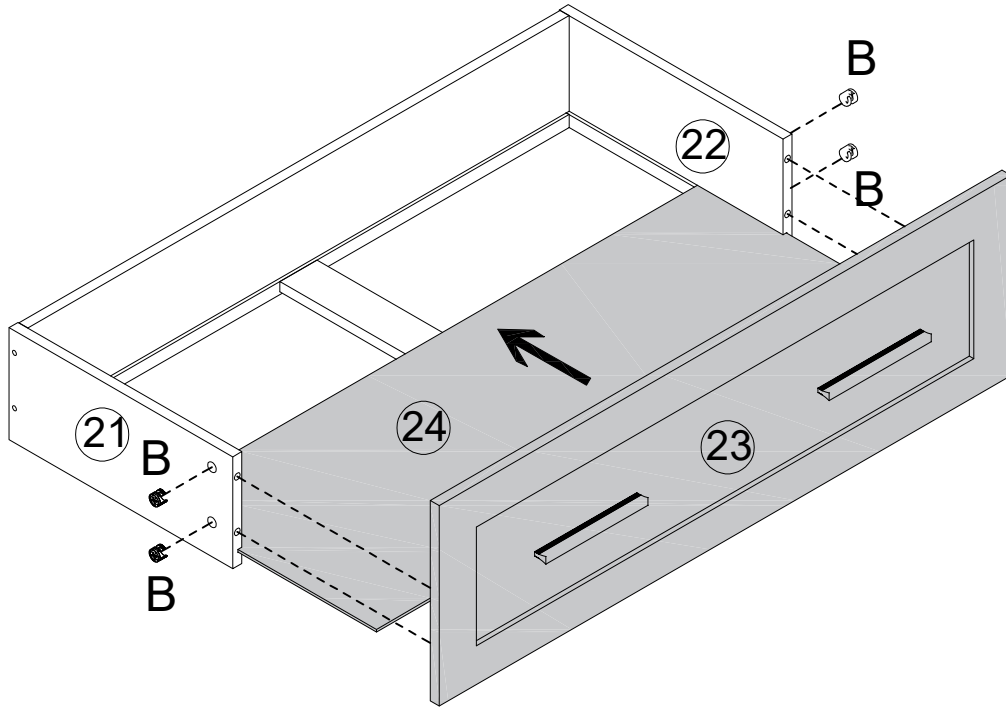
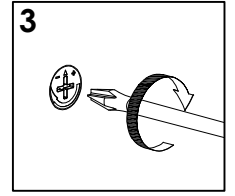
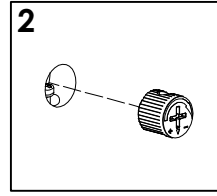
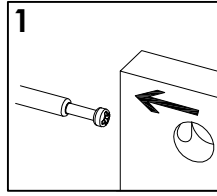
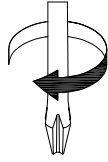

Bx12

# STEP29x3

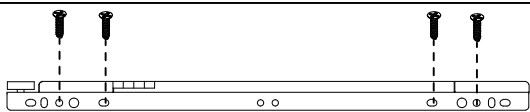
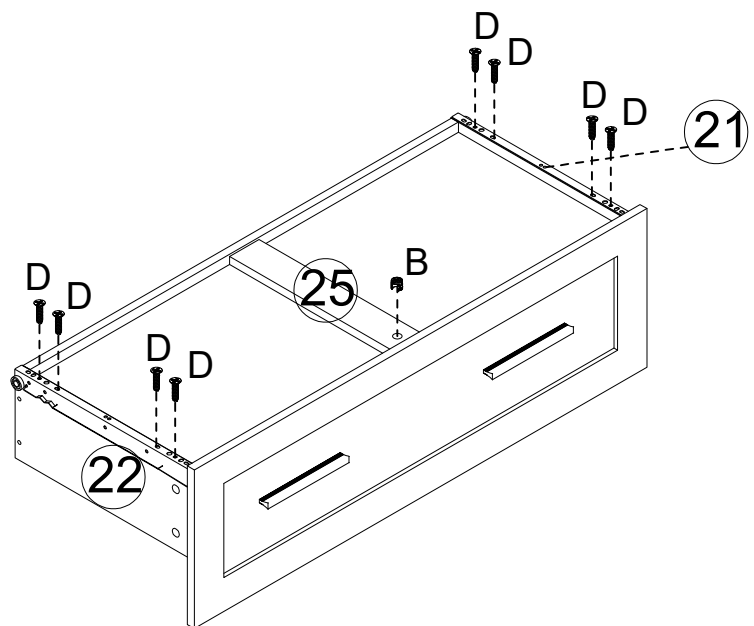
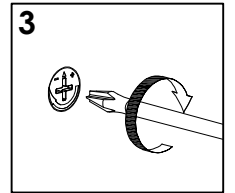
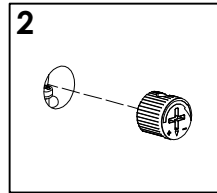
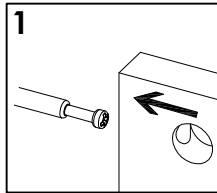
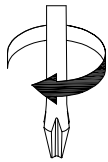

E-DLx3

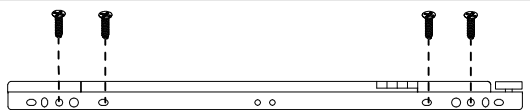

E-DRx3

Bx3

Dx24

# STEP30

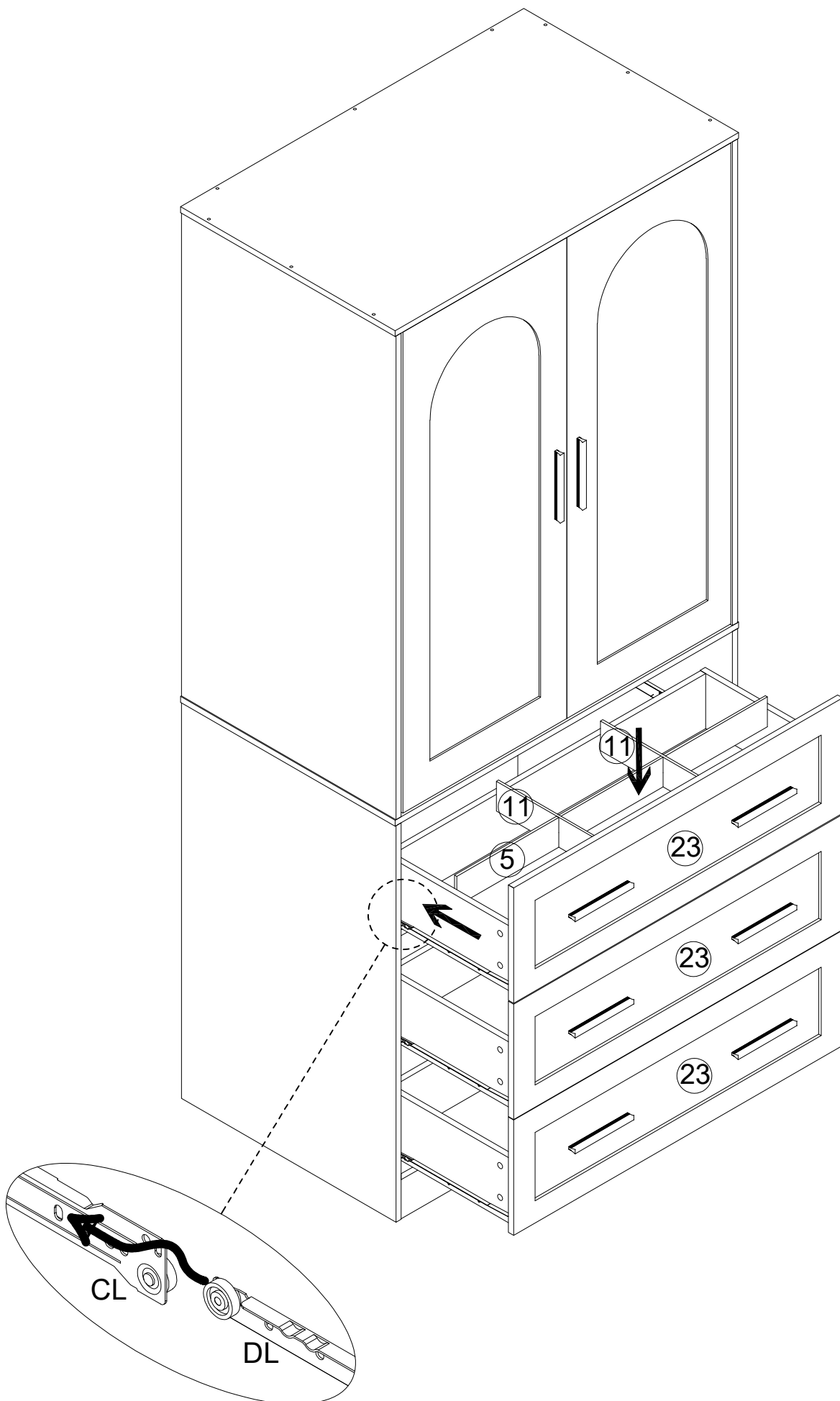

# STEP31

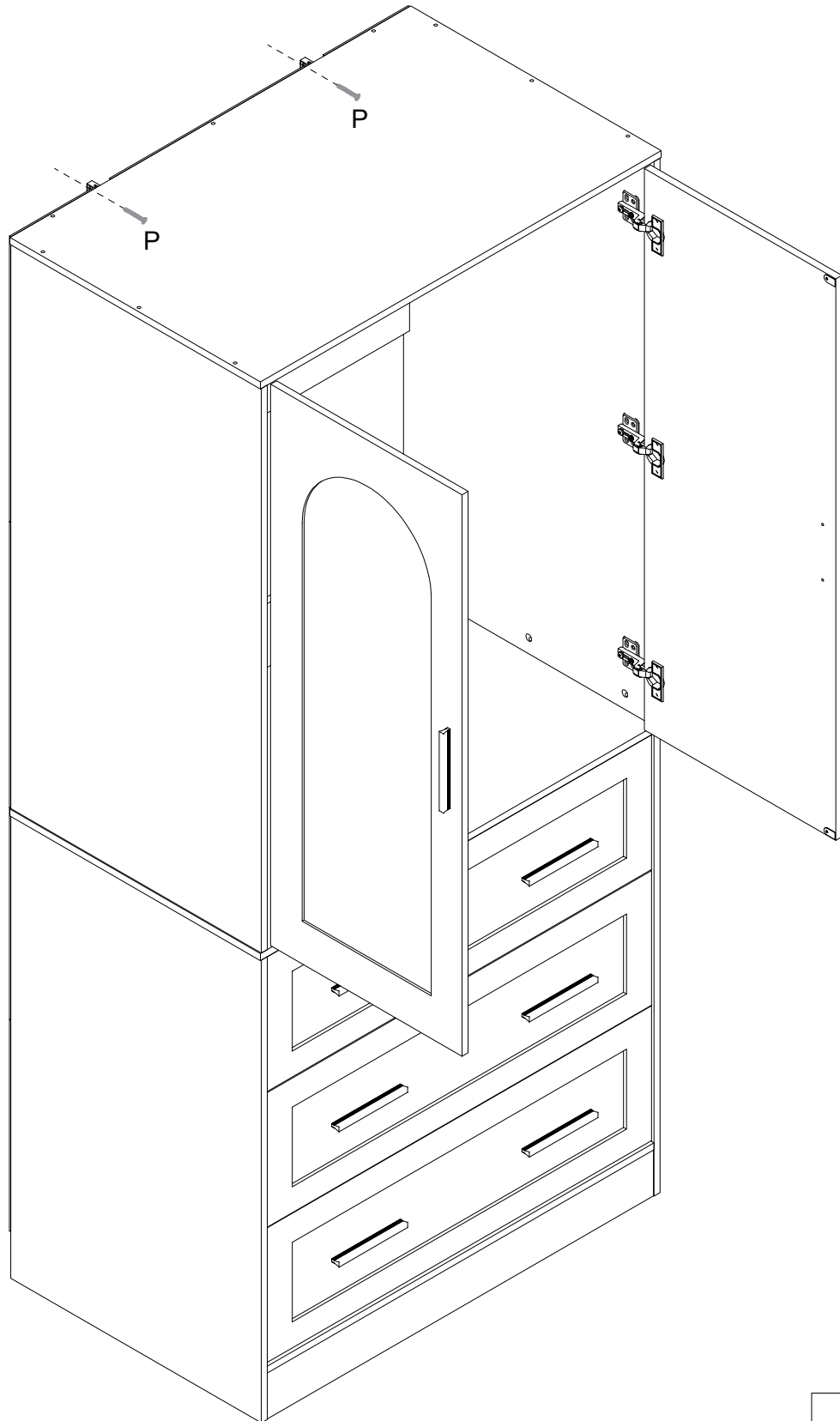
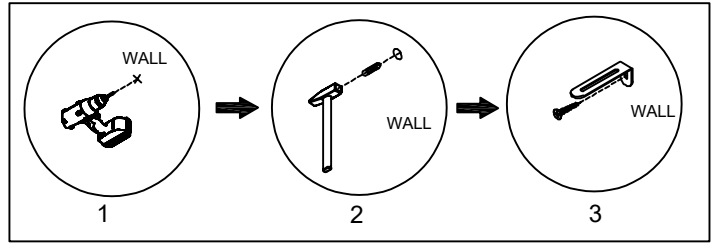
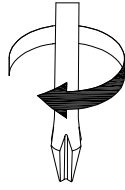

Px2