











Assembly Instructions for

PHOM 112-633A MILLBROOK WOOD SEAT
114-633A ARM CHAIR

Thank you for purchasing this quality product. Be sure to check all packing material carefully for small parts, which may have come loose inside the carton during shipment. Identify and count all parts and compare with the **HARDWARE LIST** below.

1. We recommend that you should assemble this product with the assistance of another person; this will make assembly easier, and will help to eliminate damage to the product or injury to persons during assembly.
2. Please do not over tighten screws or bolts until the assembly is completed.
3. Please put all parts on a non - abrasive floor before assembly, and follow the assembly steps to assemble your newly purchased product correctly and efficiently.

NO.	Parts List	Q' TY
A	 ChairBack	1
B	 ChairSeat	1
C	 Front Leg	2
D	 Left Arm	1
E	 Right Arm	1

NO.	Hardware list	Q'TY
1	 5/16"*3" Allen Bolts	4
2	 5/16"*2-5/32" Allen Bolts	4
3	 5/16"*1-3/8" Allen Bolts	4
4	 1/4"*1-1/2" Allen Bolts	2
5	 Spring Washers (8mm)	12
6	 Flat Washers (8*19*2mm)	12
7	 Allen Key (4mm)	1
8	 Wood Plug (φ16*10mm)	2

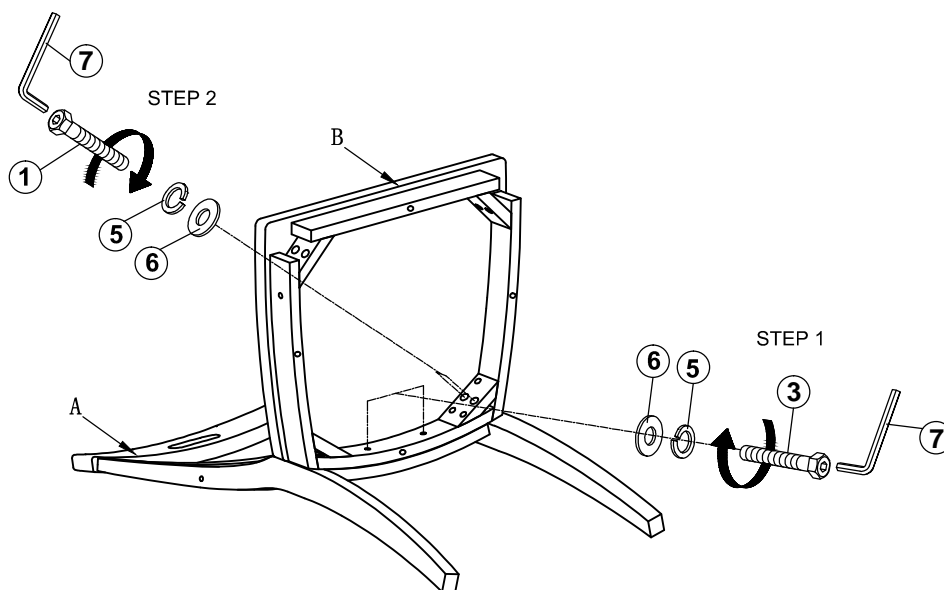

MADE IN VIETNAM

