









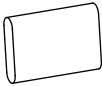

## CARE AND MAINTENANCE

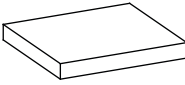
Spot clean using a mild water-free solvent. Only a professional cleaner should undertake a complete overall cleaning.  
The use of steam or water-based cleaners may cause excessive shrinking or staining.

## NOTICE

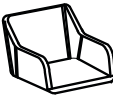
- \* Please make sure all parts are included before you begin assembly of this item.
- \* This item should be assembled on a soft surface to prevent scratching the finish during assembly
- \* This item may require periodic tightening

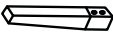
### Parts List and Hardware List

ID	PICTURE & DESCRIPTION	Q.tys	ID	PICTURE & DESCRIPTION	Q.tys
a		32X	6		4X
b		32X	7		4X
c		1X	8		1X
1		6X	9		2X
2		6X			
3		4X			
4		1X			
5		1X			

Product dimension:

Bench: 53W x 27D x 28.5H (Inches)  
Chair: 25W x 27D x 28.5H (Inches)  
Table: 41.5W x 21.3D x 14.2H (Inches)

### ASSEMBLY INSTRUCTIONS

THE DESIGN OF THE DRAWINGS MAY VARY FROM ACTUAL, BUT  
ASSEMBLY CAN BE APPLIED  
FOR THIS ITEM

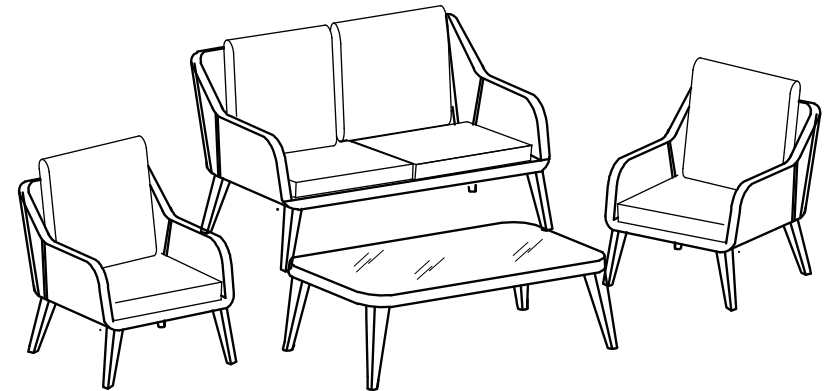

Weight Capacity: 704 lbs per bench & 55 lbs per table

WARNING: DO NOT STAND ON BENCH & TABLE

WARNING: DO NOT OVER TORQUE BOLTS/SCREWS

## PREPARATION

Before beginning assembly of product, make sure all parts are present. Compare parts with package contents list and hardware contents list. If any part is missing or damaged, do not attempt to assemble the product.

Estimated Assembly Time: 10 minutes.

Tools Required for Assembly: Allen Key (included)

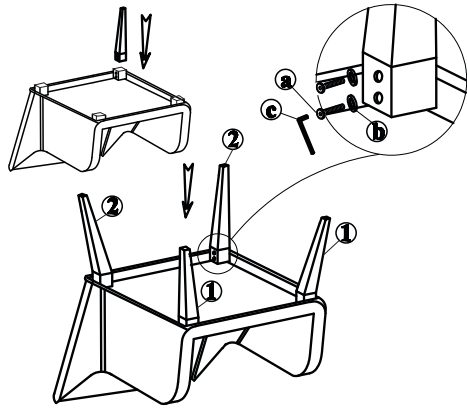

Tighten 70%

Step 1: Attach wood leg (1 & 2) to front and back of the chair respectively, using a & b. Loosen the bolt to balance the chair first

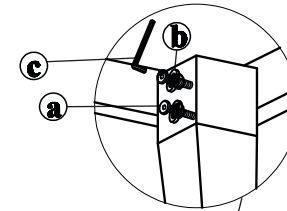

Tighten 100%

Step 2: Fully tighten using Key (c)

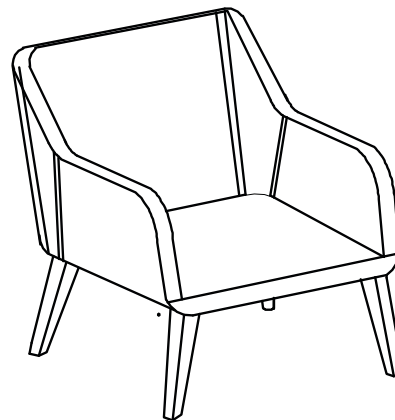

## PREPARATION

Before beginning assembly of product, make sure all parts are present. Compare parts with package contents list and hardware contents list. If any part is missing or damaged, do not attempt to assemble the product.  
Estimated Assembly Time: 10 minutes.

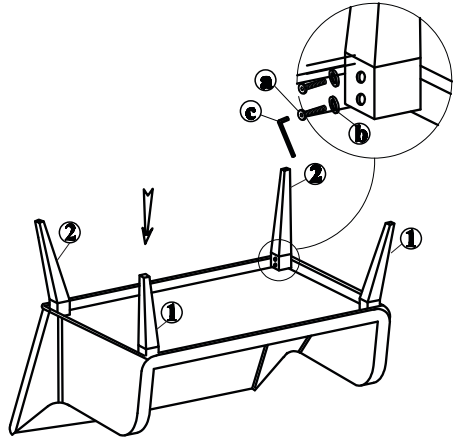

Tighten 70%

Step 1: Attach wood leg (1 & 2) to front and back of the bench respectively, using a & b. Loosen the bolt to balance the bench first

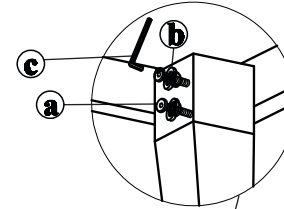

Tighten 100%

Step 2: Fully tighten using Key (c)

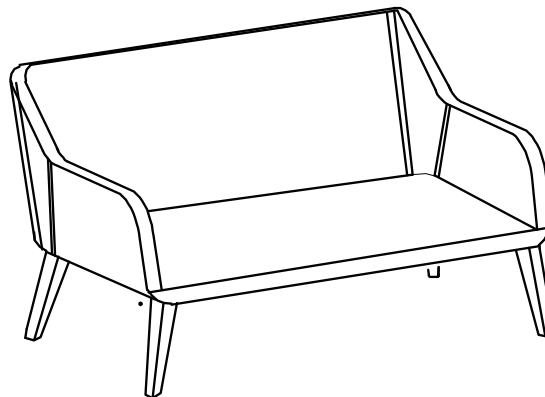

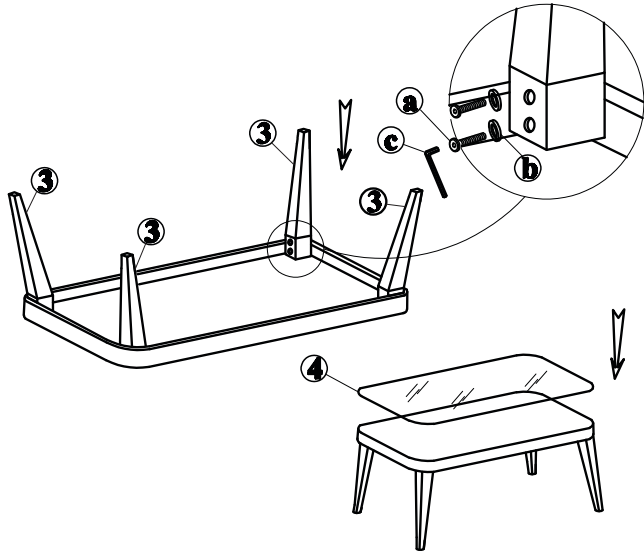

Step 1: Attach wood leg (3) to frame, using a & b. Loosen the bolt to balance the table first

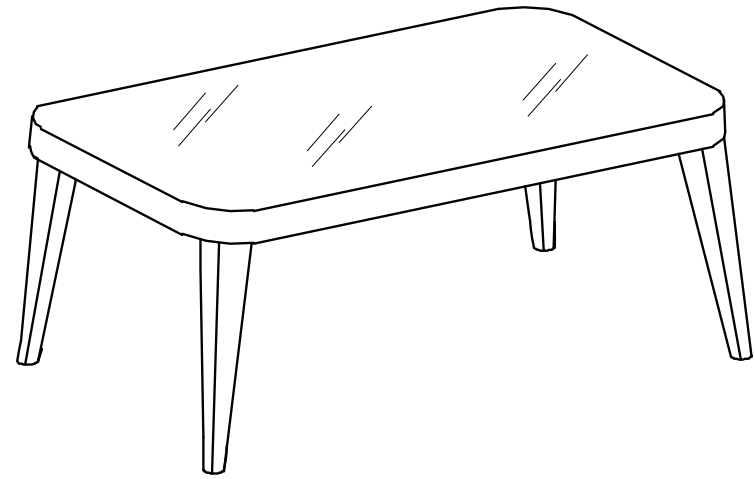

Step 2: Fully tighten using Key (c) after that put the glass on top table

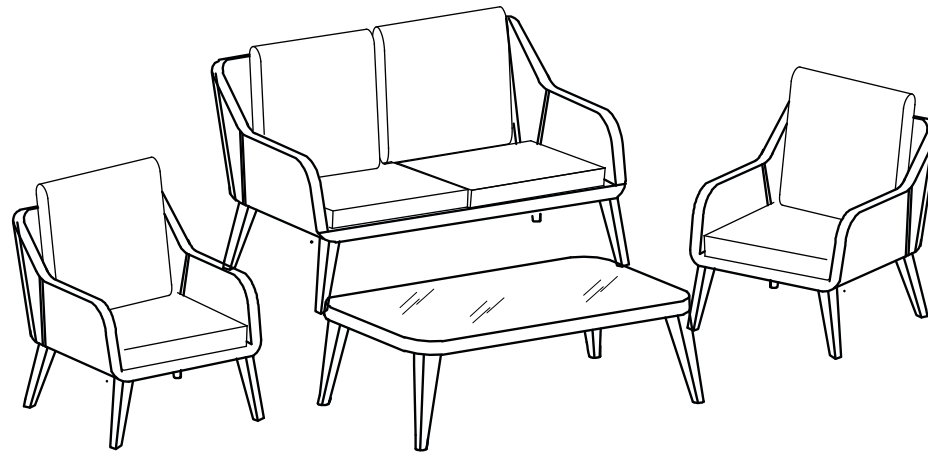

Step 3: Put all cushions on the chairs and bench