

# Assembly Instructions

**Caution: You must read this before you proceed**

## QUEEN SIZE BED

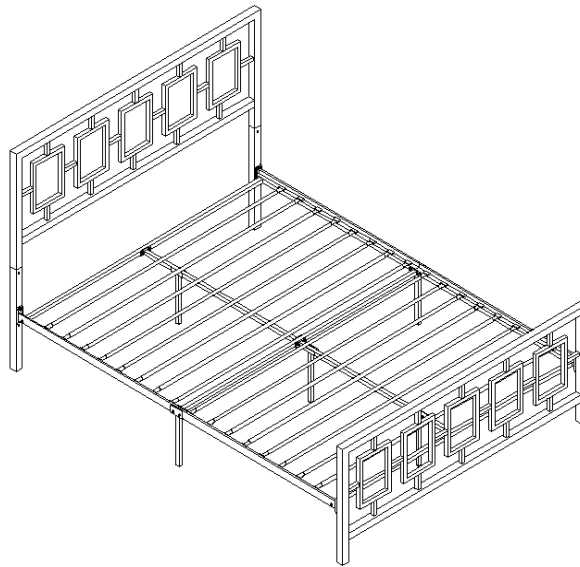

**WARNING**  
**STRANGULATION HAZARD.**

NEVER place bed near windows where cords from blinds or drapes may strangle a child.

NEVER suspend strings over bed.

NEVER place items with a string, cord, or ribbon, such as hood strings or pacifier cords, around a child's neck.

These items may catch on bed parts.





ALWAYS follow assembly instructions.

**WARNING!**

Not intended for children under the age of six. **INFANTS HAVE DIED FROM BECOMING ENTRAPPED IN BEDS.** Openings in and between bed parts can entrap the neck and head of a small child. NEVER use bed for child under the age of six.

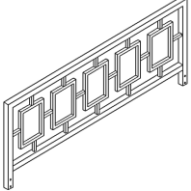
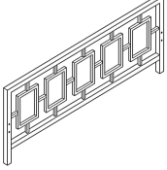
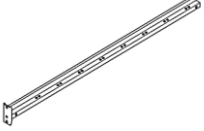
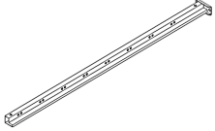



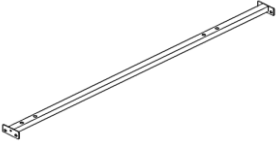
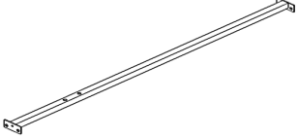

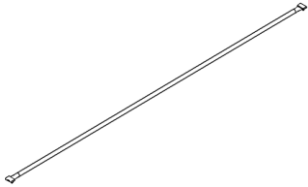
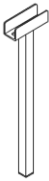

The mattress must be appropriately sized for the bed. If the mattress is undersized, dangerous gaps can exist and a person can become entrapped or entangled in the frame and suffocate.

# Parts List

| Label | Picture                                                                             | Description                | QTY |
|-------|-------------------------------------------------------------------------------------|----------------------------|-----|
| A     |    | Headboard Foot             | 2   |
| B     |    | Headboard                  | 1   |
| C     |    | Footboard                  | 1   |
| D     |    | Side Rail(Labelled 'D')    | 2   |
| E     |  | Side Rail(Labelled 'E')    | 2   |
| F     |  | Rail Support Leg           | 2   |
| G     |  | Support Rail               | 2   |
| H     |  | Cross Center Support Rail  | 1   |
| I     |  | Vertical Front Center Rail | 1   |
| J     |  | Vertical Rear Center Rail  | 1   |

|   |                                                                                   |                    |    |
|---|-----------------------------------------------------------------------------------|--------------------|----|
| K |   | Slat               | 16 |
| L |  | Center Support Leg | 3  |

## Hardware

| Label | Picture                                                                             | Description          | QTY |
|-------|-------------------------------------------------------------------------------------|----------------------|-----|
| ①     |    | Bolt(M6x16mm)        | 27  |
| ②     |    | Bolt(M6x36mm)        | 3   |
| ③     |    | Bolt(M6x46mm)        | 9   |
| ④     |    | Spring Washer φ6.5mm | 9   |
| ⑤     |  | Flat Washer φ6.5mm   | 9   |
| ⑥     |  | Nut(M6)              | 7   |
| ⑦     |  | Allen Key(M6)        | 1   |
| ⑧     |  | Wrench               | 1   |
| ⑨     |  | Slat Connector       | 38  |

## Assembly Preparation

Before Beginning Assembly:

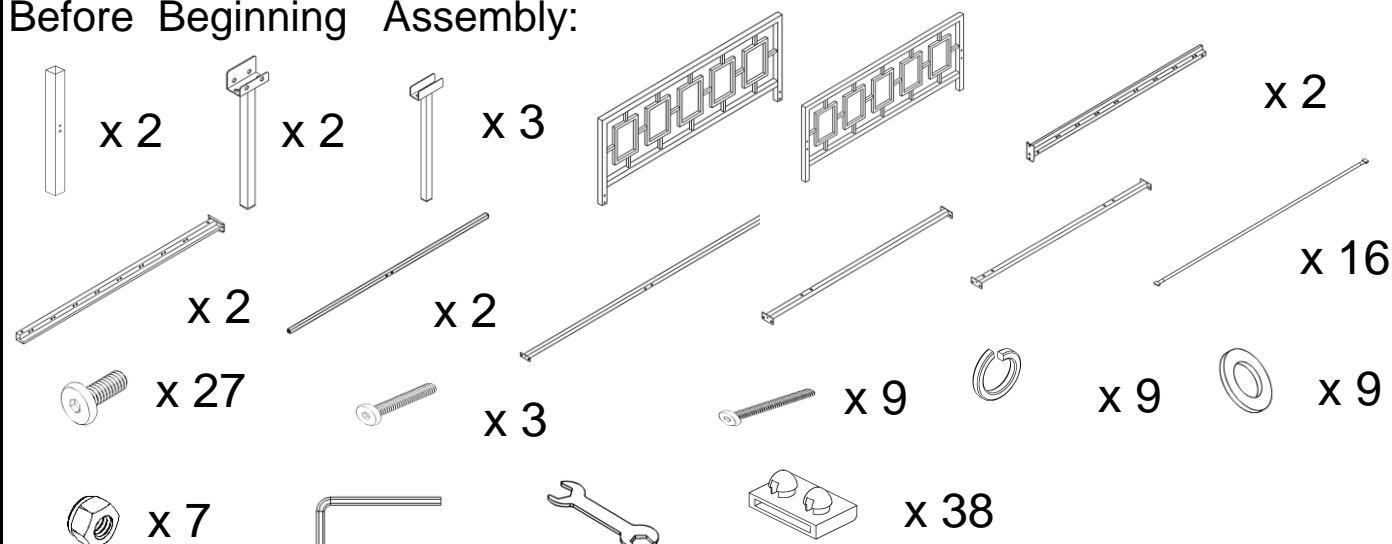



- Read instructions, cover to cover-



- Have 2 adults on hand for assembly-



- Do not assemble on flooring or carpet-



- Assemble on a clean non-marring surface (packing foam)-



- Save all packaging until finished-

## Assembly Steps

### Overview

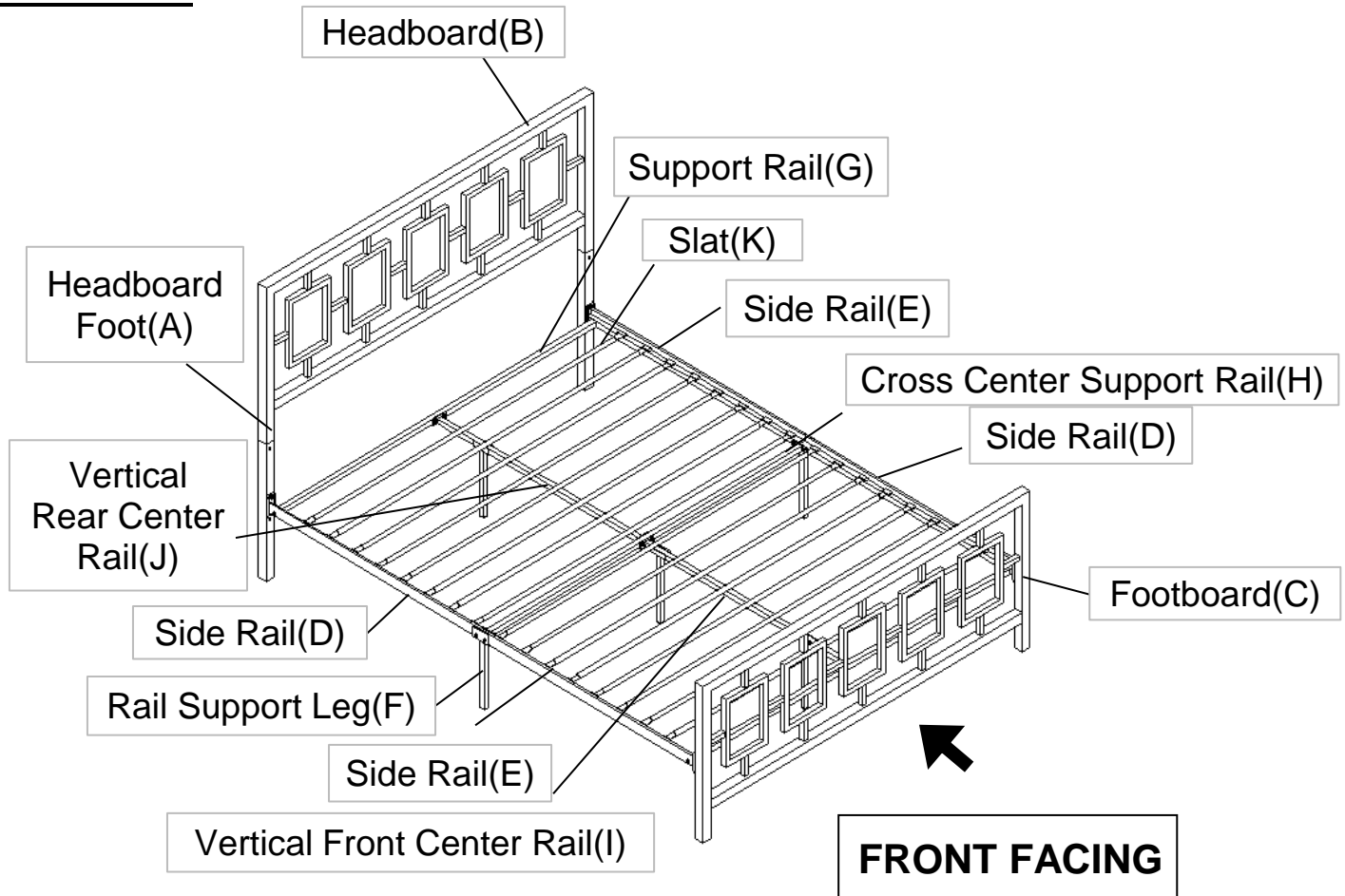

This bed has multiple parts and may require up to some 60 minutes to assemble.

To give you an overview of the bed parts, the above picture is to help you put the various parts into perspective.

Please read through the instructions below to familiarise yourself with the parts and steps before assembly.



### Step 3

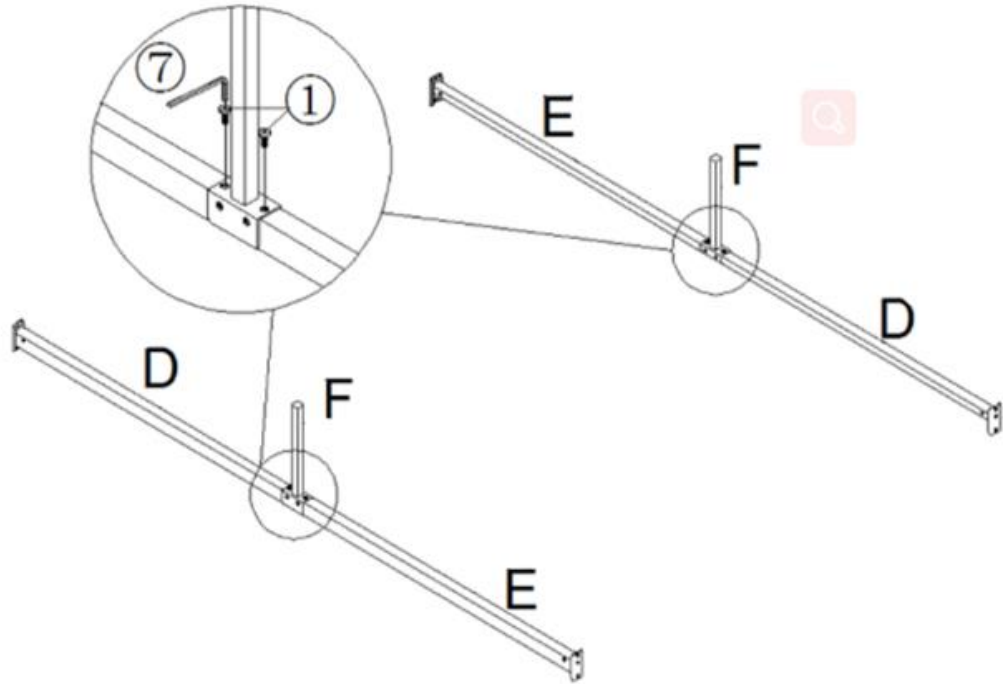

Align the mounting positions of Rail Support Leg(F) to Side Rail(D&E). Attach Rail Support Leg(F) to Side Rail(D&E) using Bolt(1) with Allen Key(7).

Repeat same step to assemble the other Side Rail(D&E).

### Step 4

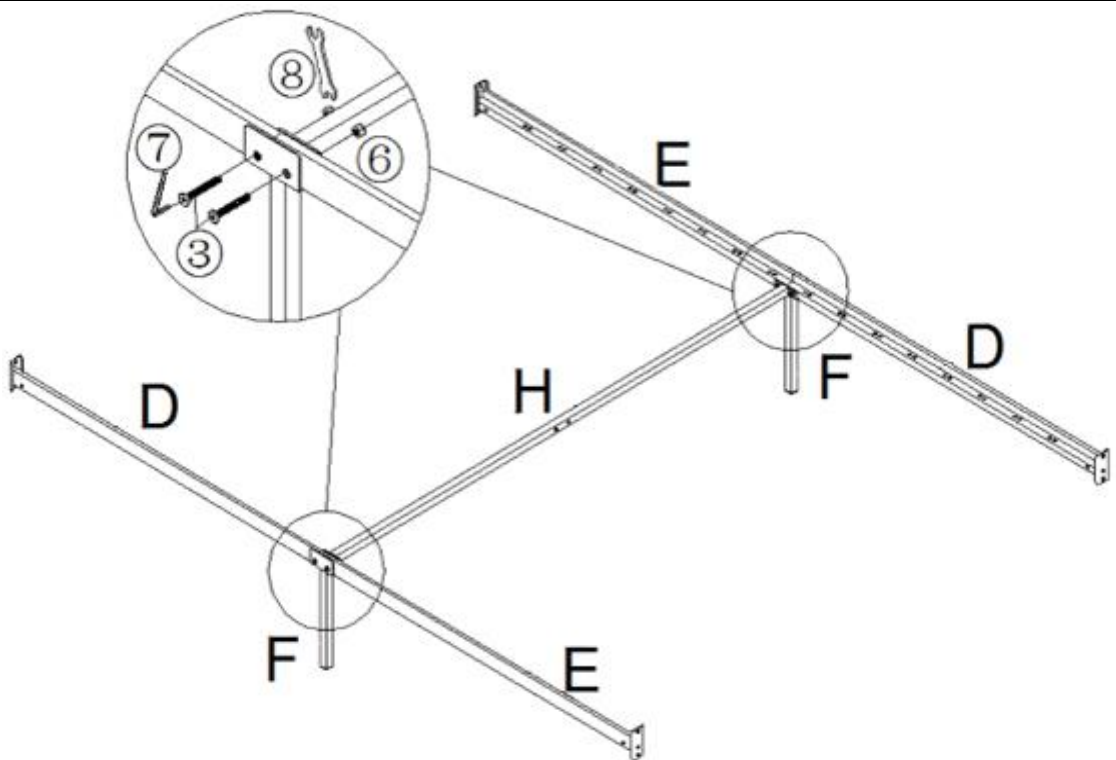

With the assistance of your adult partners, turn over the assembled rails. Attach Cross Center Support Rail(H) to the assembled Rail(E&F) using Bolt(3) and Nut(6) with Allen Key(7) and Wrench(8).

## Step 5

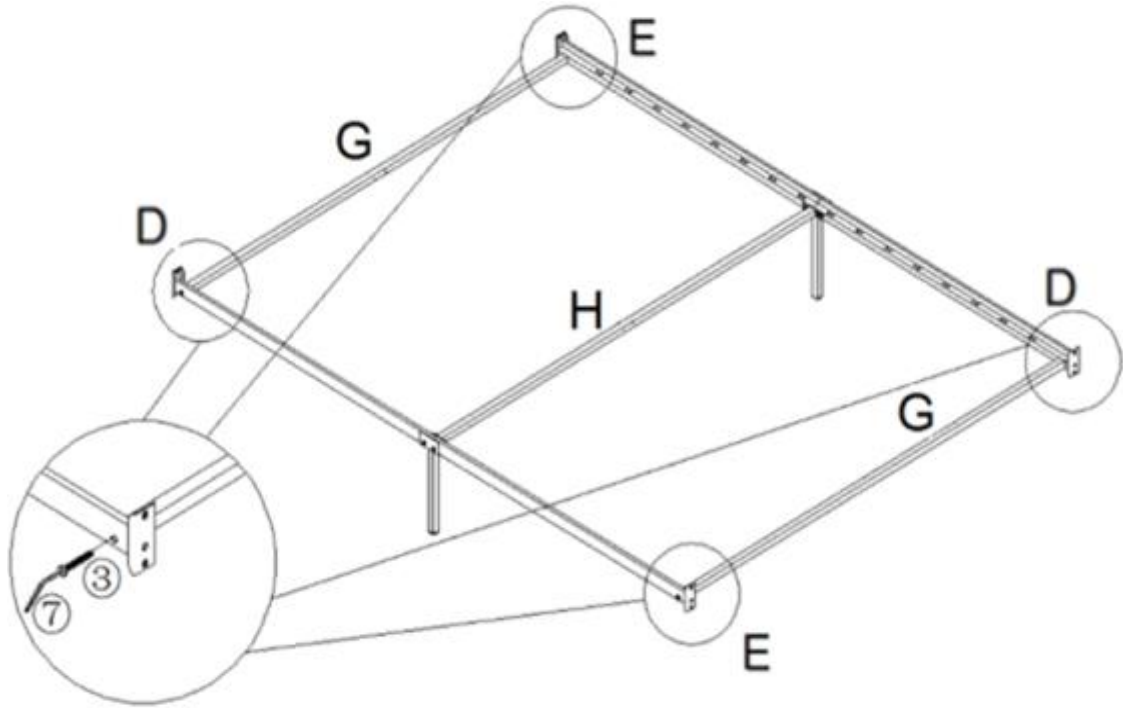

Attach Support Rail(G) to the Side Rail(D&E) using Blot(③) with Allen Key(⑦).

## Step 6

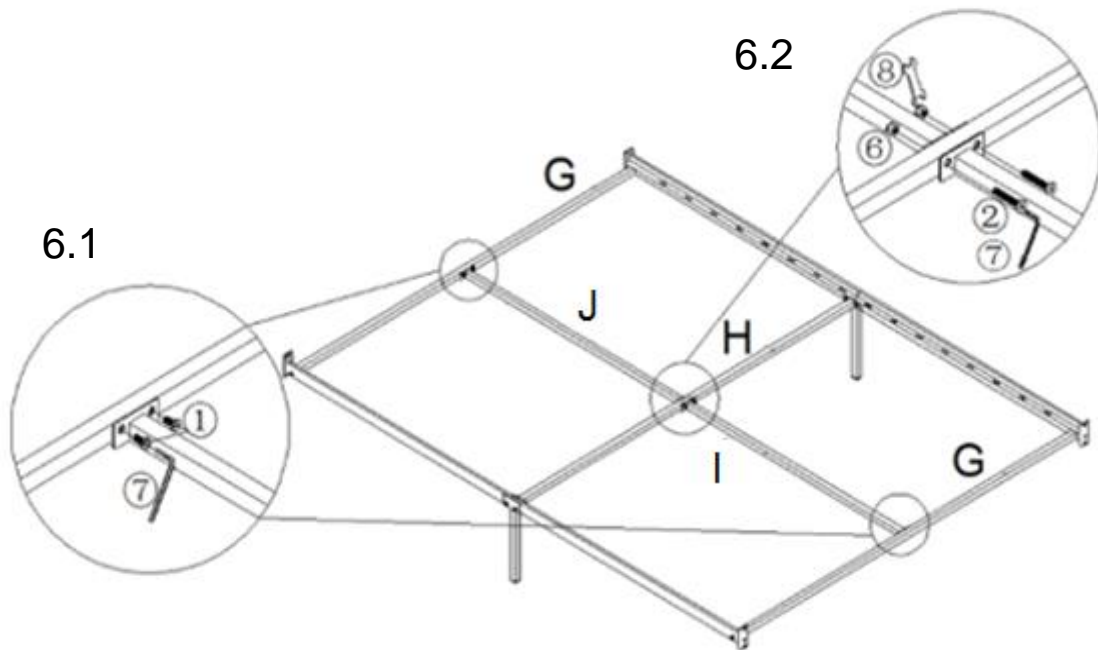

6.1: Attach Vertical Front Center Rail(I) and Vertical Rear Center Rail(J) to Support Rail(G) using Blot(①) with Allen Key(⑦).

6.2: Attach Vertical Rear Center Rail(J) and Vertical Front Center Rail(I) to Cross Center Support Rail(H) using Bolt(②) and Nut(⑥) with Allen Key(⑦) and Wrench(⑧).

## Step 7

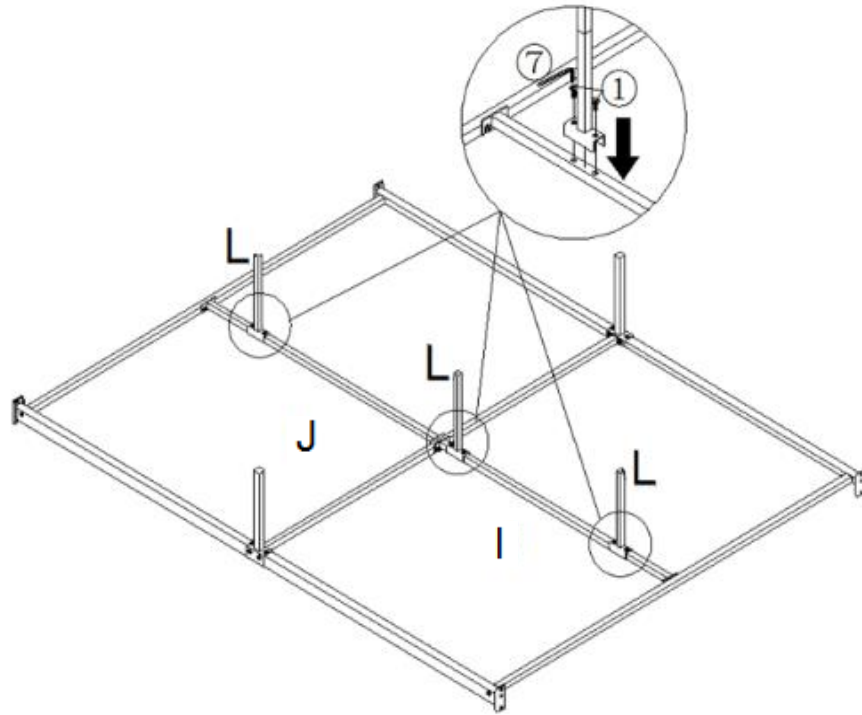

With the assistance of your adult partners, turn over the assembled frame. Attach Center Support Leg(L) to the Vertical Front Center Rail(I) and Vertical Rear Center Rail(J) using Blot(①) with Allen Key(⑦).

**Note: After assembling, turn the assembled frame rightside up.**

## Step 8

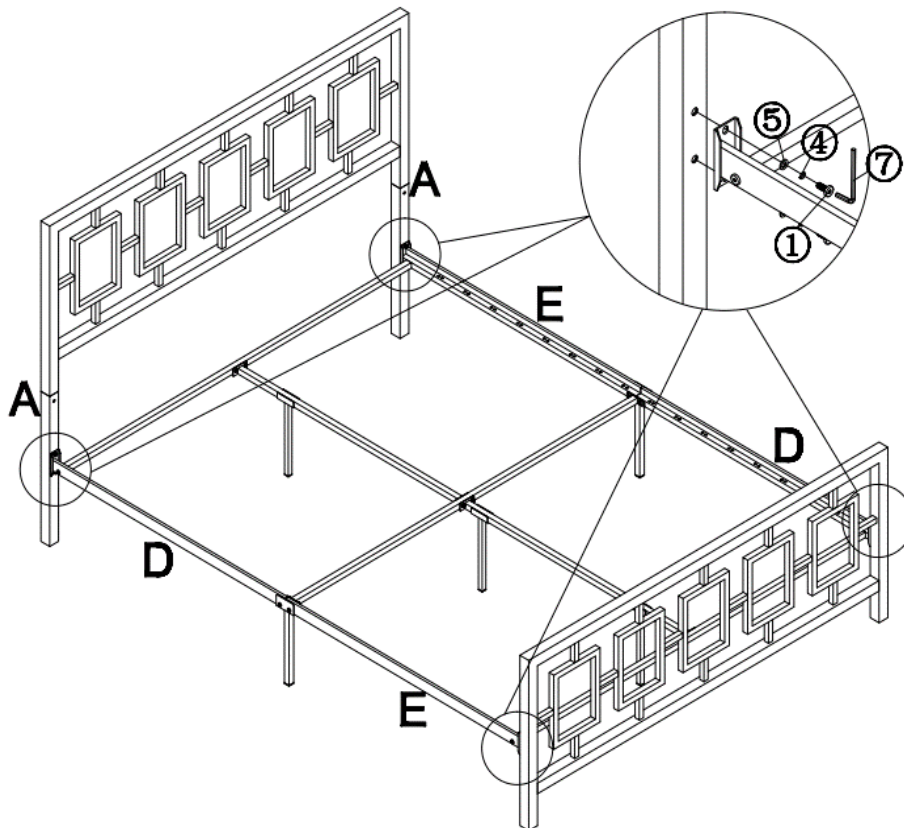

Attach metal frame to Headboard Foot(A) and Footboard(C) using Blot(①), Spring Washer(④) and Flat Washer(⑤) with Allen Key(⑦).

## Step 9

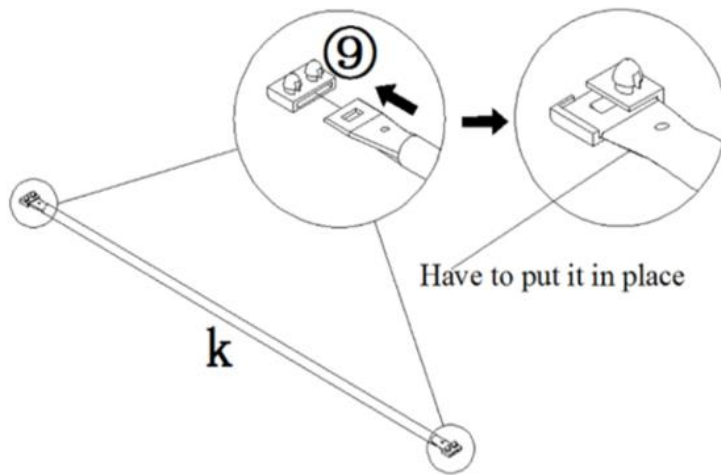

Insert Slat Connectors(⑨) into both sides of Slat(K), the connectors have to put it in place.

## Step 10

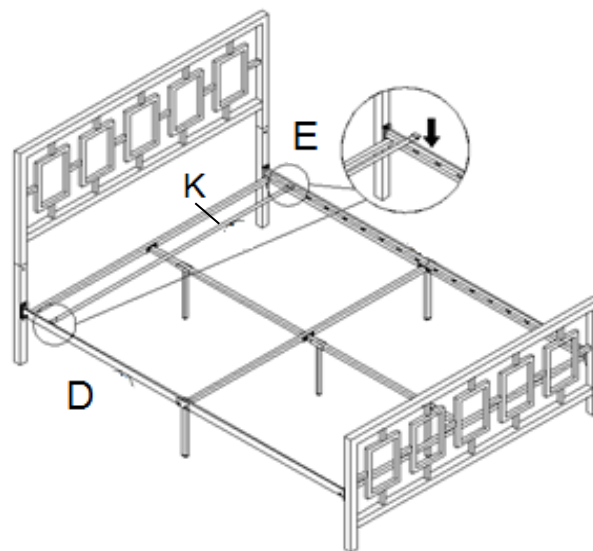

Attach assembled Slat(K) to the mounting position of Side Rails(D&E). Repeat the same step to assemble remaining Slat.



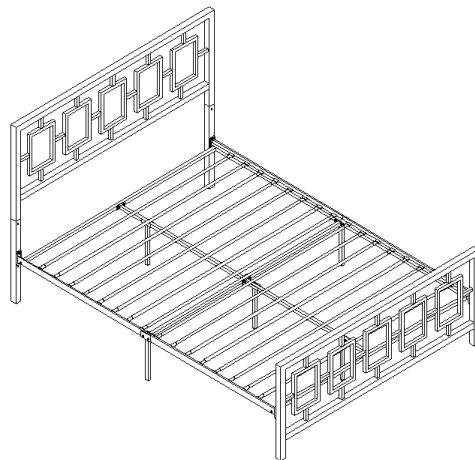

















## Step 11



Now, fully and securely, tighten all nuts, at all joints.  
Inspect it and make sure all parts are adequately connected.  
Your bed is ready for use.

**Caution: This Bed can only be used on a flat, level surface.**

## Care & Maintenance

-   ● Do not put hot items directly on furniture surface
  -   ● Do not clean furniture with harsh cleansers or polish.
  -   ● Do not place furniture under direct sunlight.
  -   ● Do not place furniture near heating or cooling vents.
  -   ● Do not write on furniture without a padded barrier to protect the surface.
  -   ● Do not place furniture outside. For indoor use only.
  -   ● Not for commercial use. For residential use only .
  -   ● Stains may be removed with mild soap solution and damp cloth.
  -   ● Children should not climb or jump on the furniture.
- 
-   ● Dust and pick-up spills using a clean, non-colored, lint-free cloth .

### Questions & Answers about Proposition 65

#### • What is Proposition 65?

Proposition 65 requires businesses to provide warnings to Californians about significant exposures to chemicals that cause cancer, birth defects or other reproductive harm. These chemicals can be in the products that Californians purchase, in their homes or workplaces, or that are released into the environment. By requiring that this information be provided, Proposition 65 enables Californians to make informed decisions about their exposures to these chemicals.

Proposition 65 also prohibits California businesses from knowingly discharging significant amounts of listed chemicals into sources of drinking water.

Proposition 65 requires California to publish a list of chemicals known to cause cancer, birth defects or other reproductive harm. This list, which must be updated at least once a year, has grown to include approximately 900 chemicals since it was first published in 1987.

#### • What types of chemicals are on the Proposition 65 list?

The list contains a wide range of naturally occurring and synthetic chemicals that include additives or ingredients in pesticides, common household products, food, drugs, dyes, or solvents. Listed chemicals may also be used in manufacturing and construction, or they may be byproducts of chemical processes, such as motor vehicle exhaust.

#### • What does a warning mean?

If a warning is placed on a product label or posted or distributed at a workplace, a business, or in rental housing, the business issuing the warning is aware or believes that it is exposing individuals to one or more listed chemicals.

By law, a warning must be given for listed chemicals unless the exposure is low enough to pose no significant risk of cancer or is significantly below levels observed to cause birth defects or other reproductive harm.

#### • Where can I get more information on Proposition 65?

If you have specific questions on the administration or implementation of Proposition 65, you can contact OEHHA's Proposition 65 program at [P65.Questions@oehha.ca.gov](mailto:P65.Questions@oehha.ca.gov), or by phone at (916) 445-6900.