

# ***Shark***

**TurboBlade™  
Cool + Heat  
Fan  
TH200 Series**

**OWNER'S GUIDE**

---



*Unit may vary in features, size, and color*

# IMPORTANT SAFETY INSTRUCTIONS

SUITABLE FOR HOUSEHOLD USE ONLY.

## ⚠️ WARNING

**TO REDUCE THE RISK OF FIRE, ELECTRIC SHOCK, OR INJURY, READ ALL THESE INSTRUCTIONS BEFORE USE.**

- Read all instructions before use.
- This appliance has a polarized plug (one blade is wider than the other). To reduce the risk of electric shock, this plug is intended to fit in a polarized outlet only one way. If the plug does not fit fully in the outlet, reverse the plug. If it still does not fit, contact a qualified electrician. **DO NOT** attempt to defeat this safety feature. Unplug or disconnect the appliance from the power supply before servicing.
- DO NOT** operate any appliance with a damaged cord or plug. Discard appliance or return to an authorized service facility for examination and/or repair.
- DO NOT** run cord under carpeting. **DO NOT** cover cord with throw rugs, runners, or similar coverings. **DO NOT** route cord under furniture or appliances. Keep cord away from high traffic areas and place cord where it will not be tripped over.
- If the power cord is damaged, it must be replaced by the manufacturer, its service agent, or similarly qualified persons in order to avoid a hazard.
- This appliance is not intended for use by anyone (including children) with reduced physical, sensory or mental capabilities, or lack of experience and knowledge, unless they have been given supervision or instruction concerning use of the appliance by a person responsible for their safety.
- Children should be supervised to ensure that they **DO NOT** play with the appliance.
- Cleaning and user maintenance shall not be made by children without supervision.
- Prior to cleaning or other maintenance, the appliance must be unplugged from the electrical outlet.
- DO NOT** handle plug or appliance with wet hands.
- DO NOT** use without filter in place.
- Only use Shark® branded filters and accessories.
- DO NOT** damage the power cord:
  - DO NOT** pull or carry appliance by the cord or use the cord as a handle.
  - DO NOT** unplug by pulling on cord. Grasp the plug, not the cord.
  - DO NOT** stand the appliance on the power cord, close a door on the cord, pull the cord around sharp corners, or leave the cord near heated surfaces.
- DO NOT** use with any opening blocked; keep free of dust, lint, hair, and anything that may reduce airflow.
- DO NOT** use if airflow is restricted. If the air paths become blocked, turn the appliance off and unplug from electrical outlet. Remove all obstructions before you plug in and turn on the unit again.
- DO NOT** use if appliance is not working as it should, or has been dropped, damaged, left outdoors, or dropped into water.
- DO NOT** place appliance on unstable surfaces such as chairs or other furniture.
- DO NOT** use in the following areas:
  - Wet or damp surfaces
  - Outdoor areas
  - Spaces that are enclosed and may contain explosive or toxic fumes or vapors (lighter fluid, gasoline, kerosene, paint, paint thinners, mothproofing substances, or flammable dust)
- Turn off all controls before unplugging the appliance.
- Unplug from electrical outlet when not in use and before any maintenance or cleaning.
- Hand wash with soapy water only. Washing with cleaning chemicals could damage the unit.
- Make sure filter is in place after routine maintenance.
- Not suitable for use with solid-state speed controls.

### ⚠️ BATTERY REMOVAL AND DISPOSAL

This remote control uses an AAA battery. When the remote battery no longer has a charge, it should be removed from the remote and recycled. **DO NOT** incinerate or compost the product with its integral battery or the remote battery. When your remote battery needs to be replaced, dispose of it or recycle it in accordance with local ordinances or regulations. In some areas, it is illegal to place spent batteries in the trash or in a municipal solid waste stream. Return spent battery to an authorized recycling center or to retailer for recycling. Contact your local recycling center for information on where to drop off the spent battery.

### ⚠️ IMPORTANT INSTRUCTIONS

- This heater is hot when in use. To avoid burns, **DO NOT** let bare skin touch hot surfaces. If provided, use handles when moving this heater. Keep combustible materials, such as furniture, pillows, bedding, papers, clothes, and curtains at least 3 feet (0.9 m) from the front of the heater and keep them away from the sides and rear.

- Extreme caution is necessary when any heater is used by or near children or a disabled person and whenever the heater is left operating and unattended.
- Always unplug heater when not in use.
- This heater is not intended for use in bathrooms, laundry areas, or similar indoor locations. Never locate heater where it may fall into a bathtub or other water container.
- DO NOT** insert or allow foreign objects to enter any ventilation or exhaust opening, as this may cause an electric shock or fire, or damage the heater.
- To prevent a possible fire, **DO NOT** block air intakes or exhaust in any manner. **DO NOT** use on soft surfaces, like a bed, where openings may become blocked.
- A heater has hot and arcing or sparking parts inside. **DO NOT** use it in areas where gasoline, paint, or flammable liquids are used or stored.
- Use this heater only as described in this manual. Any other use not recommended by the manufacturer may cause fire, electric shock, or injury to persons.
- Always plug heaters directly into a wall outlet/receptacle. Never use with an extension cord or relocatable power tap (outlet/power strip).
- Hyperthermia can result in death. Symptoms of hyperthermia include high body temperature, headache, nausea, vomiting, tiredness, dizziness, fainting, and rapid pulse. If you begin to experience symptoms related to hyperthermia, turn off the heater and seek medical attention.

To avoid excessive room temperatures which can cause hyperthermia, **DO NOT** leave product running unattended in a confined space around infants, or individuals with reduced physical, sensory, or mental capabilities.

**⚠️ CAUTION** – High temperature. Keep electrical cords, drapery, and other furnishings at least 3 feet (0.9 m) from the front of the heater and away from the sides and rear.

**⚠️ WARNING** – Risk of hyperthermia.

**⚠️ CAUTION: Risk of fire - DO NOT** operate without base attached.

### ⚠️ POWER SUPPLY SAFETY

- Read and follow all instructions that are on the product or provided with the product.
- DO NOT** use an extension cord.
- DO NOT** use within 10 feet of a pool and **DO NOT** use in a bathroom.

### ⚠️ FCC WARNINGS

**Note:** This equipment has been tested and complies with the limits for a Class B digital device, pursuant to part 15 of the FCC Rules.

These limits are designed to provide reasonable protection against harmful interference in a residential installation. This equipment generates, uses, and can radiate radio frequency energy, and if not installed and used in accordance with the instructions, may cause harmful interference to radio communications.

To see if this equipment interferes with radio or television reception, try turning the equipment off and on. To correct any interference:

- Reorient or relocate the receiving antenna.
- Increase the distance between the equipment and the receiver.
- Connect the equipment to a different outlet than the receiver.
- Consult the dealer or an experienced technician for help.

This equipment complies with FCC radiation exposure limits set forth for an uncontrolled environment. This equipment should be installed and operated with a minimum distance of 20 cm between the radiator and any part of your body.

This equipment complies with ISED RSS-102 radiation exposure limits set forth for an uncontrolled environment. This equipment should be installed and operated with a minimum distance of 20 cm between the radiator and any part of your body.

This device complies with Part 15 of the FCC Rules. Operation is subject to two conditions:

- This device may not cause harmful interference, and
- this device must accept any interference received, including interference that may cause undesired operation.

**Caution:** Any changes or modifications to this unit not expressly approved by the party responsible for compliance could void the user's authority to operate the equipment

### IC statement:

This device contains licence-exempt transmitter(s)/receiver(s) that comply with Innovation, Science and Economic Development Canada's licence-exempt RSS(s). Operation is subject to the following two conditions:

- This device may not cause interference.
- This device must accept any interference, including interference that may cause undesired operation of the device.

**⚠️ WARNING: DO NOT COVER**

**⚠️ WARNING: HOT SURFACE**

## INCLUDES

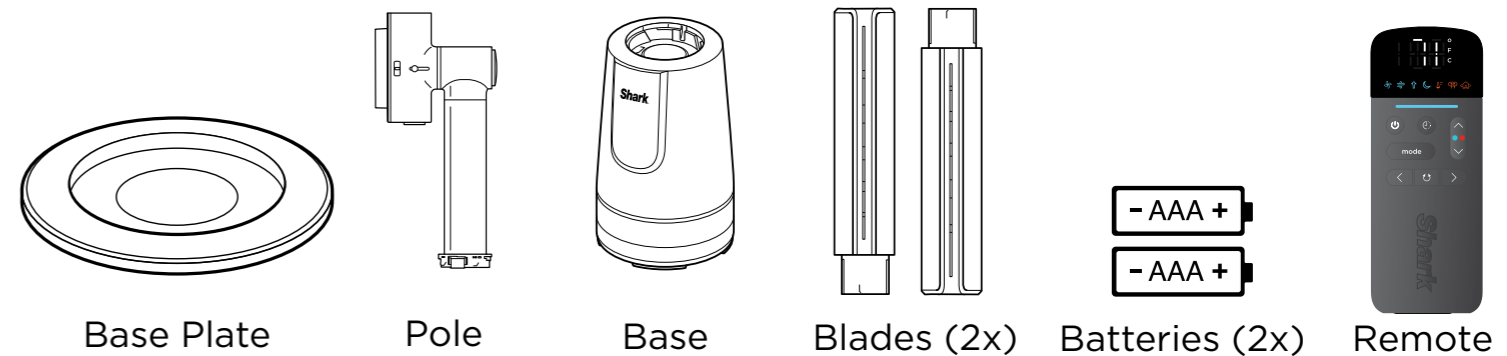

Base Plate

Pole

Base

Blades (2x)

Batteries (2x)

Remote

## ASSEMBLY

1

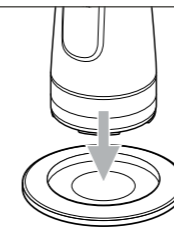

Use the red guide markings to align the **Base** onto the **Base Plate**.

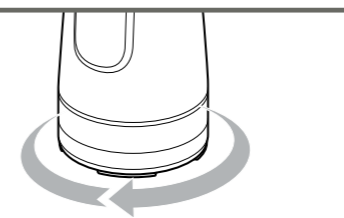

Rotate the base clockwise until it clicks into place.

2

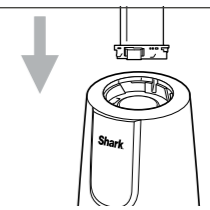

Align the guide mark printed on the **Pole** with the guide mark printed on the **Base**, then insert the **Pole**.

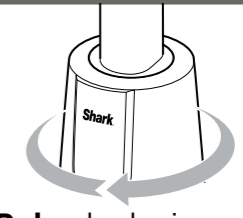

Twist the **Pole** clockwise until it clicks, locking into place. Heater will not engage unless arrow and filled-in circle are aligned. Remove tape.

3

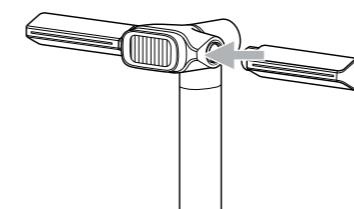

Remove assembly tape and cardboard from the **Pole**. Line up the printed red circle on the **Blade** with the red circle on the inner **Pole**.

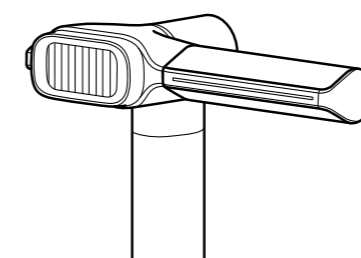

Press the **Blade** firmly into the **Pole** until it clicks into place. Repeat on other side.

4

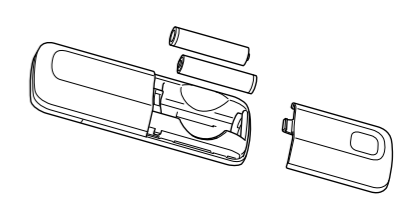

Install the **2 AAA batteries** in the remote. Make sure the batteries are installed with the correct polarity (+ and -).

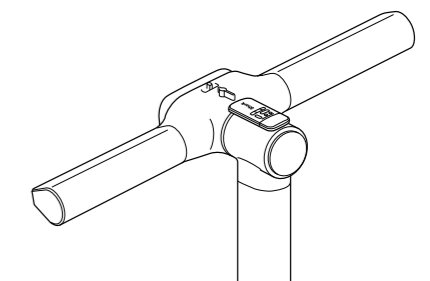

Store the remote on the magnetic mount on the back of the **Pole**.

**READ AND SAVE THESE INSTRUCTIONS**

Please be sure to read and save the warnings prior to using your unit.

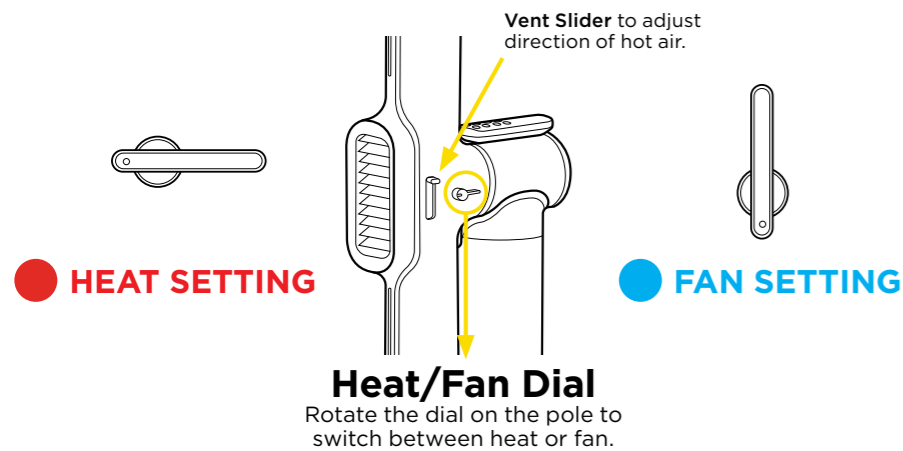

visit [qr.sharkclean.com/TH200series](http://qr.sharkclean.com/TH200series) or

**SCAN HERE**



USING YOUR SMARTPHONE CAMERA TO PURCHASE REPLACEMENT PARTS.

### ON-UNIT DISPLAY

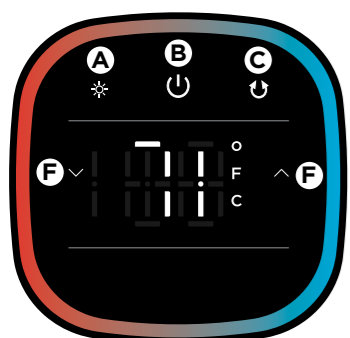

- A** **BRIGHTNESS**  
Press to adjust the brightness of the display panel. Choose between 4 levels of brightness.
- B** **POWER**  
Press to power unit on or off. It may take a moment for the unit to cool down after the heat has been turned off.
- C** **OSCILLATION**  
Press to cycle through oscillation range options. Setting 1 is 45 degrees, setting 2 is 90 degrees, and setting 3 is 180 degrees.
- F** **FAN/THERMO IQ ARROWS**  
When in Fan mode, press the arrows to adjust fan speed up or down. When in Heat mode, press the arrows to adjust the thermostat temperature.

### REMOTE

#### FAN FUNCTIONS



- F** **SPEED ADJUST**  
Press up and down arrows to scroll between fan speeds 1-10.
- G** **FAN MODES**  
Press to cycle between Sleep, BreezeBoost™, and Natural Breeze settings.  
*Note: some models have High and Low versions.*
  - Sleep mode:** Mute chimes, dim lights, and switch to an ideal fan speed for sleep.
  - BreezeBoost™:** For a powerful burst of airflow.
  - Natural Breeze:** Varying airflow patterns to simulate natural wind.

#### HEAT FUNCTIONS

- F** **THERMO IQ MODE™**  
Press up and down arrows to set desired temperature. The heater will automatically adjust based on your selection.
- G** **HEAT MODES (remote only)**  
Press the mode button to cycle between Comfort and Focus settings.  
*Note: some models have High and Low versions.*
  - Comfort:** Soothing warmth for sustained use.
  - Focus:** Powerful, directed heating.

#### SHARED FUNCTIONS

- C** **OSCILLATION**  
Press the oscillation button to cycle through oscillation range options. Setting 1 is 45 degrees, setting 2 is 90 degrees, and setting 3 is 180 degrees.
- D** **TIMER**  
Press the timer button to cycle through timer settings. Automatically turns off power after 1, 2, 4, or 8 hours.
- C** + **D** **MUTE CHIME**  
Press and hold oscillation and timer buttons for 5 seconds to mute chimes. Repeat to re-enable.
- E** **ANGLE ADJUST**  
Press the left and right arrows to slightly adjust the direction of fan.

### PRODUCT TIPS

**PIVOT AND TILT:** Manually adjust the fan blade's orientation (1) and tilt (2) to personalize your airflow.  
**NOTE:** The blade only rotates counterclockwise up to 90 degrees.

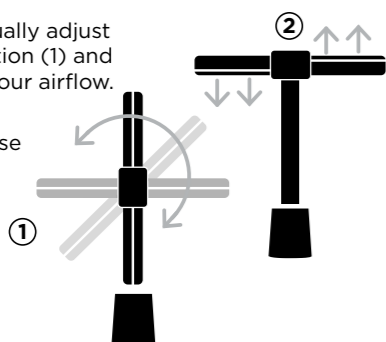

**DUST DEFENSE™** panel on the rear of the unit collects dust to make cleaning easier. Clean every 6 months or as needed.

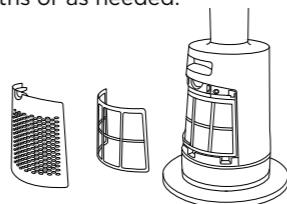

**CARRYING POSITION:** Carry the unit by the handle on the base while supporting the air duct.

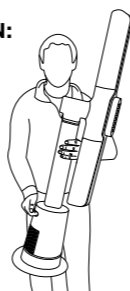

### MAINTENANCE

- Unplug the fan before doing any cleaning or maintenance.
- We recommend cleaning the fan every 6 months, or as needed.
- We recommend changing the batteries in the remote control every 12 months, or as needed.

### DUST DEFENSE™

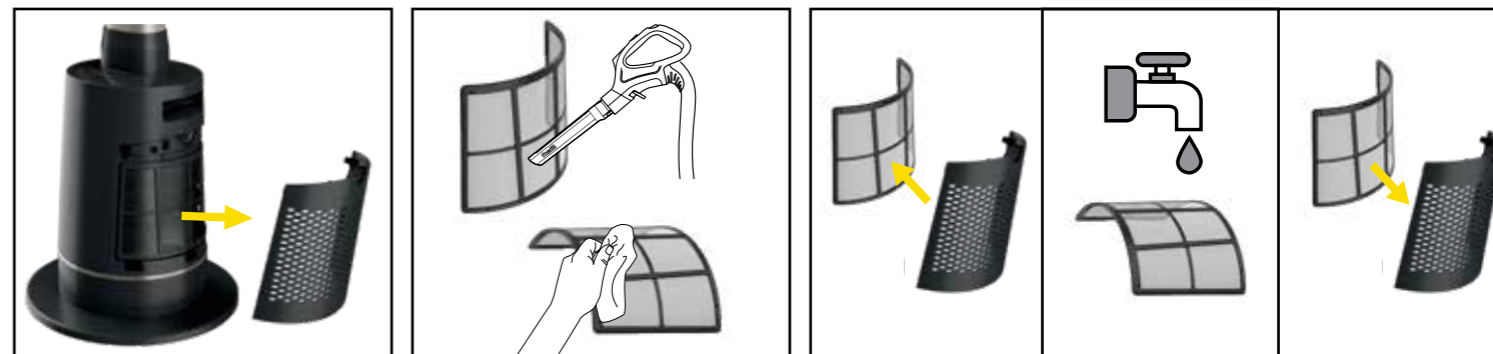

1. Remove the Dust Defense panel from the unit by gently pulling on the finger tab.  
*Note: the mesh filter does not need to be removed from the Dust Defense panel.*
2. Use a vacuum cleaner on low speed with a soft brush attachment OR wipe with a cloth or towel to remove debris from the Dust Defense panel and the internal mesh filter. **DO NOT use abrasive chemical cleaners.**
3. **OPTIONAL:** If debris is stuck between the mesh filter and the Dust Defense panel, the filter can be removed by gently pulling it out of the tabs on the panel. Rinse the filter and the panel with room-temperature tap water. Allow both the filter and the panel to air-dry for 12 hours before reinstalling. **DO NOT** use the fan when the mesh filter is wet.

### DUST DEFENSE (CONTINUED)



4. Replace the Dust Defense panel by inserting the tabs on the bottom of the panel into the indents on the unit and pushing the panel in until it clicks into place.

### EXTERNAL CLEANING

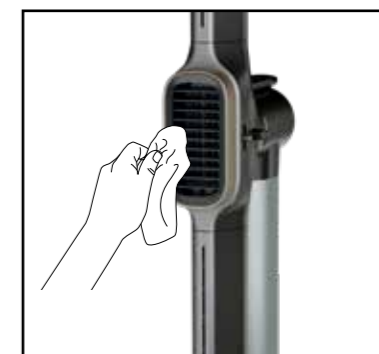

To clean the exterior of the fan, wipe it down with a microfiber cloth dampened with warm, soapy water. To prevent damage, do not use abrasive chemical cleaners or too much water.

### REPLACING THE BATTERIES IN THE REMOTE

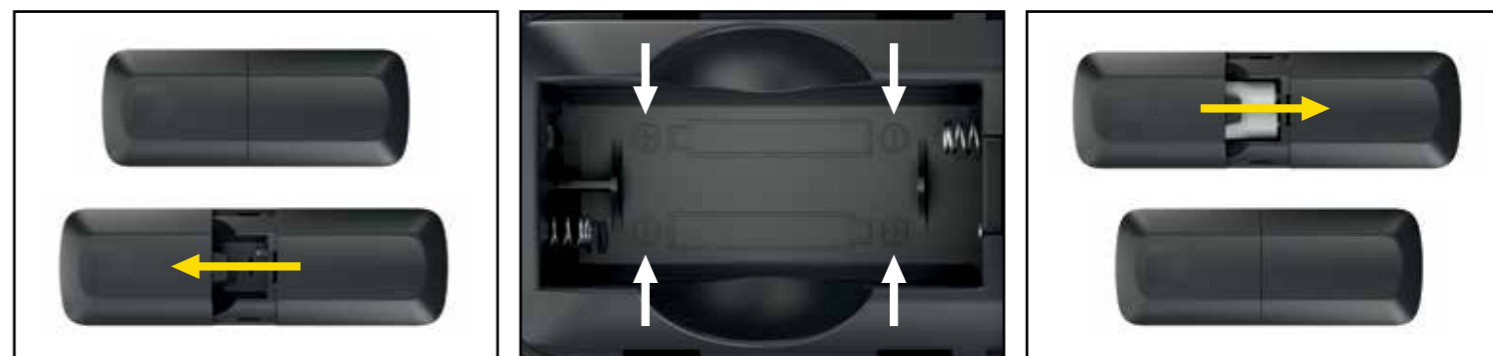

1. To access the batteries, push down gently on the battery door on the back of the remote, then slide the door off. Remove the batteries from the chamber and follow local ordinances for battery disposal.
2. Insert 2 new AAA batteries into the remote. Make sure the batteries are installed in correct orientation as shown in the battery chamber.
3. Slide the battery door back into place on the back of the remote.

## TROUBLESHOOTING AND FREQUENTLY ASKED QUESTIONS

# Shark NINJA

### TWO (2) YEAR LIMITED WARRANTY

The Two (2) Year Limited Warranty applies to purchases made from authorized retailers of **SharkNinja Operating LLC**. Warranty coverage applies to the original owner and to the original product only and is not transferable.

SharkNinja warrants that the unit shall be free from defects in material and workmanship for a period of two (2) years from the date of purchase when it is used under normal household conditions and maintained according to the requirements outlined in the Owner's Guide, subject to the following conditions and exclusions:

#### What is covered by this warranty?

- The original unit and/or non-wearable parts deemed defective, in SharkNinja's sole discretion, will be repaired or replaced up to two (2) years from the original purchase date.
- In the event a replacement unit is issued, the warranty coverage ends six (6) months following the receipt date of the replacement unit or the remainder of the existing warranty, whichever is later. SharkNinja reserves the right to replace the unit with one of equal or greater value.

#### What is not covered by this warranty?

- Normal wear and tear of wearable parts (such as batteries, etc.), which require regular maintenance and/or replacement to ensure the proper functioning of your unit, are not covered by this warranty. Replacement parts are available for purchase at [sharkaccessories.com](http://sharkaccessories.com).
- Any unit that has been tampered with or used for commercial purposes.
- Damage caused by misuse, abuse, negligent handling, failure to perform required maintenance (e.g., not replacing the filters), or damage due to mishandling in transit.
- Consequential and incidental damages.

- Defects caused by repair persons not authorized by SharkNinja. These defects include damages caused in the process of shipping, altering, or repairing the SharkNinja product (or any of its parts) when the repair is performed by a repair person not authorized by SharkNinja.
- Products purchased, used, or operated outside North America.

#### How to get service

If your appliance fails to operate properly while in use under normal household conditions within the warranty period, visit [sharkclean.com/support](http://sharkclean.com/support) for product care and maintenance self-help. Our Customer Service Specialists are also available at **1-855-523-4061** to assist with product support and warranty service options, including the possibility of upgrading to our VIP warranty service options for select product categories. So we may better assist you, please register your product online at [registryyourshark.com](http://registryyourshark.com) and have the product on hand when you call.

SharkNinja will cover the cost for the customer to send in the unit to us for repair or replacement. A fee of \$25.95 (subject to change) will be charged when SharkNinja ships the repaired or replacement unit.

#### How to initiate a warranty claim

You must call **1-855-523-4061** to initiate a warranty claim. You will need the receipt as proof of purchase. We also ask that you register your product online at [registryyourshark.com](http://registryyourshark.com) and have the product on hand when you call, so we may better assist you. A Customer Service Specialist will provide you with return and packing instruction information.

#### How state law applies

This warranty gives you specific legal rights, and you also may have other rights that vary from state to state. Some states do not permit the exclusion or limitation of incidental or consequential damages, so the above may not apply to you.

### IMPORTANT INFORMATION

#### REGISTER YOUR PURCHASE

 [registryyourshark.com](http://registryyourshark.com)

 Scan QR code using mobile device



#### BATTERY REMOVAL AND DISPOSAL

This remote control uses 2 AAA batteries. When the remote batteries no longer have a charge, they should be removed from the remote and recycled. DO NOT incinerate or compost the product with its integral battery or the remote batteries. When your remote batteries need to be replaced, dispose of them or recycle them in accordance with local ordinances or regulations. In some areas, it is illegal to place spent batteries in the trash or in a municipal solid waste stream. Return spent batteries to an authorized recycling center or to retailer for recycling. Contact your local recycling center for information on where to drop off the spent batteries.



#### FCC WARNINGS

Note: This unit has been tested and found to comply with FCC limits for Class B digital devices. These limits are designed to provide reasonable protection against harmful interference in a residential installation. This unit generates, uses, and can radiate radio frequency energy, and if not installed and used in accordance with the instructions, may cause harmful interference to radio communications.

This device complies with part 15 of the FCC Rules. Operation is subject to the following two conditions: (1) this device may not cause harmful interference, and (2) this device must accept any interference received, including interference that may cause undesired operation.

To see if this unit interferes with radio or television reception, try turning it off and on.

To correct any interference:

- Reorient or relocate the receiving antenna.
- Increase the distance between the unit and the receiver.
- Connect the unit to a different outlet than the receiver.
- Consult the dealer or an experienced technician for help.

Caution: Any changes or modifications to this unit not expressly approved by the party responsible for compliance could void the user's authority to operate it.

#### RECORD THIS INFORMATION

Model Number: \_\_\_\_\_

Serial Number: \_\_\_\_\_

Date of Purchase: \_\_\_\_\_  
(Keep receipt)

Store of Purchase: \_\_\_\_\_

#### TECHNICAL SPECIFICATIONS

Voltage: 120V~ 60Hz / 1.6A  
Watts: 1500W

Benefits of registering your product and creating an account:

- Get easier, faster product support and access to warranty information
- Access troubleshooting and product care instructions
- Be among the first to know about exclusive product promotions

**TIP:** You can find the model and serial numbers on the QR code label on the underside of the fan head.

#### PLEASE READ CAREFULLY AND KEEP FOR FUTURE REFERENCE.

This Owner's Guide is designed to help you get a complete understanding of your new Shark® fan.

SharkNinja Operating LLC  
US: Needham, MA 02494  
CAN: Ville St-Laurent, QC H4S 1A7  
1-800-798-7398  
[sharkclean.com](http://sharkclean.com)

Illustrations may differ from actual product. We are constantly striving to improve our products; therefore the specifications contained herein are subject to change without notice.

This product may be covered by one or more U.S. patents. See [sharkninja.com/patents](http://sharkninja.com/patents) for more information.

### GENERAL USE

<b>How do I take my fan apart?</b>	We do not recommend taking your unit apart as it is only safe to operate when fully assembled. However, it is possible to disassemble if you need to ship it back to us. You will need a screwdriver. 1. Remove the fan blade. Make sure the blade is pointing forward, then give a strong pull on the blade and it should come out. It is normal for this to require a fair amount of force. 2. Next, remove the pole from the base. (You will need the screwdriver.) Rotate the unit all the way to the left, then slot the screwdriver into the opening behind the pole to unclip it. Rotate the pole counterclockwise to remove it. 3. To remove the base from the plate, insert the screwdriver into the opening on the bottom of the base plate to unclip it. Next, rotate the base counterclockwise to remove it from the plate.
<b>How do I switch from fan mode to heat mode?</b>	Rotate the Heat/Fan Dial on the pole to switch between fan mode and heat mode. Turn the dial to the horizontal position for heat mode, or vertical for fan mode. The lights on the on-unit display and the remote control will change to red when the unit is in heat mode, or blue when it is in fan mode.
<b>Why are the fan blades not moving or tilting?</b>	Make sure that the blade has been firmly installed into the unit. While keeping the other side of the fan stable, push the blade against the pole until there is no gap between them. When the blade is installed correctly, it will click securely into place.
<b>Why is the fan unsteady?</b>	Make sure the fan has been assembled correctly and that all parts have been completely clicked into place. Check the connection points where the base meets the base plate, and where the pole connects to the base. If the fan is still unsteady, disconnect the parts, then reassemble them, making sure they all click securely into place. For information on disconnecting the parts, see "How do I take my fan apart?" above.
<b>Why has the airflow become less powerful over time?</b>	The Dust Defense panel and mesh filter may need cleaning. Excessive dust and debris in the filter could cause a reduction in airflow power. For cleaning instructions, see "How do I clean my fan?" below.
<b>Where do I put the remote?</b>	You can store the remote on the magnetic mount on top of the pole where the sticker has an outline of the remote.

### MODES AND FUNCTIONS

<b>Why is my fan changing speeds on its own?</b>	The fan may be in Natural Breeze mode, which changes automatically to simulate natural wind. To a different fan mode, press the mode button on the remote.
<b>Why are the lights on the remote or the on-unit display not illuminated?</b>	The lights on your screen and remote will turn off after 20 seconds. To wake them up, you can press any button on the remote or screen.
<b>Why is my heater changing speeds on its own?</b>	The heater may be in Thermo IQ Mode,™ which adjusts heater output based on the current room temperature. Thermo IQ will operate by producing heat until it reaches the temperature that you set on the unit. To change the set temperature, use the arrows on the remote or on-unit display.
<b>Why are the lights dim?</b>	The fan may be in Sleep Mode, which dims the lights. To change to a different mode, press the mode button on the remote. The dimness can also be adjusted by pressing the Brightness button on the on-unit display.
<b>Why did my unit turn off on its own?</b>	In Thermo IQ Mode, the unit will turn off once the room has reached your target temperature. Additionally, as a safety measure, the unit will turn off if the room temperature ever reaches 100 degrees Fahrenheit, or after 8 hours of inactivity when on heat mode. In other instances, the unit will turn off if Timer mode was activated. The timer will turn the unit off after 1 to 8 hours. To turn off the timer, press the Timer button on the remote until it reads "0" on the remote screen.
<b>Why does my fan not beep or chime when I press buttons?</b>	Your fan may be in Mute Chime mode. Hold down the timer and oscillation buttons on the remote for 3 seconds to disable the feature.
<b>Why is the heat output low?</b>	The unit may not be in the optimal heat setting. There are three different heat modes, each optimized for different scenarios. When the Heat/Fan Dial is set to heat, press the mode button to cycle through all 3 modes. The lowest heat level is Comfort mode, intended to be used at close range for long periods of time. Use Focus mode to warm a personal space from further away. In Thermo IQ mode, you can set the temperature, and the unit will generate the ideal amount of heat to achieve and sustain that temperature.
<b>How do I disable beeping or chiming?</b>	Hold down the timer and oscillation buttons on the remote at the same time for 3 seconds to mute chiming. Repeat to turn chiming back on.

### MAINTENANCE

<b>How often should I clean the fan and the Dust Defense filter?</b>	We recommend cleaning the fan every 6 months or as needed. For cleaning instructions, see "How do I clean my fan?" below.
<b>How do I clean my fan?</b>	To clean the exterior of the fan, wipe it down with a microfiber cloth dampened with warm, soapy water. To prevent damage, do not use abrasive chemical cleaners or excess water. To clean the Dust Defense panel, remove it from the unit by gently pulling on the finger tab. (Note: The mesh filter does not need to be removed from the Dust Defense panel.) Use a vacuum cleaner on low speed with a soft brush attachment to clean the panel, or wipe the panel and mesh filter with a cloth or towel to remove debris. Do NOT use abrasive chemical cleaners. Optional: If debris is stuck in between the mesh filter and the Dust Defense panel, remove the filter by gently pulling it out of the tabs on the panel. Rinse the filter and the panel with room-temperature tap water. Allow all parts to completely air-dry for up to 12 hours before reinstalling. Do NOT use the fan when the mesh filter is wet. Reinsert the mesh filter, then reinstall the Dust Defense panel by inserting the tabs on the bottom of the panel into the indents on the unit, then push the panel in until it clicks into place.