

READ AND SAVE THIS INSTRUCTION FOR FUTURE USE

# ASSEMBLY INSTRUCTION

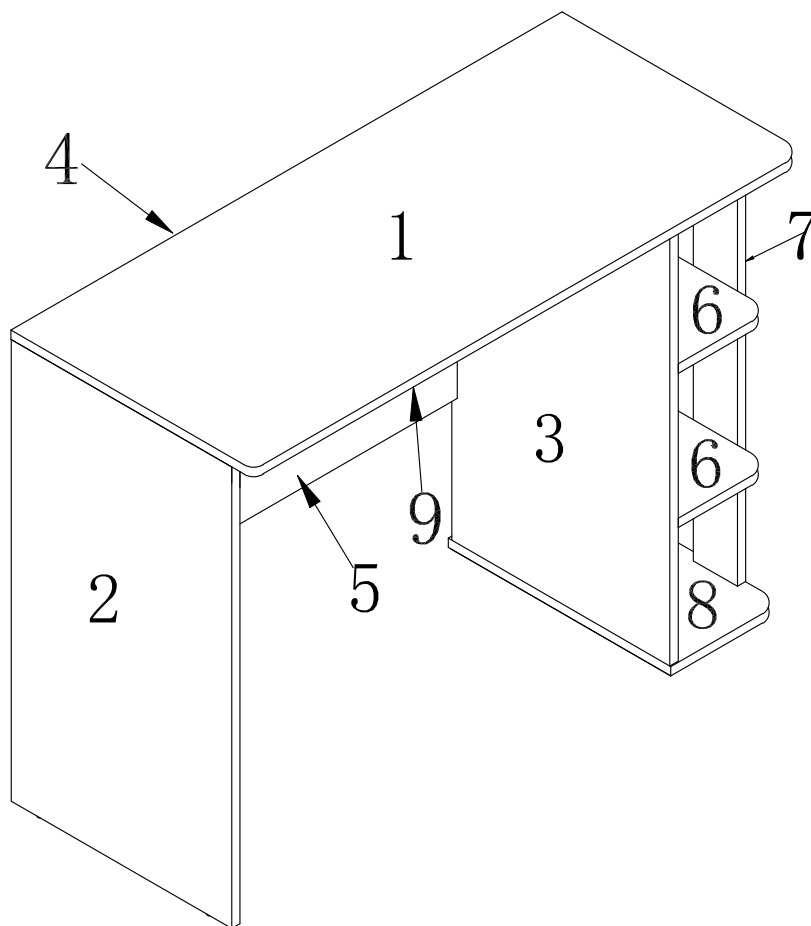

**①** x 1

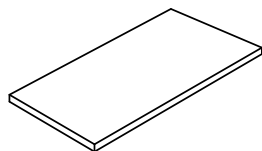

**②** x 1

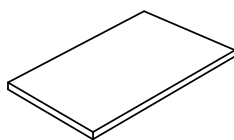

**③** x 1

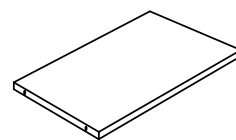

**④** x 1

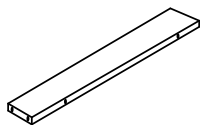

**⑤** x 1

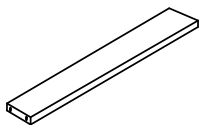

**⑥** x 2

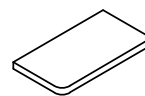

**⑦** x 2

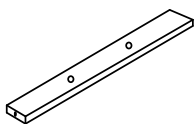

**⑧** x 1

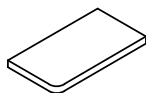

**⑨** x 1

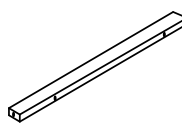

**A** x 22

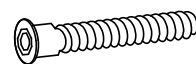

**B** x 8

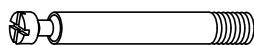

**C** x 8



**D** x 2

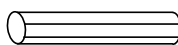

**E** x 1

