

MODEL: IG1060094C-1012

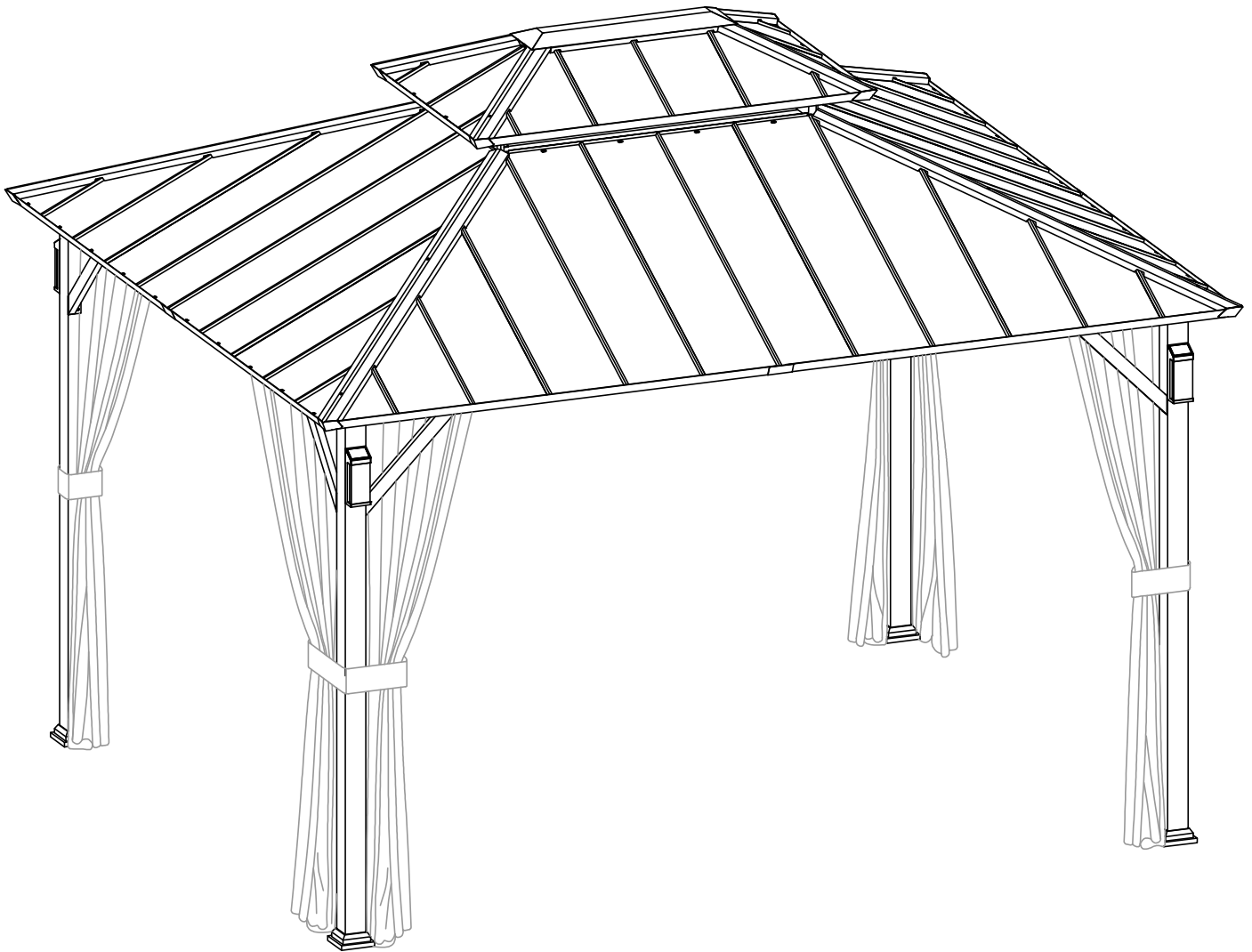

OWNER'S MANUAL

The Horizon 10'x12' Hard Top Gazebo W/ Solar LED light

TABLE OF CONTENTS

ASSEMBLY GUIDE.....	02
USING YOUR PRODUCT.....	04

March 27, 2025

QUESTIONS?



E-mail: support@modernshade.org











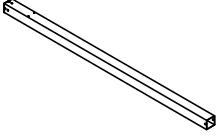
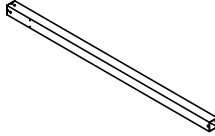
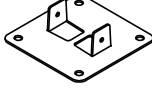
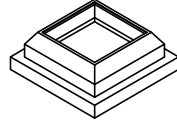
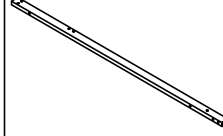
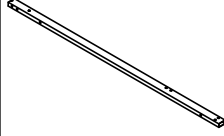
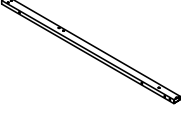
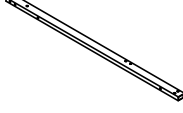
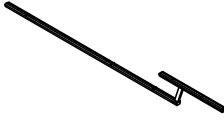
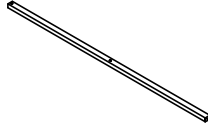
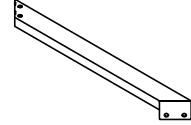
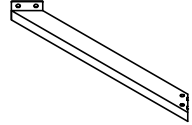
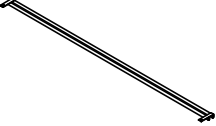
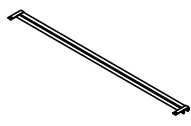
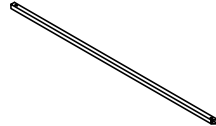
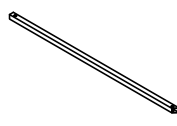

Toll Free: 1-888-666-3070

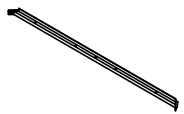

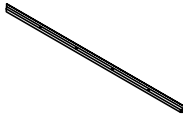
Mon-Fri: 9am---5pm PST.

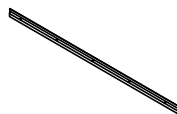
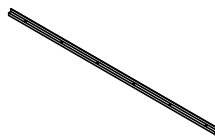
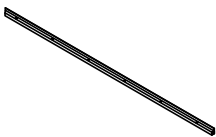
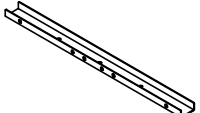
ASSEMBLY GUIDE

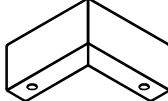
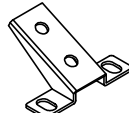
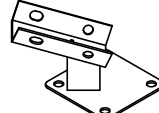
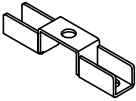
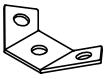
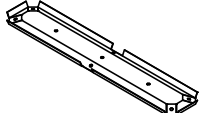
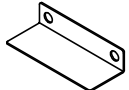
PARTS LIST

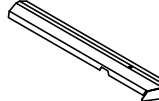
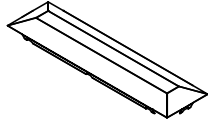
A1 Post 1 (2 pieces) 	A2 Post 2 (2 pieces) 	B Foot Base (4 pieces) 	C Foot Cover (4 pieces) 	D1 Cross Beam 1 (2 pieces) 	D2 Cross Beam 2 (2 pieces) 
P0010000101	P0010000201	P0030000101	P0020000101	P0040000101	P0040000201
D3 Cross Beam 3 (2 pieces) 	D4 Cross Beam 4 (2 pieces) 	E Roof Rib (4 pieces) 	F1 Middle Cross Beam (4 pieces) 	G1 Support Bracket 1 (4 pieces) 	G2 Support Bracket 2 (4 pieces) 
P0040000501	P0040000601	P0070000101	P0080000101	P0050000101	P0050000201
H3 Mosquito Net Rod 1 (4 pieces) 	H4 Mosquito Net Rod 2 (4 pieces) 	J1 Top Beam 1 (4 pieces) 	J2 Top Beam 2 (4 pieces) 	K4 Roof Support 1 (2 pieces) 	K5 Roof Support 2 (2 pieces) 
P0100000401	P0100000501	P0090000101	P0090000201	P0090000901	P0090001001
K8 Roof Support 3 (2 pieces) 	K9 Roof Support 4 (2 pieces) 	K10 Roof Support 5 (2 pieces) 	K11 Roof Support 6 (2 pieces) 	K12 Roof Support 7 (2 pieces) 	K13 Roof Support 8 (2 pieces) 
P0090001301	P0090001401	P0090001501	P0090001601	P0090001701	P0090001801
L1 Connector 1 (4 pieces) 	L2 Connector 2 (4 pieces) 	L3 Connector 3 (4 pieces) 	L4 Connector 4 (4 pieces) 	L5 Connector 5 (4 pieces) 	L6 Connector 6 (8 pieces) 
P0060000101	P0110000101	P0110000301	P0060000301	P0060000401	P0060000501
L7 Connector 7 (12 pieces) 	L8 Connector 8 (1 piece) 	L9 Connector 9 (4 pieces) 	M1 Roof Rib Cover 1 (4 pieces) 	M2 Roof Rib Cover 2 (4 pieces) 	M3 Roof Rib Cover 3 (1 piece) 
P0060000601	P0060000701	P0110000501	P0120000101	P0120000201	P0120000501

ASSEMBLY INSTRUCTIONS

•Please carefully unpack each of the components and hardware. check the components against the parts list and make sure there are no missing parts. lay pieces on cardboard or a soft mat to help protect the pieces from scratches.

⚠ CAUTION

Watch for sharp edges when handling the pieces, wear gloves to avoid injury.

STEP 01 Slide Foot Cover **C** onto Post 1 **A1**. Attach Foot Base **B** using two (2) M6*20 Bolts **AA** and two (2) M6 Flat Washers **DD**. Repeat for the second Post 1 **A1**.

Slide Foot Cover **C** onto Post 2 **A2**. Attach Foot Base **B** using two (2) M6*20 Bolts **AA** and two M6 Flat Washers **DD**. Repeat for the second Post 2 **A2**.

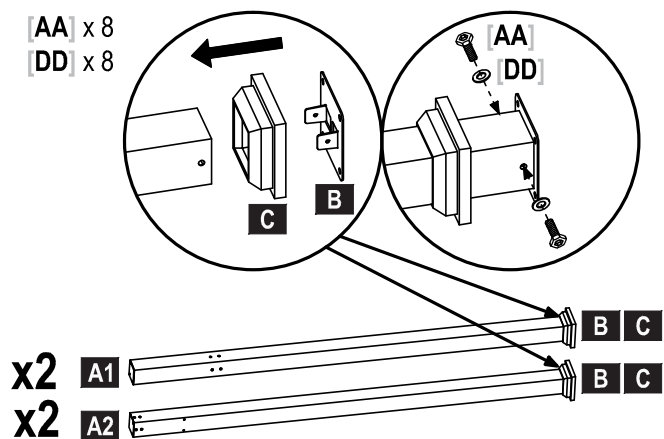

- For ease of assembly, it is recommended to have 3 or more people and allow enough time to completely finish the assembly. assembly can take 6-8 hours. a step-ladder is required for assembly (not included).
- Follow step by step instructions, and follow all safety warnings provided with your tools.
- DO NOT tighten screws until all the screws and washers are properly installed. tighten screws securely, do not over tighten.
- Gazebo should not be used in inclement weather and high winds.

STEP 02 Slide Cross Beam 1 **D1** and Cross Beam 2 **D2** onto the ends of Connector 1 **L1**, then place one (1) Connector 2 **L2** over the middle Connector 1 **L1**. Connect together using five (5) M6*20 Bolts **AA** and five (5) M6 Flat Washers **DD**. Repeat to create a second assembly.

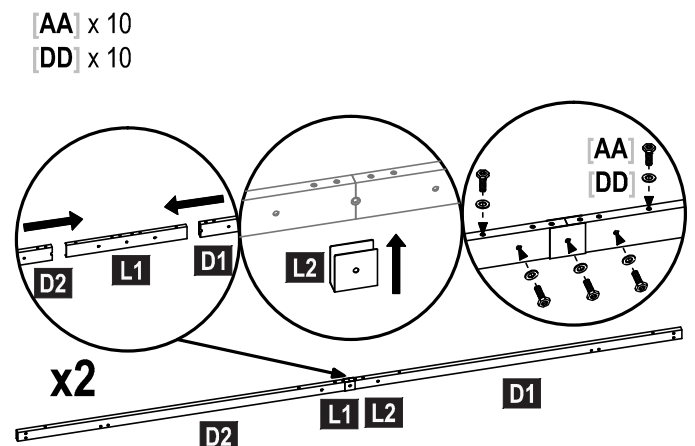

STEP 03 Slide Cross Beam 3 **D3** and Cross Beam 4 **D4** onto the ends of Connector 1 **L1**, then place one (1) Connector 2 **L2** over the middle Connector 1 **L1**. Connect together using five (5) M6*20 Bolts **AA** and five (5) M6 Flat Washers **DD**.

Repeat to create a second assembly.

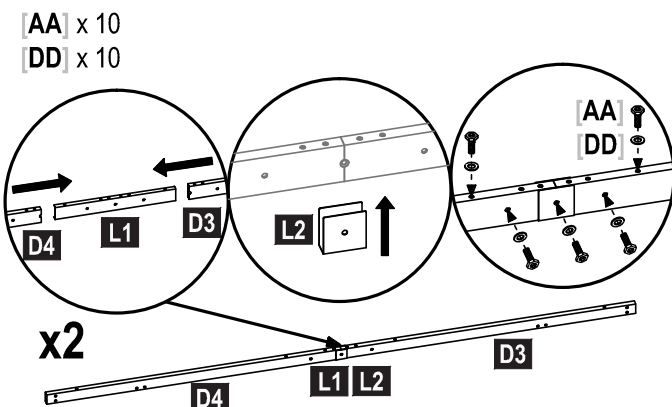

STEP 04 Connect the assembly from Step 2 **D1** + **D2** to Post 1 **A1** and Post 2 **A2** using four (4) M6*20 Bolts **AA** and four (4) M6 Flat Washers **DD**. Repeat to create a second set of legs.

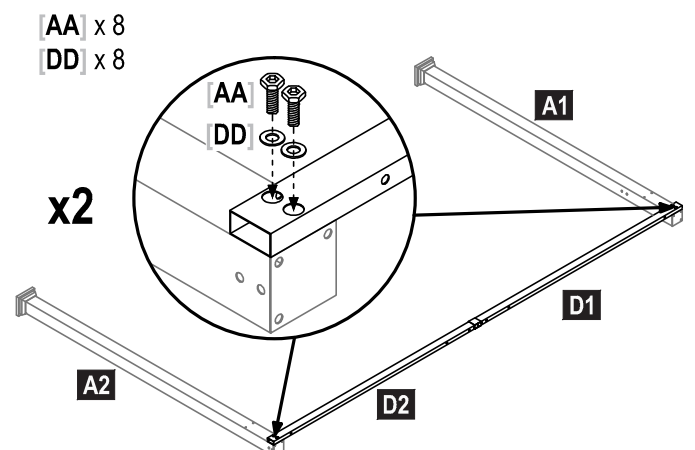

STEP 05 Connect the sets of legs from Step 4 together using the assemblies from Step 3 **D3** + **D4** using eight (8) M6*20 Bolts **AA** and eight (8) M6 Flat Washers **DD**.

AA x 8
DD x 8

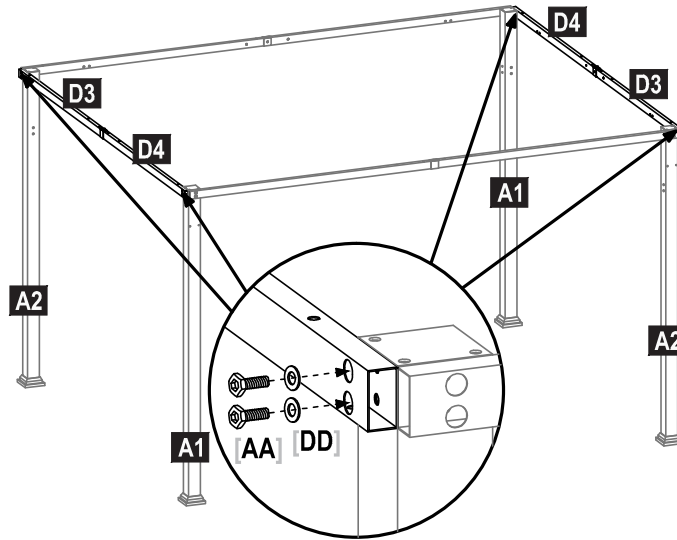

**STEP 06 CRITICAL: SQUARE UNIT BEFORE PROCEEDING TO NEXT STEPS.
ONCE SQUARE, TIGHTEN ALL HARDWARE.**

