

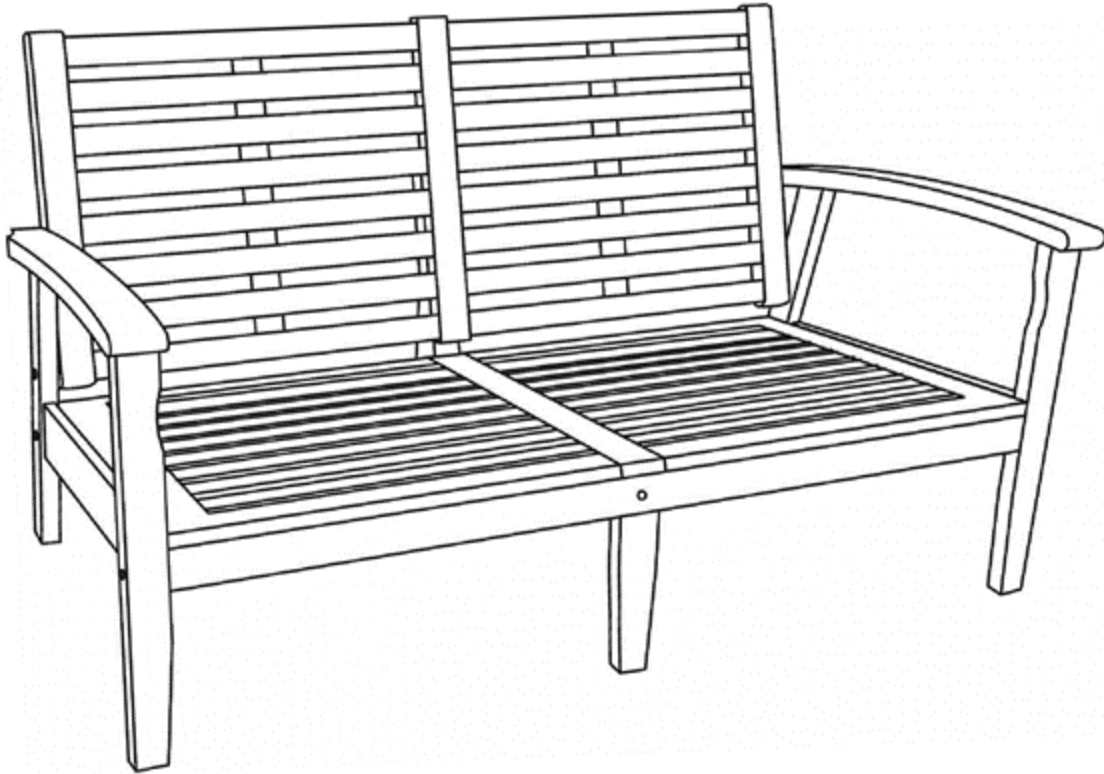

OUTDOOR LIVING



Longs Peak Eucalyptus Settee

Item No. OF-2104, OF-2105, OF-2106, OF-2107

For assistance with assembly, please contact DTYStore.com Customer Satisfaction Center
866-217-8155 . CS@DTYStore.com

Made in Vietnam

Updated V. 3-22

**Thank you for your
DTYStore Purchase!**

We want you to have the best experience possible.

If you have any issues with the assembly,
quality or performance of your product

**PLEASE CONTACT OUR CUSTOMER CARE CENTER
BEFORE YOU RETURN IT.**

Email us at: CS@DTYStore.com







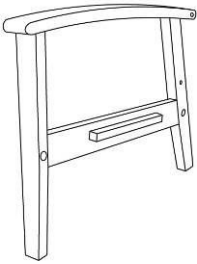
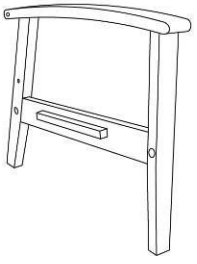
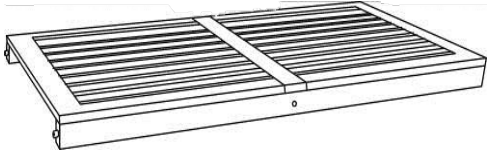
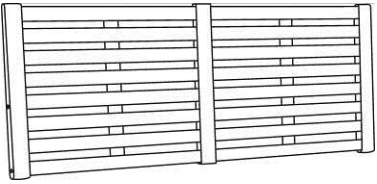
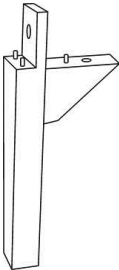
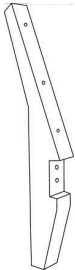

Pre-Assembly Instructions

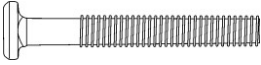
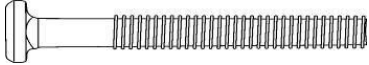
- Read all instructions carefully before assembly.
- Find a smooth clean area in which to work to avoid damaging your item.
- Check that all parts and hardware from the lists are present.
- Lay out parts in alphabetical order and hardware in numerical order to make them easier to find when you are ready to assemble
- Wait to dispose of packing material until assembly is complete to avoid accidentally disposing of small parts or hardware
- Tools required: Allen wrench (included) Phillips screwdriver (not included)
- Please use caution and care when lifting the product to avoid injury
- For ease of assembly two people are recommended

Parts List:

| | | | |
|---|--|---|---|
| <p>A. Right Leg Qty: 1</p>  | <p>A. Left Leg Qty: 1</p>  | <p>C. Seat Qty: 1</p>  | |
| <p>D. Back Qty: 1</p>  | | <p>E. Front Leg Qty: 1</p>  | <p>F. Back Leg Qty: 1</p>  |

Hardware list:

| | | |
|--|---|---|
| <p>1. Short Bolt Qty: 2</p>  <p>Size 6x70mm</p> | <p>2. Long Bolt Qty: 3</p>  <p>Size 6x90mm</p> | <p>3. Nut Qty: 5</p>  <p>Size</p> |
| <p>4. Medium Screw Qty: 5</p>  <p>Size 6x60mm</p> | <p>5. Short Hex Screw Qty: 2</p>  <p>Size 6x35mm</p> | <p>6. Pin Qty: 1</p>  <p>Size</p> |
| <p>7. Long Hex Screw Qty: 2</p>  <p>Size 6x50mm</p> | <p>8. Long Screw Qty: 1</p>  <p>Size 6x80mm</p> | <p>9. Allen Wrench Qty: 2</p>  <p>Size 4mm</p> |

Assembly Instructions:

Step 1:

Use a Short Bolt (1), Long Bolt (2), Nut (3) and Allen Wrench (9) to loosely attach the Seat (C) to the Right Leg (A). *Wait to fully tighten all hardware until the end of Step 4.*

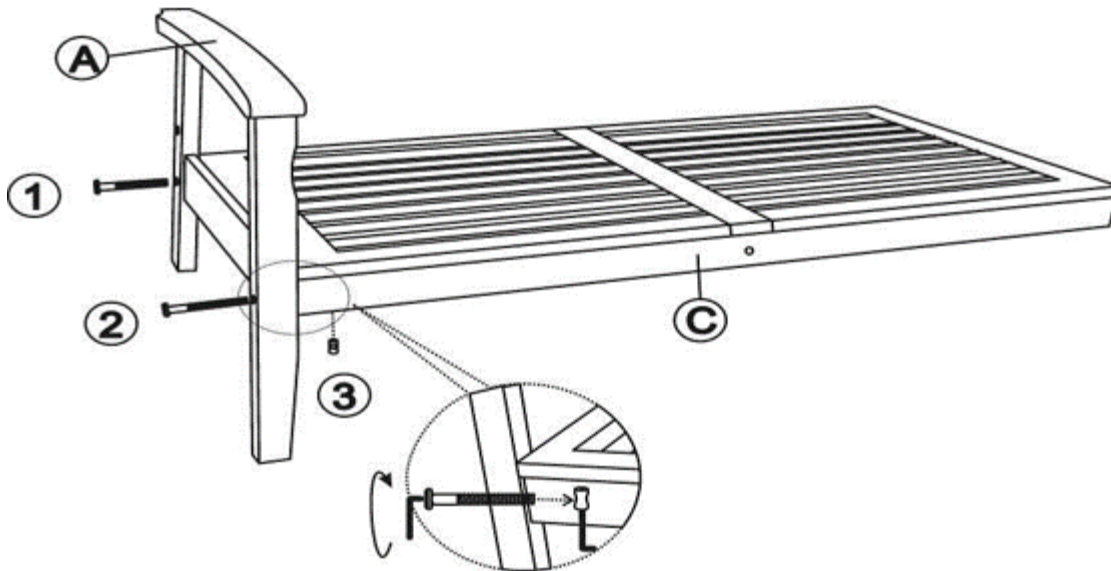

Step 2:

Use a Short Bolt (1), Long Bolt (2), Nut (3) and Allen Wrench (9) to loosely attach the Seat (C) to the Left Leg (B).

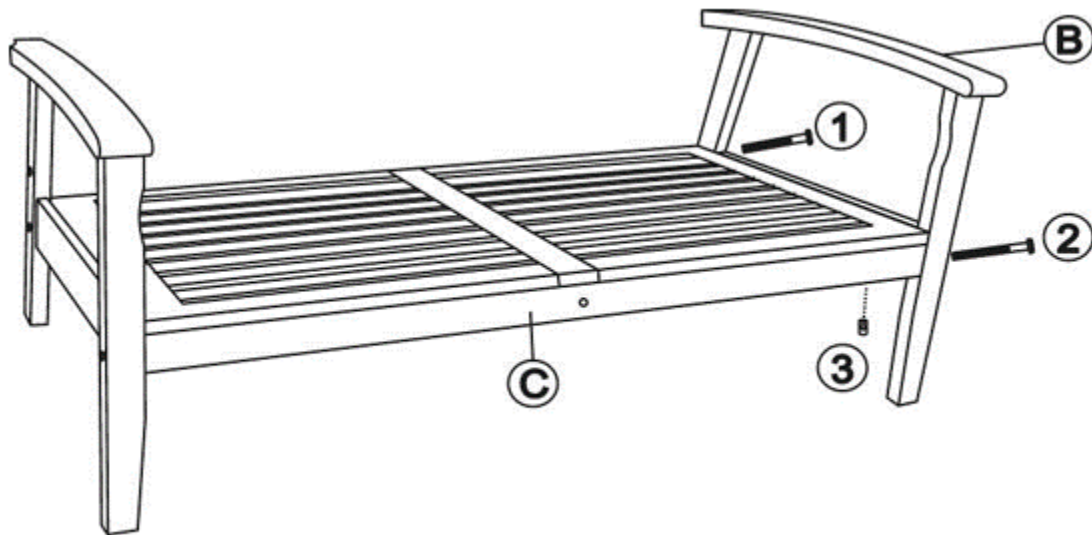

Step 3:

Use Medium Screw (4) and Allen Wrench (9) to attach the Back (D) to the Right Leg (A) and the Left Leg (B).

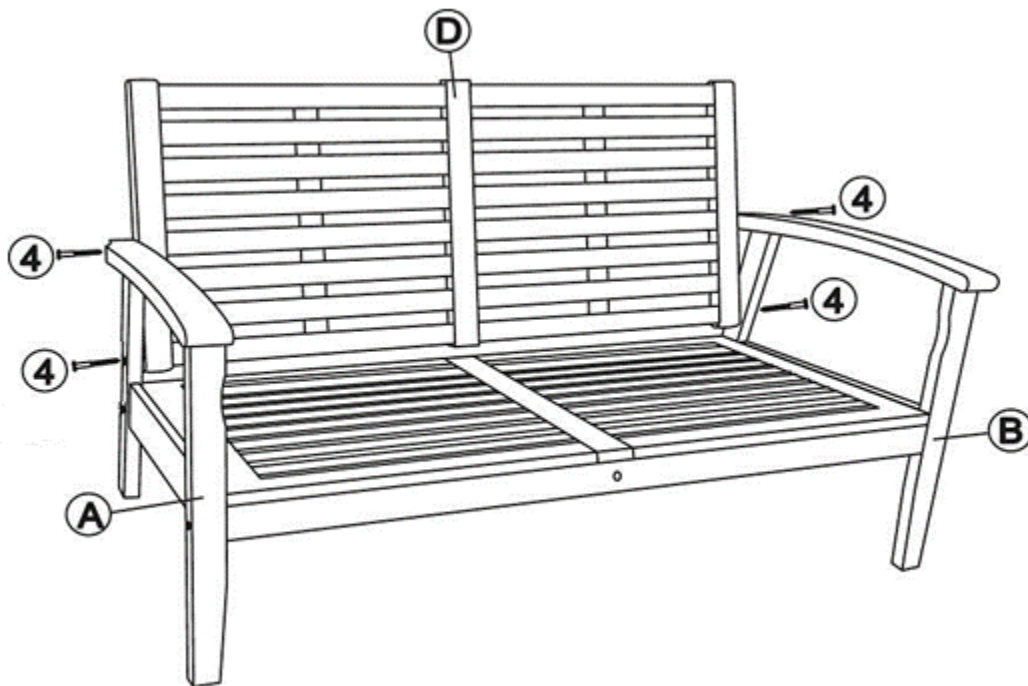

Step 4:

Use Short Hex Screws (5) to secure the support rail on the Sides to the Seat. Fully tighten all Bolts and Screws.

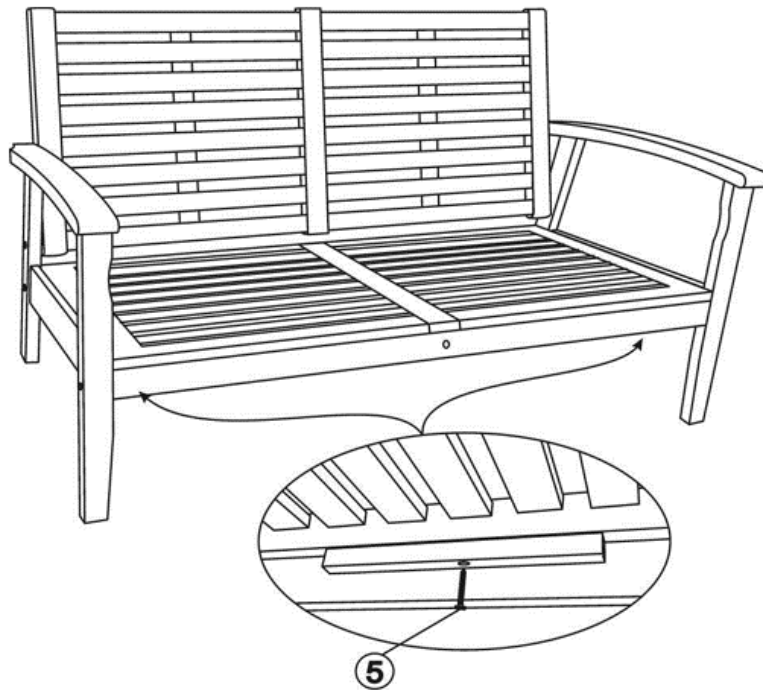

Step 5:

Place Front Leg (E) in the center of the seat frame lining up the holes. Insert the Pin (6) into the hole in the seat until it enters the hole in the Front Leg. You may need to tap it with a soft mallet, or by tapping a block of wood over the Pin. Use a Medium Screw (4) and Hex Wrench (9) to attach the Front Leg (E) to the Seat (C).

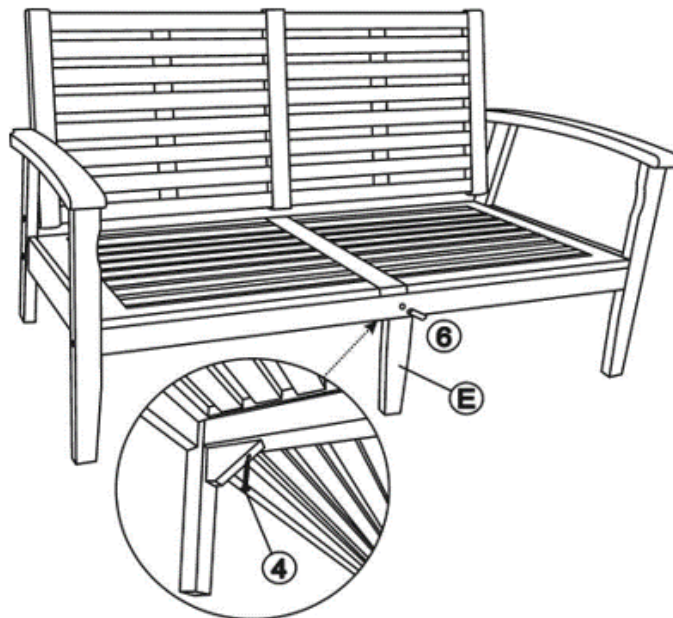

Step 6:

Use the Long Bolt (2) with Nut (3), Long Screw (8), Long Hex Screw (7), and the Hex Wrench (9) to attach the Back Leg (F) to the Seat.

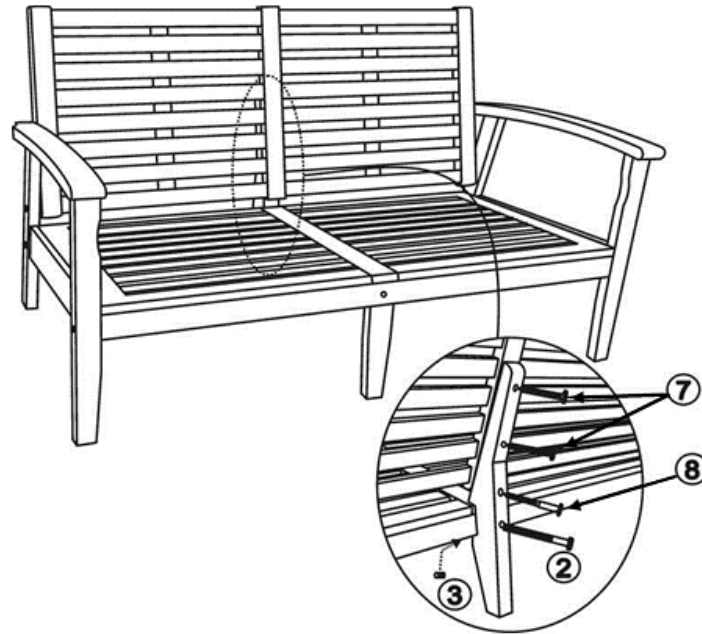
**Post-Assembly Instructions:**

- Periodically check hardware to be sure it does not loosen over time.
- Do not stand on this item.

Outdoor Furniture Care Tips:

With the proper care, your premium eucalyptus furniture can last up to 25 years or more. Our eucalyptus outdoor furniture is available in 3 different finishes. Our Natural oil and espresso finishes are a transparent oil finish designed to let the beautiful grain of the eucalyptus show through. Our driftwood gray finish is a painted distressed finish made to look like weathered eucalyptus. Like any investment care and maintenance play an important role in how well and how long your Eucalyptus furniture will last. There are several ways to care for your Eucalyptus furniture depending on the finish and the look that you want.

Oil Finished Eucalyptus Furniture Care:

To maintain the color and finish of your Eucalyptus furniture it is possible to preserve the look with a little care.

- Clean your furniture using a soft bristle brush and mild soap and water. You may also clean it with a teak cleaner. Rinse well with clean water after washing.
- Do not use a power washer as it can damage the surface of your furniture causing it to splinter.

- Do not use steel wool or brass wool it is too abrasive and can leave a residue that will leave rust spots on your furniture.
- Furniture with an oil finish can be treated annually with a Teak sealer to help seal in the natural eucalyptus oils and protect it further from the elements. The sealer also provides UV protection and will help maintain the finish.
- Furniture with an oil finish can also be treated with a good quality Teak Oil if you do not want to use a sealer. Teak oil can be applied as often as needed depending on how much exposure to the elements your furniture receives. Teak Oil will restore the shine from the oil finish and help retain the golden color of the furniture.
- We recommend you protect your furniture in the offseason by using good quality furniture cover. It helps keep your furniture clean and protects it from the elements and minimizes annual maintenance.

Painted Outdoor Eucalyptus Furniture Care:

To maintain the color and painted finish of your Eucalyptus furniture it is possible to preserve the look with a little care.

- Brush off any loose dirt or debris with a soft brush and wipe down with a mild detergent and water. Rinse well with clean water after washing.
- Do not use a power washer as it can damage the surface of your furniture causing it to splinter.
- Do not use steel wool or brass wool it is too abrasive and can leave a residue that will leave rust spots on your furniture.
- We recommend you protect your furniture in the offseason by using good quality furniture cover. It helps keep your furniture clean and protects it from the elements and minimizes annual maintenance.

Natural Weathered Eucalyptus Furniture Care:

Exposed to the elements eucalyptus will acquire a silver-gray patina. To obtain the patina leave the furniture outdoors in the sunlight without treating it with a teak sealer or teak oil and it will begin to develop the silver-gray patina. During the weathering process, a slight lifting of the grain may occur, and you may even see a few cracks. This is not considered a defect, but a natural process of the wood expanding and contracting.

To care for Weathered Eucalyptus:

- Lightly sand the surface of the furniture with 150 or 180 grit sandpaper once a year to remove any fuzziness that occurs due to exposure to the elements. Be sure to sand lightly to retain the natural patina.
- Clean as needed with a soft bristle brush and mild soap and water. You may also clean it with a teak cleaner. Rinse well with clean water after washing.
- Do not use a power washer as it can damage the surface of your furniture causing it to splinter.
- Do not use steel wool or brass wool it is too abrasive and can leave a residue that will leave rust spots on your furniture.

We recommend you protect your furniture in the off season by using a using a good quality furniture cover. It helps keep your furniture clean and protects it from the elements thus minimizing annual maintenance.