

### Features:

- Hand-held round shower head with three function variable spray
- Includes 59" flexible hose
- Hook and intake sold separately
- Easy -clean nozzles
- Outfitted with a 1.75GPM flow regulator, with backflow prevention, max. flow rate: 1.8GPM

### Finish Options:

- CR - Polished Chrome
- PN - Polished Nickel
- NI - Brushed Nickel
- BG - Brushed Gold
- 44 - Matte Black

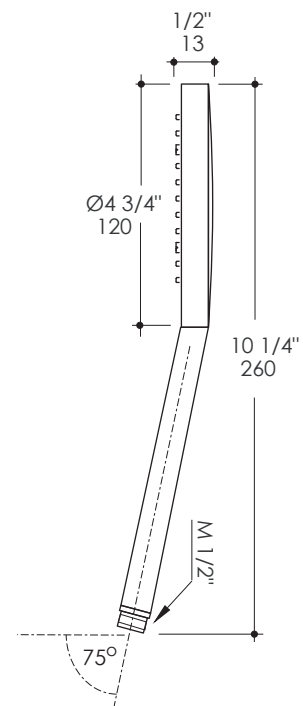

### Codes + Standards:

- Meets and exceeds applicable national codes
- Meets Cal-green requirement
- Complies with CEC standard



### Recommend Accessories:

- Item # 1570: Wall-mount rail with hook for hand-held shower head
- Item #1573A: Water intake
- Item#1563: Water intake with a hook

LACAVA reserves the right to revise any dimension or information on this sheet without notice. Dimensions are nominal and may vary within an industry accepted tolerance of 1/4". Drawings provided herein are meant to give the user an idea of the product and are not made to scale. Location of plumbing is meant for reference, your specific application may vary.

Revised: 4/14/2022