

COSIEST[®]

C0150518 Fire Table

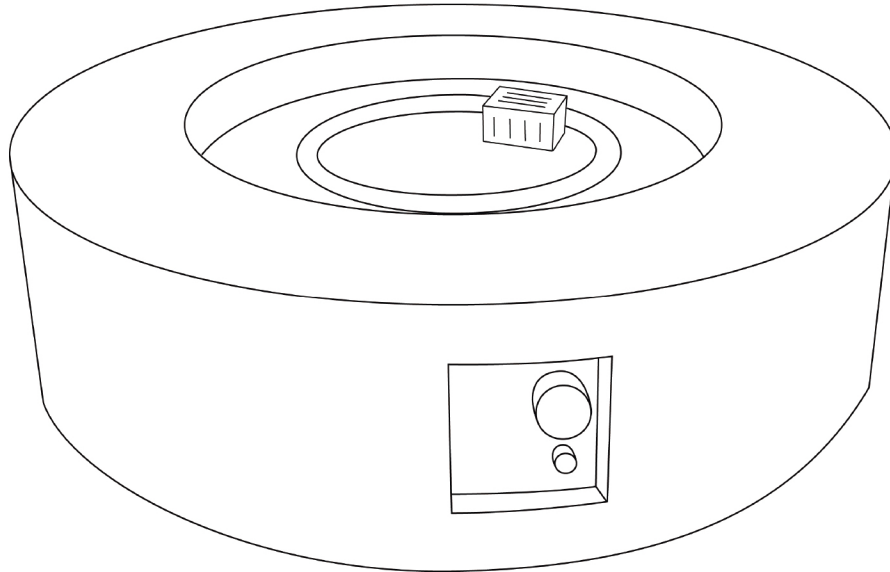

Thank You for Choosing COSIEST !

Our goal is to provide high quality outdoor furniture with outstanding customer service-all at an affordable price.

Please let us know how we are doing!

Problems?

We will fix it immediately.

✉ help@icosiest.com 【24/7】

☎ (909) 312-3668 【9AM-5PM(PT) Monday to Friday】

As a valued customer, your satisfaction is our #1 priority!

Happy?

How satisfied are you with our products? Your comments mean a lot to us!

Find more awesome deals on www.icosiest.com

For latest information, follow us on [facebook.com/icosiest](https://www.facebook.com/icosiest)

For daily design inspirations, like us on

[instagram.com/icosiest_furniture/](https://www.instagram.com/icosiest_furniture/)

CONTENTS

- Warnings 1-4
- Diagram..... 5-6
- Assembly..... 7-8
- Operation9-10
- Maintenance & Storage 11
- Trouble Shooting 12-13
- Warranty Information.....14

Warnings

DANGER

CARBON MONOXIDE HAZARD

- This appliance can produce carbon monoxide which has no odor. Using it in an enclosed space can kill you.
- For outdoor use only.
- Never use in the unventilated or enclosed areas.

IF YOU SMELL GAS:

- Shut off gas to the appliance.
- Extinguish any open flame.
- If odor continues, keep away from the appliance and immediately call your gas supplier or fire department for help.

WARNING

- WARNING indicates an imminently hazardous situation which, if not avoided, will result in death or serious injury.
- Do not store or use gasoline or other flammable vapors and liquids in the vicinity of this or any other appliance. An LP-cylinder not connected for use shall not be stored in the vicinity of this or any other appliance.

WARNING

- If the propane gas tank is leaking gas, you may hear, see, or smell a hiss. Do the following:
 1. Disconnect the propane gas tank.
 2. Do not attempt to fix the problem by yourself.
 3. Contact your gas supplier or fire department for help.
- Do not use a flame to check for gas leaks.
- Keep gas tank at least 5 ft away from unit when lit. (if external tank)
- The maximum gas supply pressure is 250psi.

WARNING

- Improper installation, adjustment, alteration, service or maintenance can cause injury or property damage.
- Read the owners manual thoroughly before installing or servicing this equipment. If the information in this manual is not followed exactly, a fire or explosion may result causing property damage, personal injury, or loss of life.

Warnings

WARNING

- The installation of this unit must adhere to local codes or either the National Fuel Gas Code, ANSI Z223. 1/NFPA54, OR CAN/CGA- B149.1, National Gas and Propane Installation Code.
- This unit is to be used with propane gas only! (sold separately), is not intended for natural gas.
- Do not use any solid fuel or charcoal for this unit.
- Do not use any more than 1/4in depth lava rocks/ pumice stones/ Lava Glass above the burner holes. Doing so will suffocate the flame.

WARNING

- Applying too much propane may result in gas pooling and will not burn. Allow fresh air into the unit so that the remaining gas may escape.
- Use LP propane tanks with the following dimensions: diameter 12inch, height 18inch, capacity 20lbs.
- You must use a propane tank that has a collar to protect the gas valve.
- DO NOT fill tank over 80 Percent full.
- The LP gas tank must have a listed overfilling prevention device and a QCCI or Type I, (CGA810) LP gas tank connection.
- The gas supply tank should be constructed and marked with the specifications for the LP gas tanks of the U.S. Department of Transportation or the National Standard of Canada CAN/CSA-B339, LP gas tanks, spheres and tubes for Transportation of Dangerous Goods and Commission.
- Discontinue use if any part of the propane tank is damaged. Rust and dents may be hazardous and should be inspected by a gas supplier.

Warnings

WARNING

- DO NOT add water into the unit.
- DO NOT disconnect any part while the unit is in use.
- DO NOT operate on a boat or vehicle.
- DO NOT set the Protective Cover over the unit until the Fire Table / Column is turned off and completely cooled down (where applicable).
- Check for leaks after not using the unit for long periods of time.

WARNING

- All installation and repair should be done by a Qualified Service Technician. This unit should be inspected annually and cleaned regularly.
- Inspect all elements of this Fire Table / Column before each use.
- If there is damage, the Burner must be replaced.
- The LP Gas tank must have a listed overfilling prevention device and a QCCI or Type I, LP Gas tank connection.
- Keep the appliance area clear and free from combustible material, gasoline and other flammable vapors and liquids.
- Be aware of the hazards of high temperatures and stay away from the unit to avoid any burns or injury.
- This heating appliance should NOT be used on plastic, artificial wood desks or any desk.

Warnings













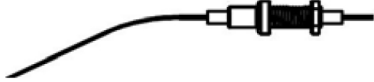

WARNING

- Do not operate unit until all parts are fully assembled.
- Do not attempt to move it while in use.
- This unit is not intended for cooking.
- Young children should be carefully supervised when they are in the area of the appliance.
- Keep away from the unit for the first 20 minutes after igniting for the first time, as lava rock /pumice stones could pop out and cause injury.
- Do not set the protective cover over the unit until it is turned off and completely cooled down.
- Combustible material should not be within 72 inches of the top of the unit, or within 48 inches around the entire unit.
- If the flame goes out while burning, turn the gas valve off. Wait 5 minutes before repeating the initial lighting procedure. Once you have a flame started, hold down the control knob for 1 minute.

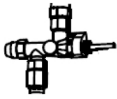
WARNING

- Inspect all elements of this heating unit before each use. If there is damage, the burner must be replaced.
- Keep the hose out from any pathways to eliminate any accidental damage. (if external tank)
- Installation and repair should be done by a qualified service person. The appliance should be inspected before use and at least annually by a qualified service person. More frequent cleaning may be required as necessary.
- You must follow all steps to properly assemble this heating item. Make sure the gas valve is turned "OFF" before assembling. Do NOT attempt to assemble without proper tools.

Parts Diagram

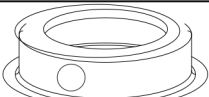
Item	Picture	Description	Qty
01		Guard	1
02		Themocouple	1
03		GroundWire	1
04		Ignition Pin	1
05		Burner Plate	1
06		Main Frame of Fire Table	1
07		Lava Rock	1
08		Burner	1
09		Nozzle	1
10		Corrugated Pipe	1
11		Swithing Valve	1
12		Regulator Valve with Gas Hose	1
13		Control Knob	1
14		Igniter	1
15		Foot Pad	4
16		ETL Warning Label	1
17		Wing Screw with Nut	1
18		Metal Stand	1

Parts List

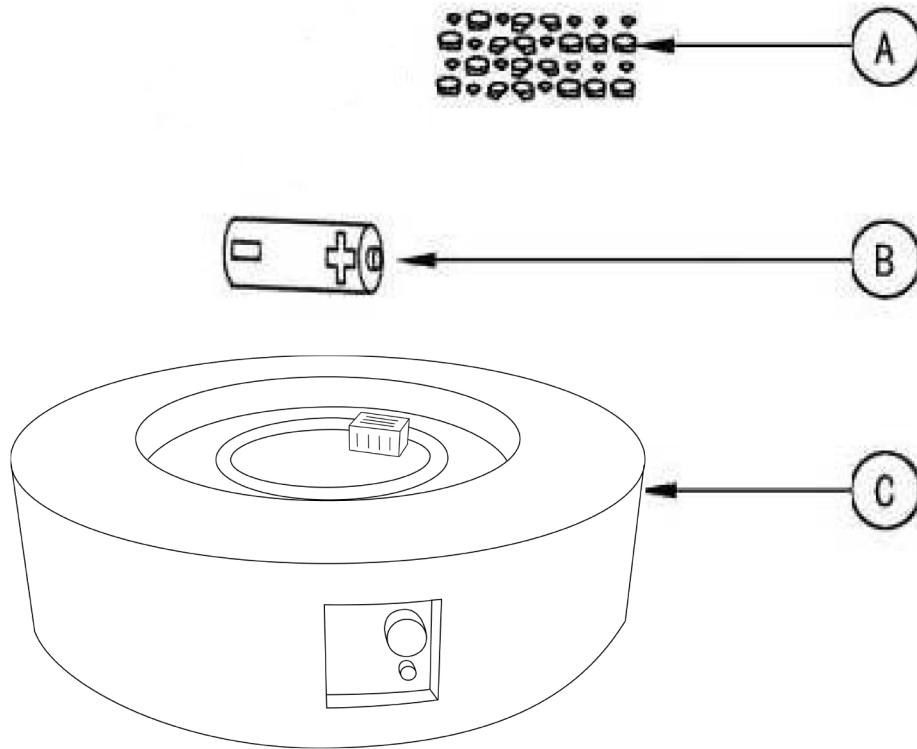

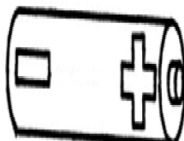
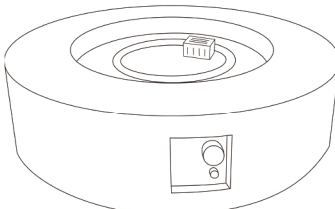
Item	Picture	Description	Qty
A		Lava Rocks	1 box
B		AA Battery	1 pc
C		Main Frame of Fire Table	1 pc

Assembly Instructions

Step 1:

Check that the control knob (13) for the gas supply system is turned to the "OFF" position before starting any assembly.

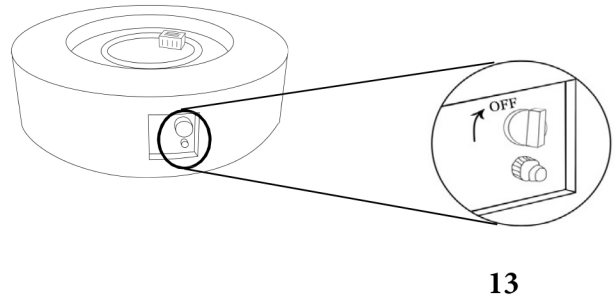

Step 2:

Place a 20 lbs Propane Gas Tank (not included) into the Metal Stand (18).

Make sure the Propane Gas Tank is placed completely into the Metal Stand.

Turn the preassembled Wing Screw (17) in a clockwise direction in to the Nut to secure the Propane Gas Tank tightly.

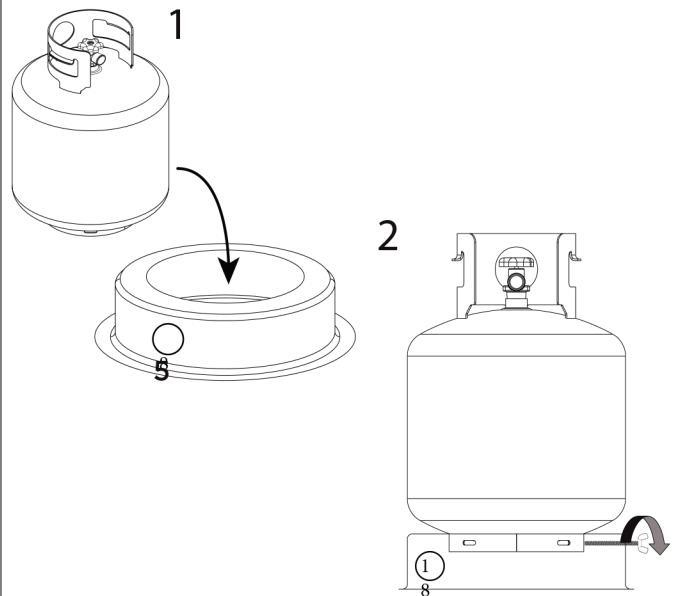

Step 3:

Turn the Cylinder Valve (21) on the tank clockwise direction to TURN OFF SUPPLY of the LP Gas supply.

Attach the preassembled Regulator (12/19) from the Fire Table to the Cylinder Valve (21) by turning the Black Regulator Coupling Nut (20) clockwise.

Make sure it is fastened securely and tighten connections-by HAND only.

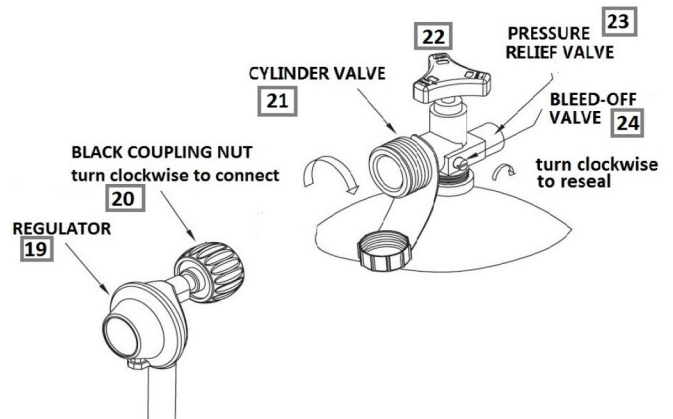

Assembly Instructions

Step 4:

Remove the Electronic igniter Cap on the Electronic igniter (14) by unscrewing and slide the Battery (B) into the battery slot. Make sure the positive side of the Battery (B) faces outwards. Screw the Electronic Igniter Cap (14) over the battery, tightly.

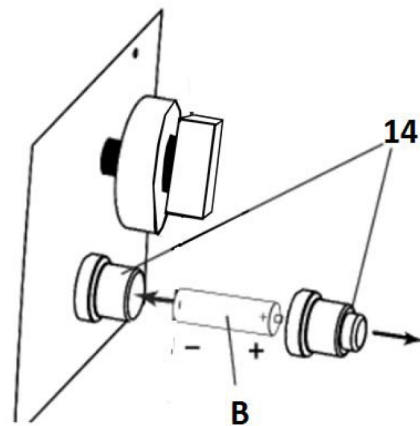

Step 5:

pour Lava Rocks over the Burner Ring.

The Guard **MUST NOT BE BLOCKED**. Do not place more than 1/4 inch depth of lava rocks above the burner holes. Do not place more than 13.2lb of lava rocks above the burner holes.

WARNING: Fire Table and LP-Cylinder must be at a minimum of 60 inches apart.

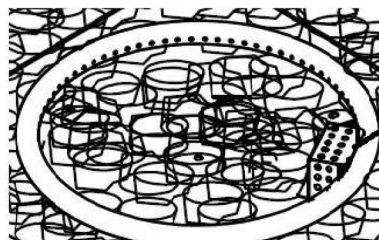
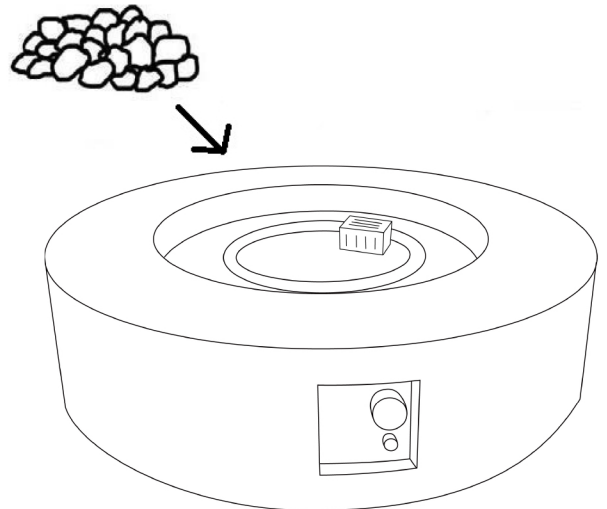

Guard
DO NOT PLACE LAVA ROCKS ON THE
GUARD. KEEP GUARD CLEAN.

WARNING: To ensure proper function, the Guard (01) on the Burner (08) should never have lava rocks (A) covered over it.

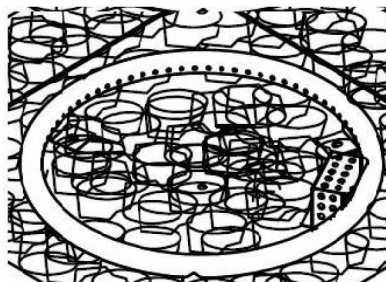

CORRECT

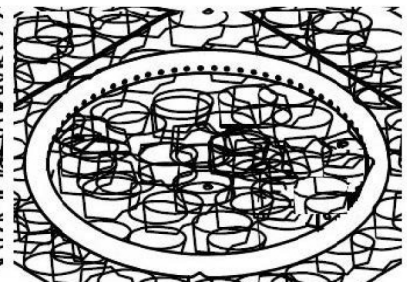

INCORRECT

Operation

FOR YOUR SAFETY, READ BEFORE LIGHTING

- Before performing a leak test, make sure that no sparks can occur and you are in a spacious outdoor area.
- Connect the propane gas tank to the regulator and turn the valve on the unit to the "off" position.
- Brush a soap and water mixture on all connections.
- Make sure the igniter battery has been installed properly. The igniter will not operate otherwise.
- Before operating, smell around the appliance and next to the ground for gas odors. If you smell gas or a leak is discovered turn the gas valve off, disconnect propane gas tank and do not use the appliance until the leak is repaired.
- If there are signs of wear or abrasion on the hose, you must replace the Gas Hose. And the Gas Hose must be supplied directly by manufacturer.
- Stand away from the Fire Table / Column for the initial 20 minutes after igniting.
- Lava rocks / pumice stones could pop up and strike somebody's face during the process of lighting this unit.
- Pumice stones/lava rocks/Lava Glass could pop up and strike somebody's face during the process of lighting this unit; Wait 10 minutes after extinguishing flame prior to replacing a lid (if applicable) or protective cover onto the Fire Table.

Operation

Using Your Fire Table

1. Make sure the Control Knob (13) is in the "OFF" position.
2. Open the Door and slowly open the Valve (22) on the Propane Gas Tank by turning the Control Knob (13) counterclockwise.
3. Push and hold in the Electronic Ignition to create sparks within the electrode continue to hold.
4. Push in the Control Knob (13) and turn to the "LOW" position. Keep holding down the Control Knob (13) to allow gas to flow for 15 seconds.
5. If ignition doesn't occur within a few seconds release the Control Knob (13) and rotate to the "OFF" position. Wait for 5 minutes for gas to clear and then repeat the above lighting instructions.
6. Once the Fire Table / Column is lit, the flame intensity may be controlled by turning the Control Knob (13) between the "LOW" and "HIGH" positions



2 inches to 10 inches

8. Observe flame height when lit:

- 1) Flame color should be yellow / blue.
- 2) Flame height burns at 2 - 10 inches high.

NOTE: Whenever gas connections are loosened or removed, you must perform a complete leak test. Complete installation.

Maintenance & Storage

To enjoy years of outstanding performance from your heater, make sure you perform the following maintenance activities on a regular basis:

- Before performing any maintenance always disconnect propane gas tank.
- Use warm soapy water for cleaning. Never use flammable or corrosive cleaning agents.
- DO NOT use petroleum-based or abrasive cleaning products.
- DO NOT use any harsh brushes/rough sponges when cleaning the Fire Table/Column surface.
- DO NOT place any food on the surface of the Fire Table/Column.
- DO NOT eat from the surface of the Fire Table/Column surface.
- Blot any liquid spills with a clean, dry cloth to avoid spreading of the spill to the rest of the table. Immediate cleaning of stains/blotting of spills also prevent absorption of such stains/spills into the surfaces, compared to if such stains are left for extended periods on these surfaces.
- Cover your product with an outdoor Protective Cover when not in use to protect it from the elements.
- Avoiding extreme cold temperatures, as extreme cold temperatures may cause cracking of the table top.
- Always place lid (if applicable) or protective cover on heating item when not in use. Turn control knob OFF.

NOTE: In a salt-air environment (such as near to ocean), corrosion occurs more quickly than normal. Frequently check for corroded areas and repair them promptly.

Trouble Shooting

PROBLEM	CAUSE	SOLUTION
Burner will not light using igniter	Electrode and burners are wet	Wipe dry with cloth.
	Igniter battery is dead or backwards	Check that the battery is inserted correctly in the igniter or replace the battery. Make sure the plastic wrap on the battery has been removed.
	Igniter Pin cracked or broken - sparks a crack	Please contact Living source to request the parts.
	Residue on Igniter Pin	Check for residue on the igniter pin or Thermocouple. If dirty, thoroughly clean the area. Check that the electronic Igniter Cap is tightly fitted to the spring. If loose, please adjust the spring accordingly.
Burner will not light with match	No Gas Flow	Check if the LP gas tank is empty. If empty, replace and refill. If the propane tank is not empty, refer to Problem: Sudden drop in gas flow on the following page.
	Coupling nut and regulator not fully connected	Turn the coupling nut about one half to three fourths a turn, until you feel a solid stop. Do not use tools, tighten by hand only.
	Obstruction of gas flow	Check for bent or kinked hose.
	Spider webs or insect nest in the venturi	Clean the venturi.
	Burner ports clogged or blocked	Reference Problem: Irregular flame pattern on the following page. Clean the burner ports as described there.
The fire table emits a lot of black smoke when in use	Hose from gas fire table is pinched	Make sure the hose is not pinched between the fire table and the source of the gas.
	Flame is being obstructed at burner ports or mixing chamber of the burn tube is blocked or obstructed	Make sure that the gas ports on the burner are free of any lava rocks/fire glass so that the flame can flow naturally. Clear out the mixing chamber located before the Venturi.
Sudden drop in gas flow, or a reduced flame height	Out of Gas	Check for gas in the LP gas tank.
	Excess flow safety device may have been activated	Turn control knob to OFF, wait 30 seconds and light outdoor fire table. If flames are still too low, reset the excessive flow safety device by turning off the control knob and LP gas tank valve. Disconnect regulator. Turn burner control knob to HIGH. Wait at least 5 minutes. Turn burner control knob off. Reconnect regulator and perform a leak check at tank connection. Turn LP gas tank valve on slowly, wait 30 seconds and then light outdoor fire table.
Irregular flame pattern, flame does not run the full length of the burner	Burner ports are clogged or blocked	Clean burner ports. Do this by inserting a paperclip into each of the burner ports to ensure they are not clogged. WARNING: Make sure burner is not on, and has had sufficient time to cool before touching it.
Flame blow out	High or gusting winds	Increase flame to HIGH setting.
	Low on LP gas	Replace or refill LP gas tank.
	Excess flow valve tripped	Refer to Problem: Sudden drop in gas flow.
Flame seems to lose heat when burning in cold weather - temperature below 50°F	Ice has built up on the outside of the LP gas tank because the vaporization process is too low	Turn the control knob and the LP gas tank to OFF. Replace with a spare LP gas tank and resume burning. Store the spare LP gas tank in a well ventilated area, away from children.

Trouble Shooting

Problem: Burner JUST LIGHT UP FOR SECOND AND WILL AUTOMATICALLY TURN OFF

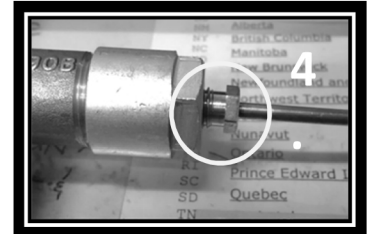
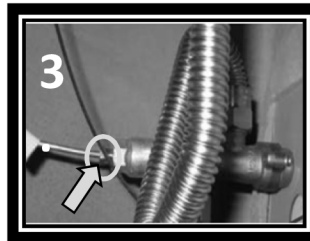
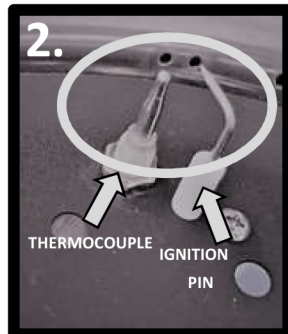
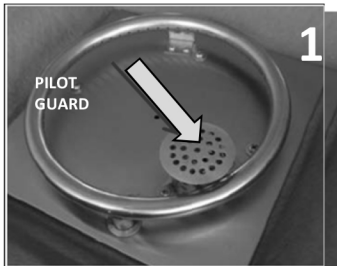

1. The thermocouple will be under the Pilot Guard on the top of the unit. Please remove the Pilot guard by unscrewing it from the metal bowl with a screw driver.
2. Once the Pilot Guard has been removed, you will have two components exposed; the copper one is your thermocouple. Please unscrew the nut holding the thermocouple in place.
3. Inside the unit, you will notice that the end of the thermocouple line is directly screwed to the gas valve. Please unscrew the thermocouple from the back end of the gas valve. Do not take off the valve's silver backing, only unscrew the small nut as shown above.
4. Screw the end of the thermocouple to the back end of the gas valve with the silver backing.

Once this has been done, please test the unit. You may have to reset the gas valve once again as the safety mechanism may have been set off by the new components introduced:

Resetting Your Gas Valve

Completely detach the propane tank from the table. Do not forget to turn the propane tank valve down. Turn the heat knob to high and leave it on that setting for about two to three minutes.

Once you have done this, please turn the knob back to off. Hook up the propane tank and turn the propane tank's valve a quarter of a turn at a time.

NOTE: When reattaching the propane tank, please turn the valve to release the gas back in to the unit VERY SLOWLY. We want the unit to register gas coming through but not too much at once, this will flood the unit and you will have to start all over!

This is so that the gas valve can register the gas coming through a little at a time. Once you have turned the gas on all the way please go ahead and try to light the table again. This should reset your fire table's safety mechanism

Warranty Information

This product has been manufactured under the highest standards of quality and workmanship.

We warrant to the original consumer that all aspects of this product will be free of defects in material and workmanship for one year from the date of purchase. A replacement for any defective part will be supplied free of charge for installation by the consumer. Defects or damage caused by the use of other than genuine parts are not covered under this warranty.

This warranty shall be effective from the date of purchase as shown in the purchase receipt.

The manufacturer warranty will be voided by, and manufacturer disclaims any responsibility for, the following actions but not limited:

- Modification of the unit and/or components including the gas valve assembly.
- Use of any component part not manufactured or approved by Bond Manufacturing.
- Use and installation other than what is listed in this manual.

Need help?
help@icosiest.com

Look for other patio furniture?
www.icosiest.com

Search for outdoor furniture tips?
facebook.com/icosiest