

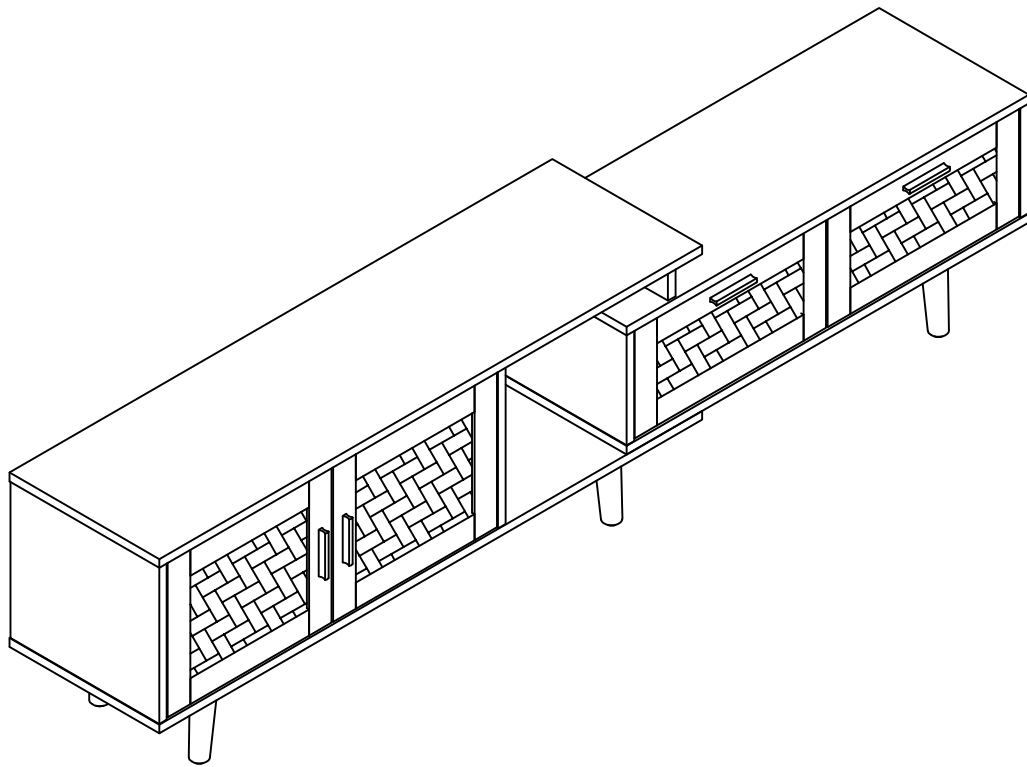

Assembly Instruction

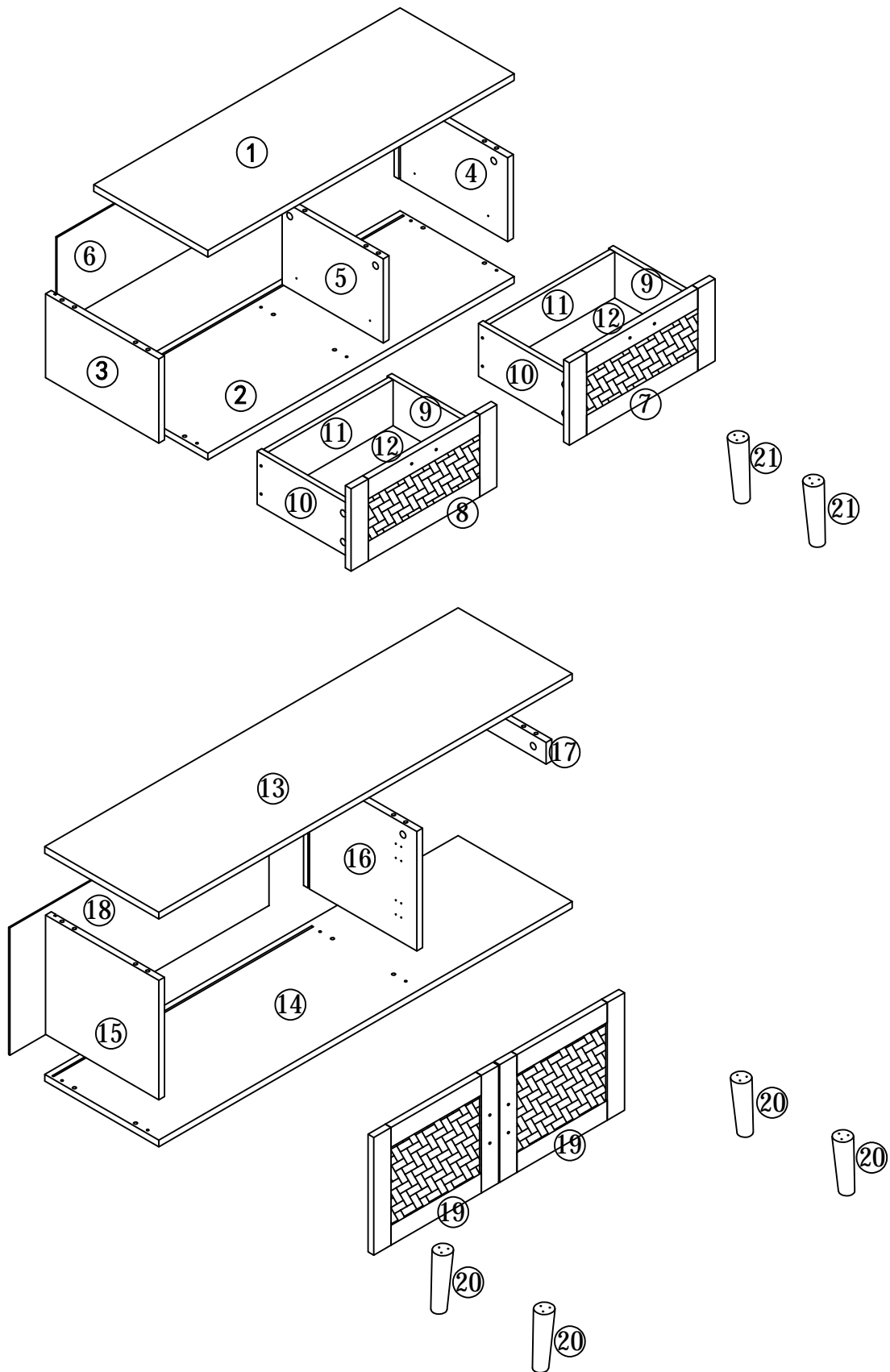

BOARD IDENTIFICATION

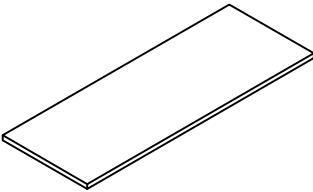
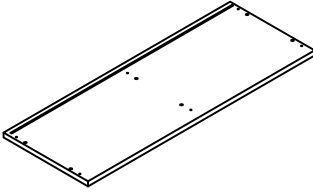
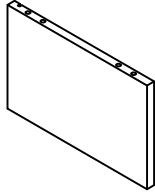
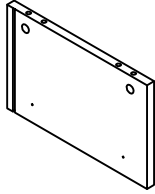
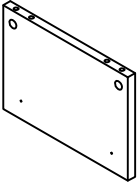
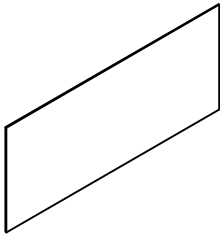
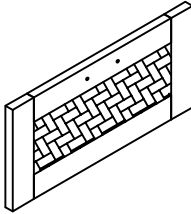
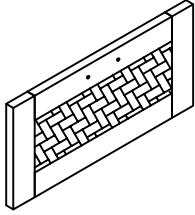
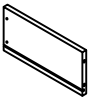

BOARD IDENTIFICATION

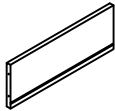
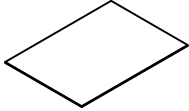
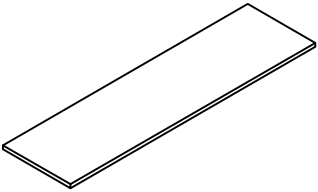
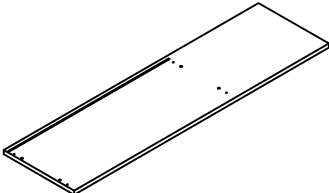
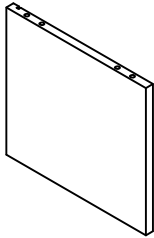
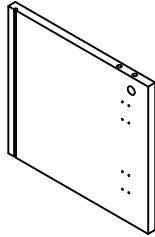
 <p>①x1</p>	 <p>②x1</p>	 <p>③x1</p>	 <p>④x1</p>
 <p>⑤x1</p>	 <p>⑥x1</p>	 <p>⑦x1</p>	 <p>⑧x1</p>
 <p>⑨x2</p>	 <p>⑩x2</p>	 <p>⑪x2</p>	 <p>⑫x2</p>
 <p>⑬x1</p>	 <p>⑭x1</p>	 <p>⑮x1</p>	 <p>⑯x1</p>

BOARD IDENTIFICATION

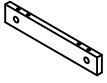

⑰x1

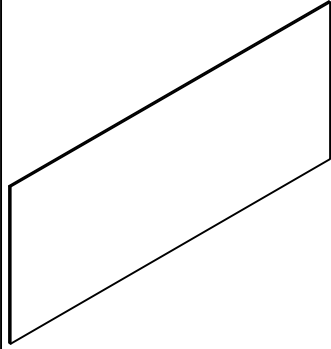

⑱x1

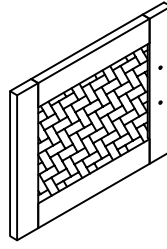

⑲x2













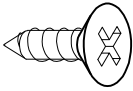
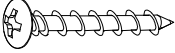
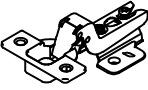

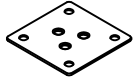
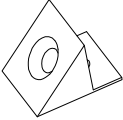
⑳x4

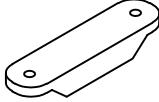
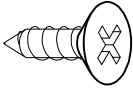
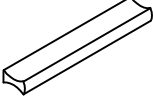

㉑x2



BOARD IDENTIFICATION

<p>A</p>  <p>$\phi 6 \times 32\text{mm}$ 20+2pcs</p>	<p>B</p>  <p>$\phi 15 \times 9.5\text{mm}$ 20+2pcs</p>	<p>C</p>  <p>$\phi 8 \times 30\text{mm}$ 22+2pcs</p>	<p>D</p>  <p>$M3.5 \times 14\text{mm}$ 72+2pcs</p>
<p>E</p>  <p>$M4 \times 35\text{mm}$ 18+2pcs</p>	<p>F</p>  <p>4pcs</p>	<p>G</p>  <p>$M6 \times 15\text{mm}$ 6pcs</p>	<p>H</p>  <p>6pcs</p>
<p>I</p>  <p>12+2pcs</p>	<p>J</p>  <p>$M3.0 \times 14\text{mm}$ 12+2pcs</p>	<p>K</p>  <p>1pcs</p>	<p>L</p>  <p>$M3.0 \times 12\text{mm}$ 2+1pcs</p>
<p>M</p>  <p>4pcs</p>	<p>N</p>  <p>$M4 \times 18\text{mm}$ 8+1pcs</p>	<p>O</p>  <p>$M4 \times 25\text{mm}$ 18+2pcs</p>	<p>CL</p>  <p>250mm 2pcs</p>
<p>CR</p>  <p>250mm 2pcs</p>	<p>DL</p>  <p>250mm 2pcs</p>	<p>DR</p>  <p>250mm 2pcs</p>	

INSTALLATION STEPS

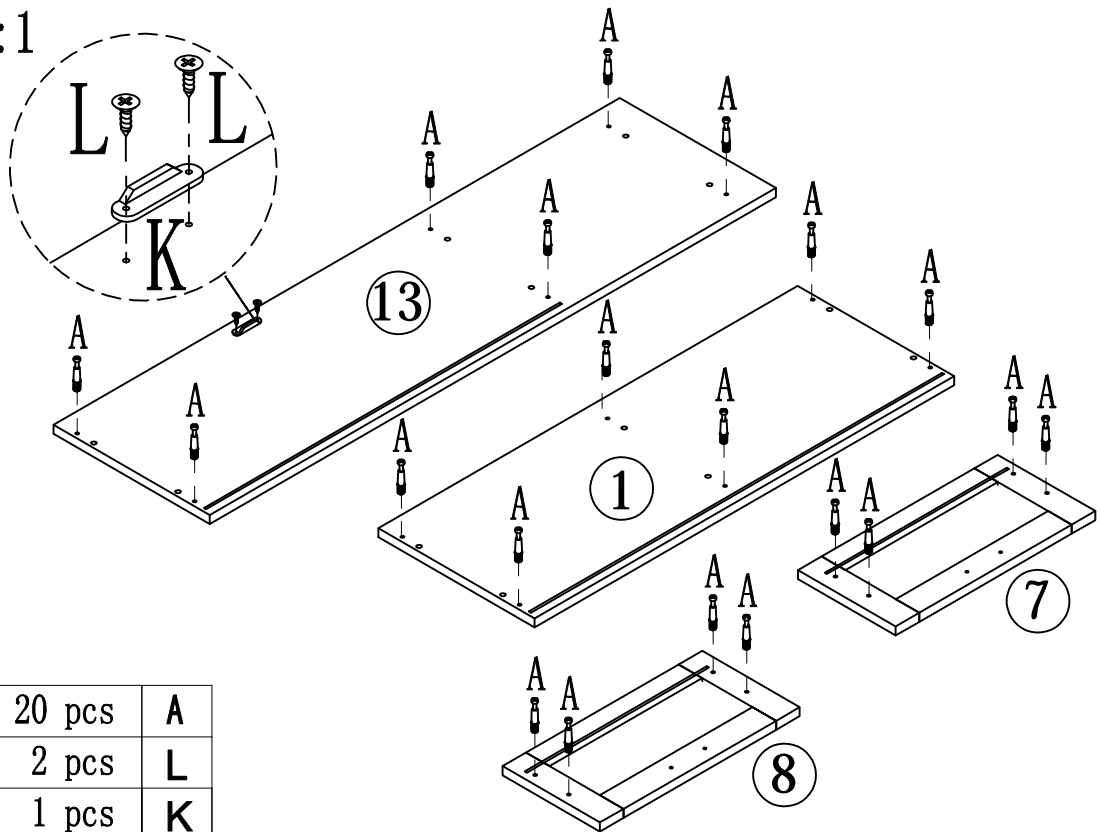
Step:1



	20 pcs	A
	2 pcs	L
	1 pcs	K

Step:2

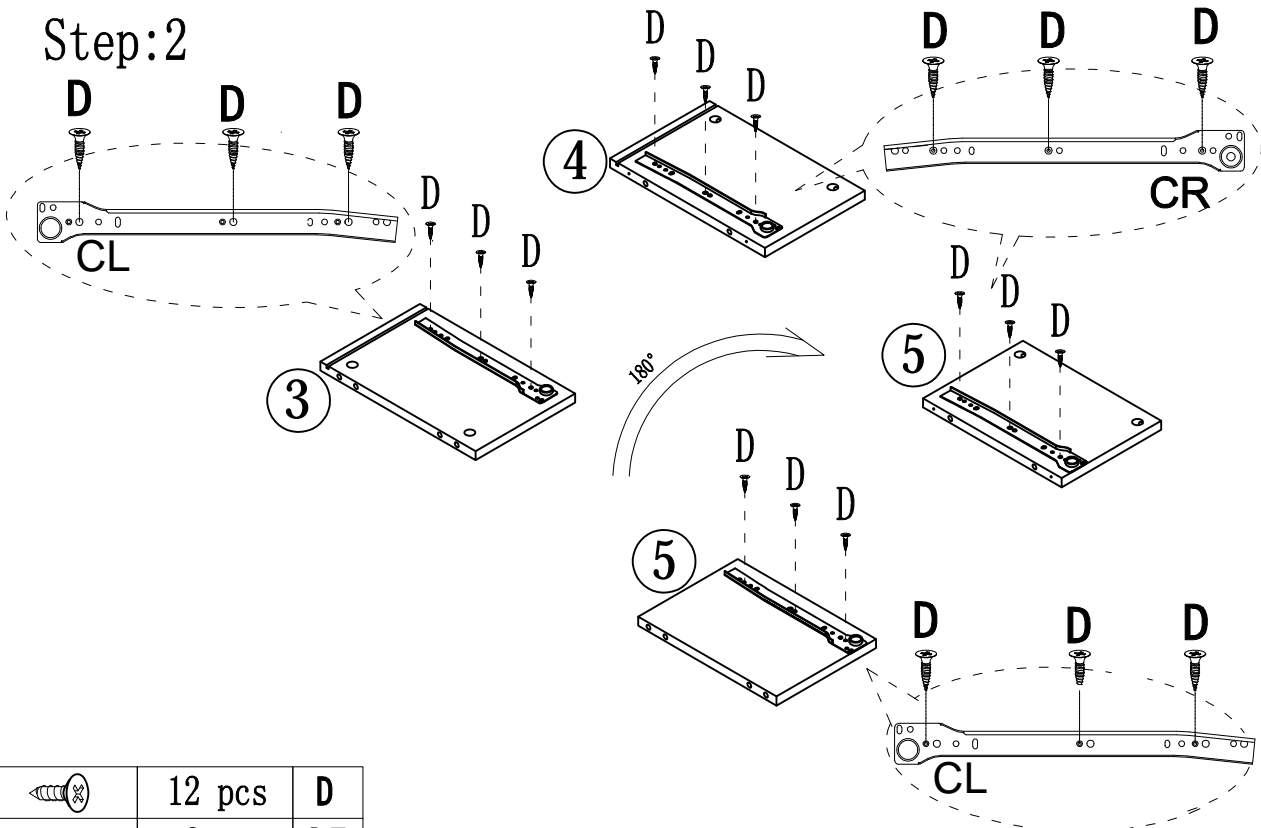

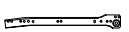
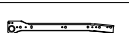

	12 pcs	D
	2 pcs	CR
	2 pcs	CL

INSTALLATION STEPS

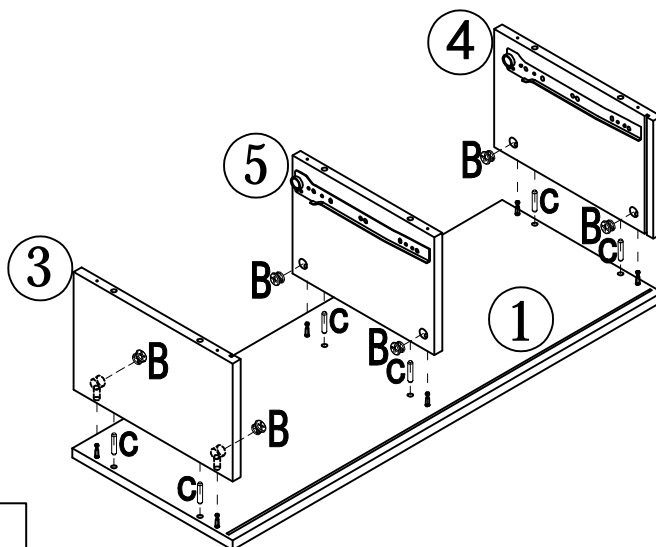
Step:3



	6 pcs	B
	6 pcs	C

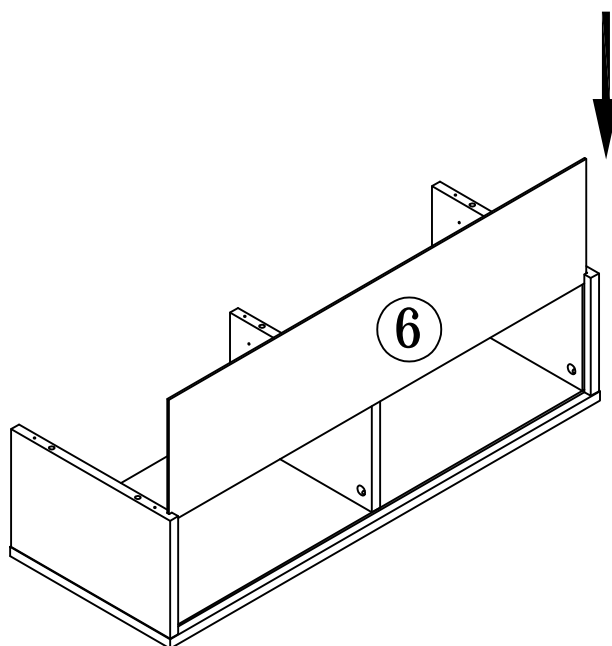

Step:4



INSTALLATION STEPS

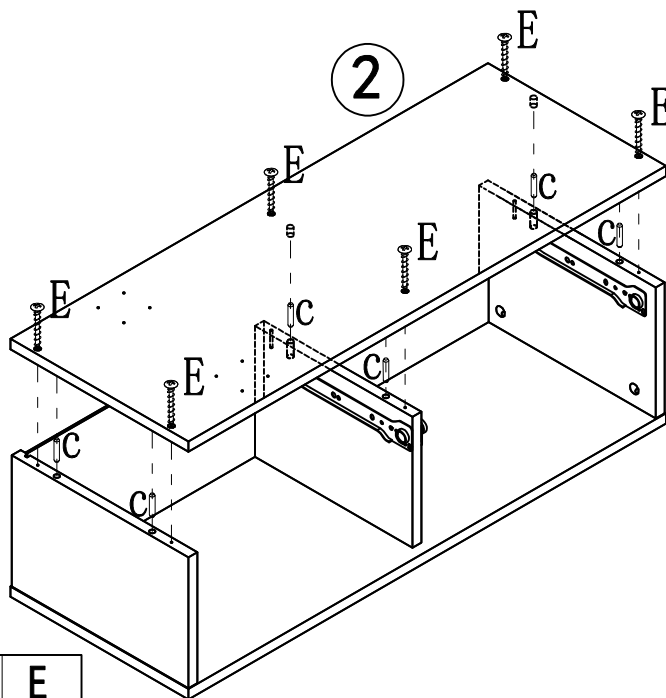

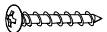

Step:5

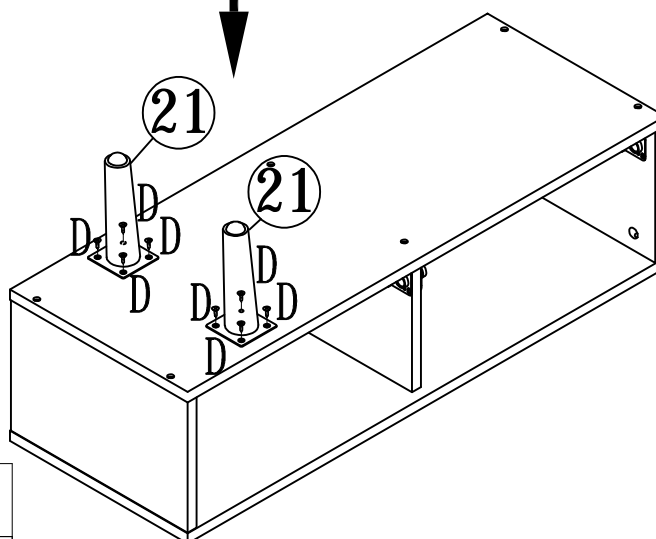
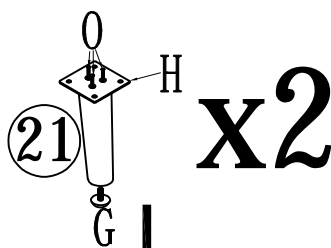

	6 pcs	E
	6 pcs	C

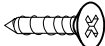
Step:6





	6 pcs	O
	2 pcs	H
	2 pcs	G
	8 pcs	D

INSTALLATION STEPS

Step:7

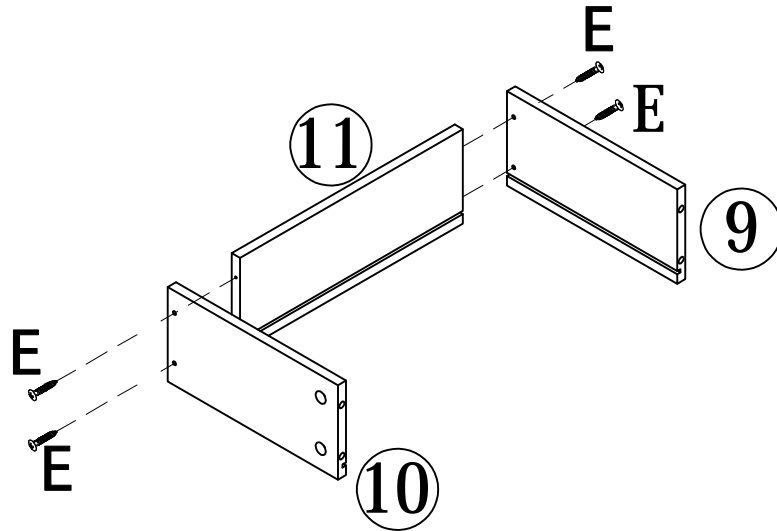
x2



	8 pcs	E
--	-------	---

Step:8

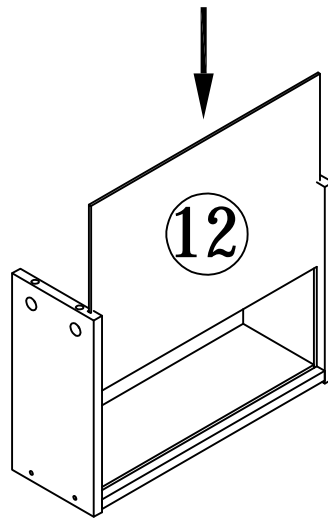

x2

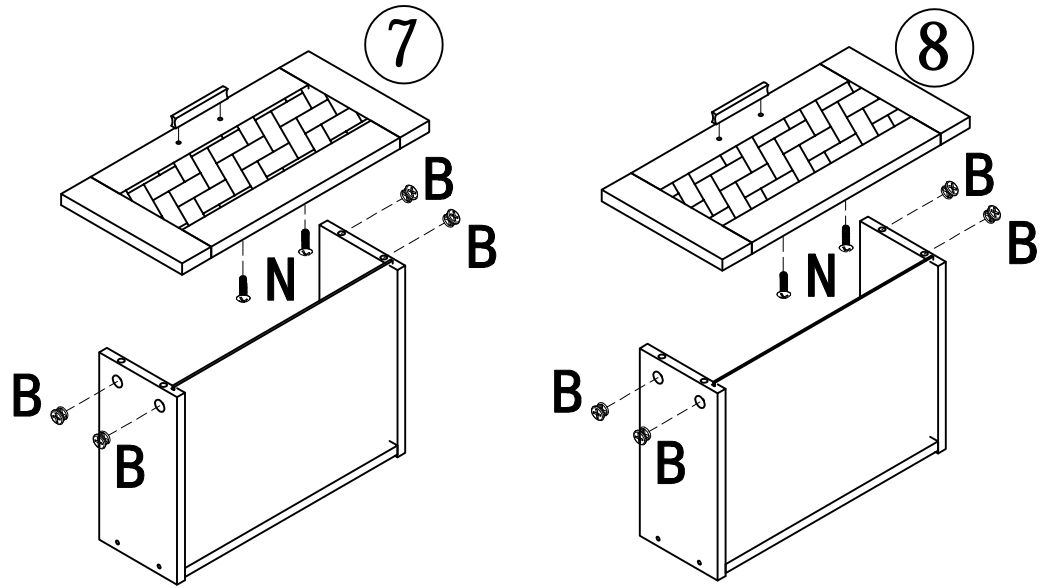

INSTALLATION STEPS

Step:9



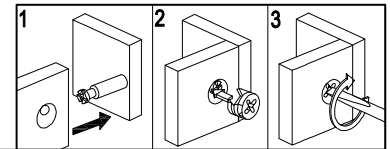

	8 pcs	B
	2 pcs	M
	4 pcs	N

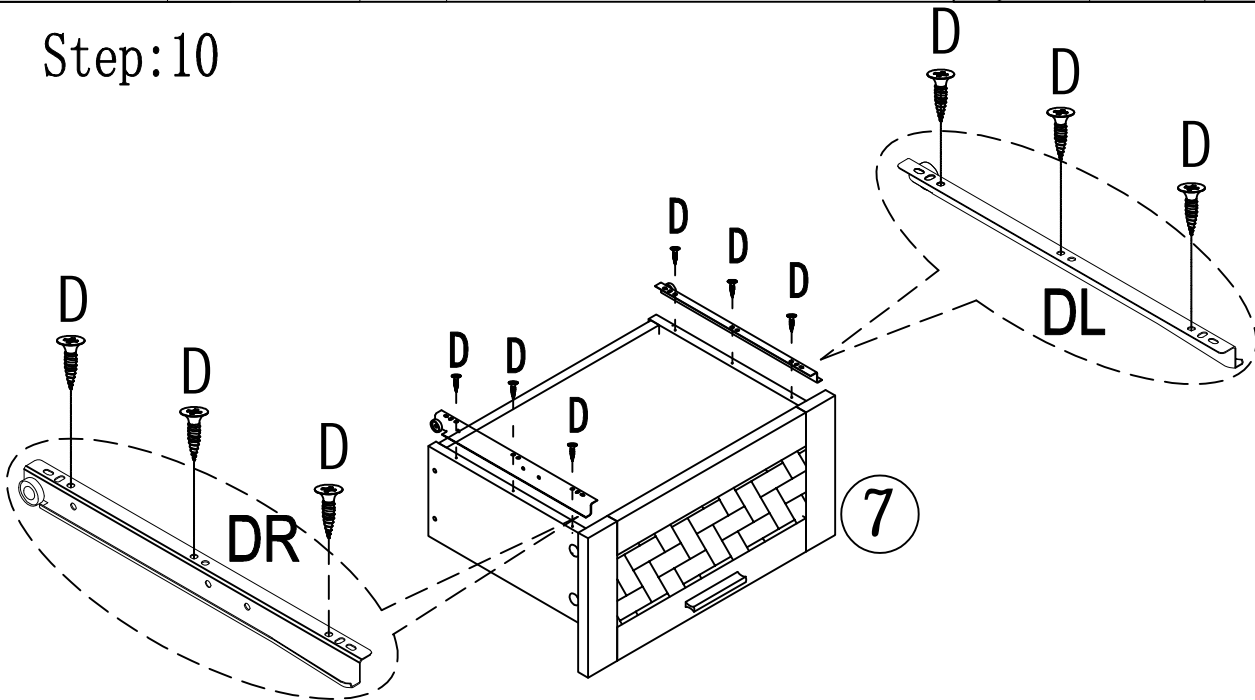

Step:10





	6 pcs	D
	1 pcs	DL
	1 pcs	DR

INSTALLATION STEPS

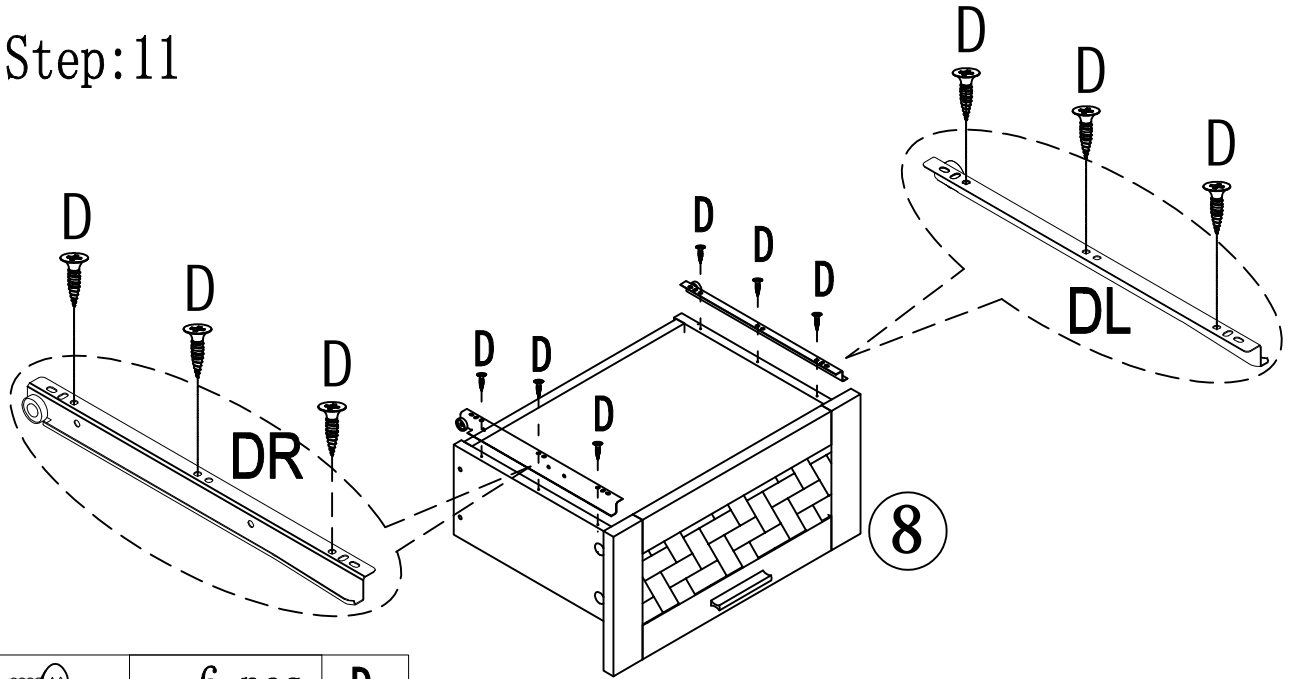



Step:11

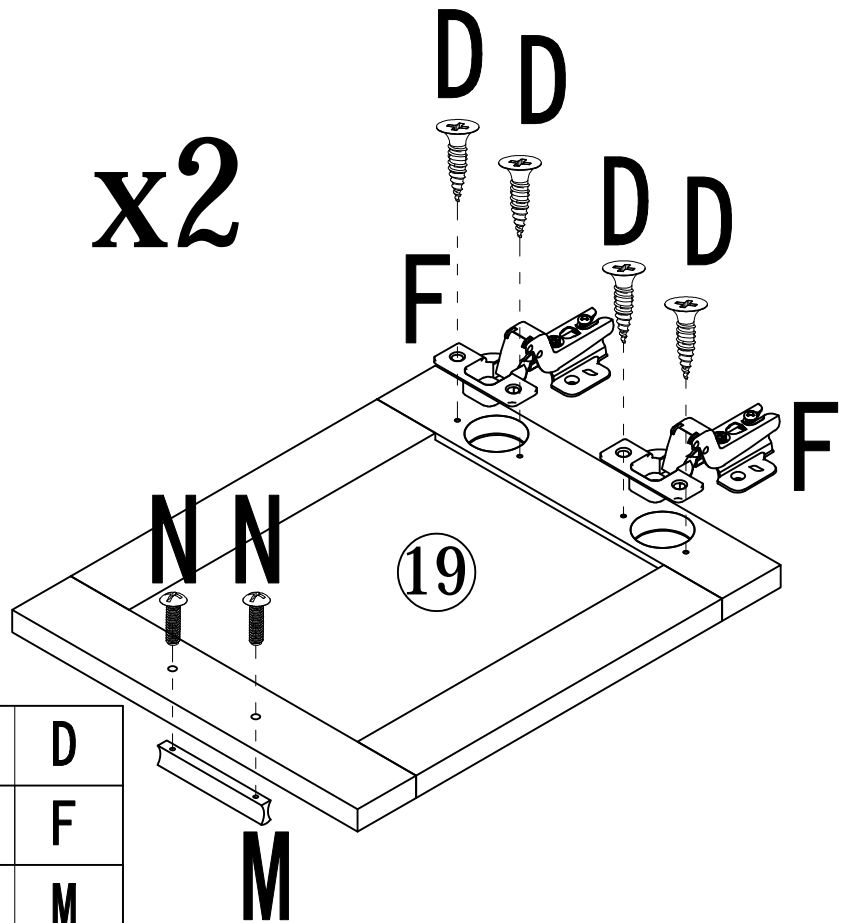

	6 pcs	D
	1 pcs	DL
	1 pcs	DR

Step:12





	8 pcs	D
	4 pcs	F
	2 pcs	M
	4 pcs	N

INSTALLATION STEPS

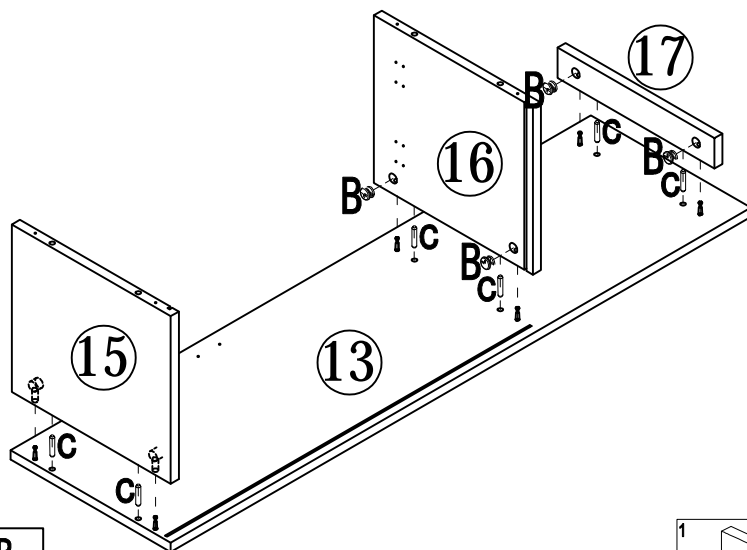
Step:13



	6 pcs	B
	6 pcs	C

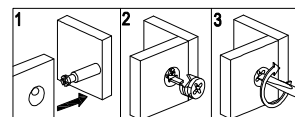

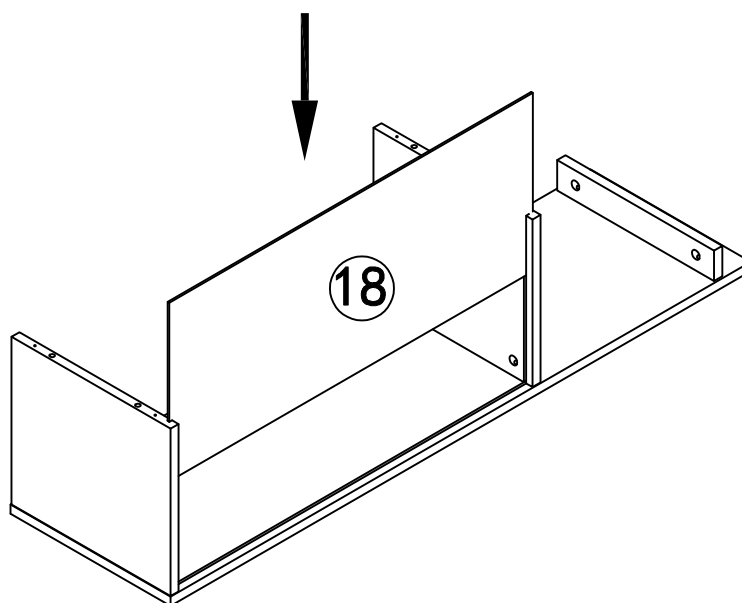

Step:14



INSTALLATION STEPS

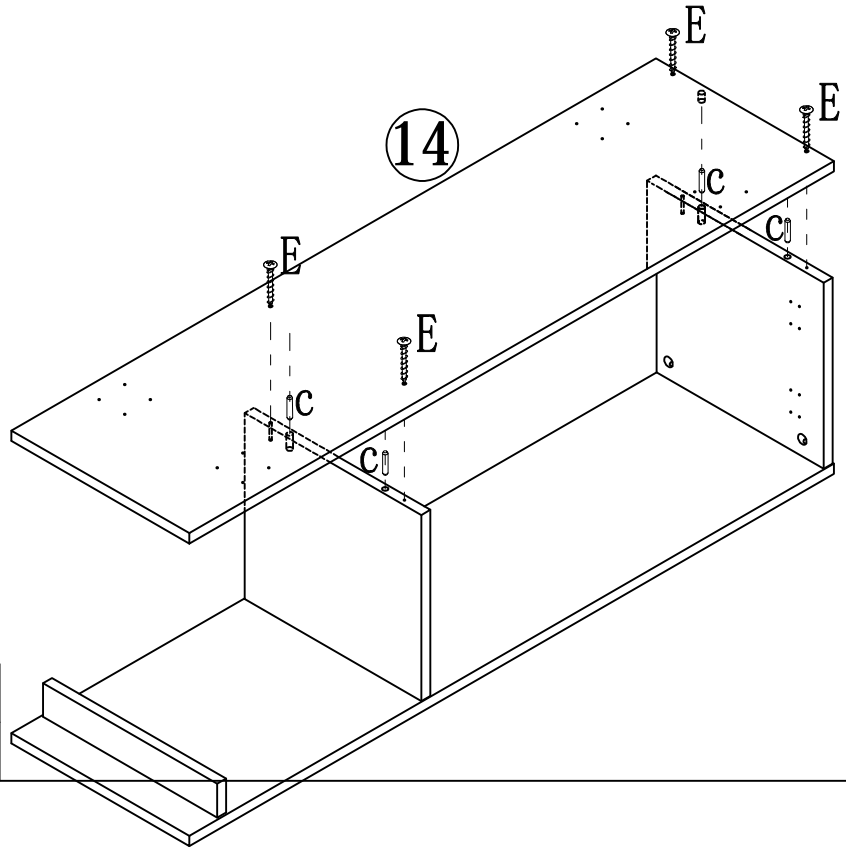

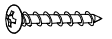

Step:15

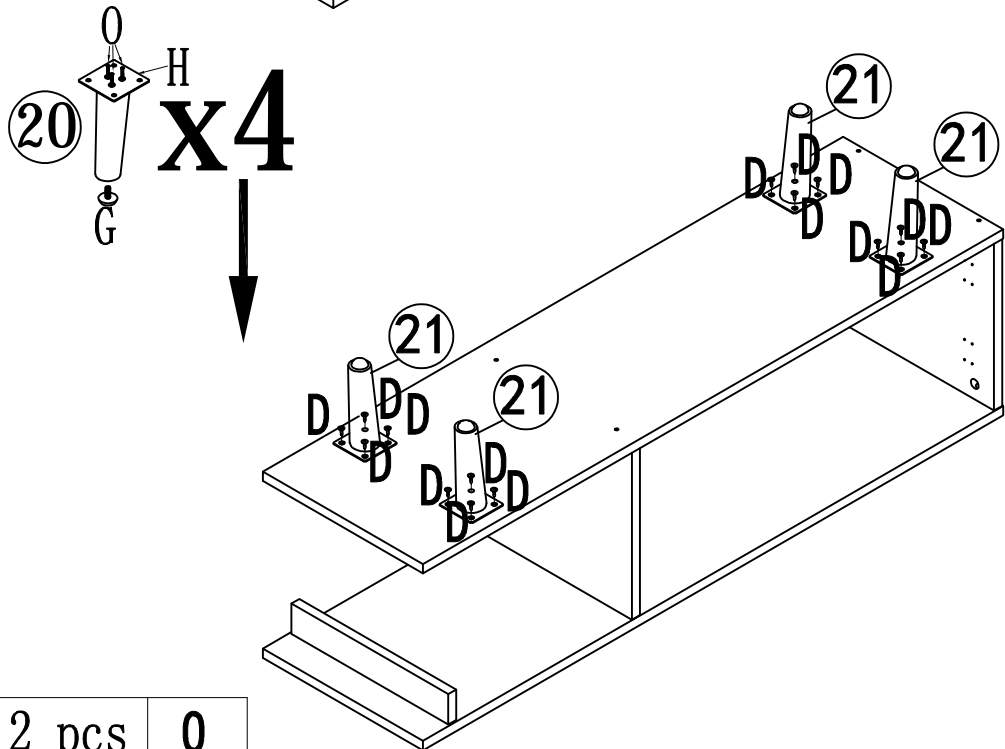

	4 pcs	E
	4 pcs	C

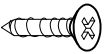
Step:16



	12 pcs	O
	4 pcs	H
	4 pcs	G
	16 pcs	D

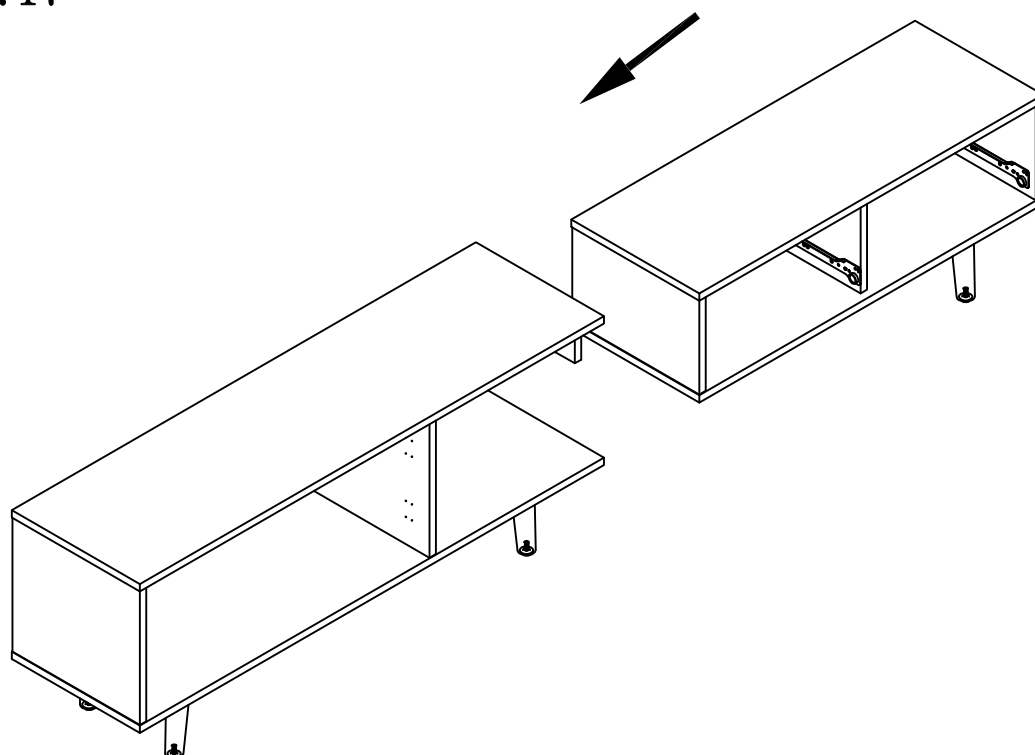

INSTALLATION STEPS

Step:17

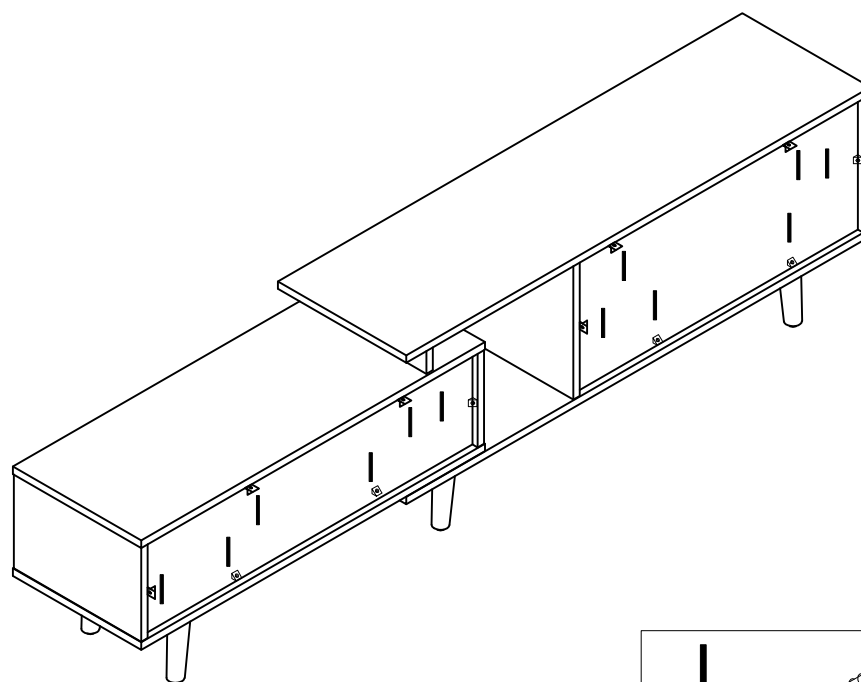

Step:18



	12 pcs	I
	12 pcs	J

14

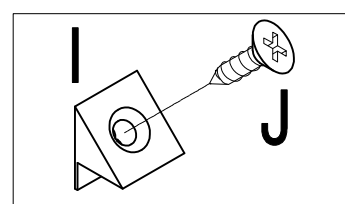

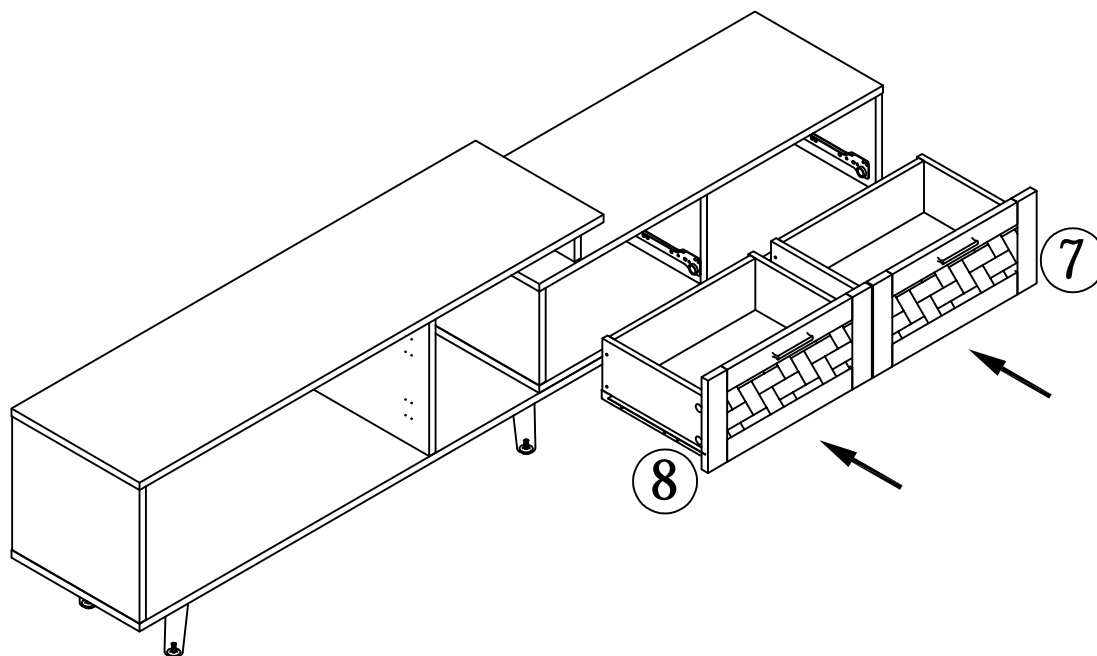

INSTALLATION STEPS

Step:19

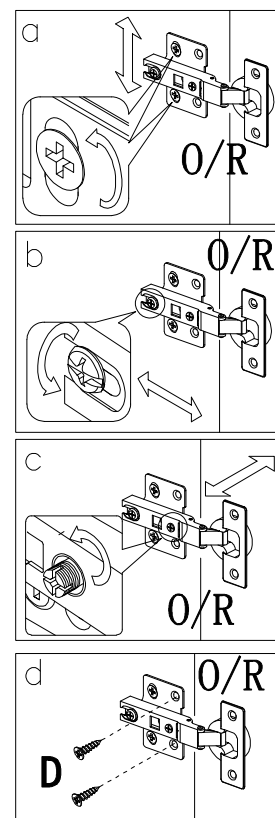
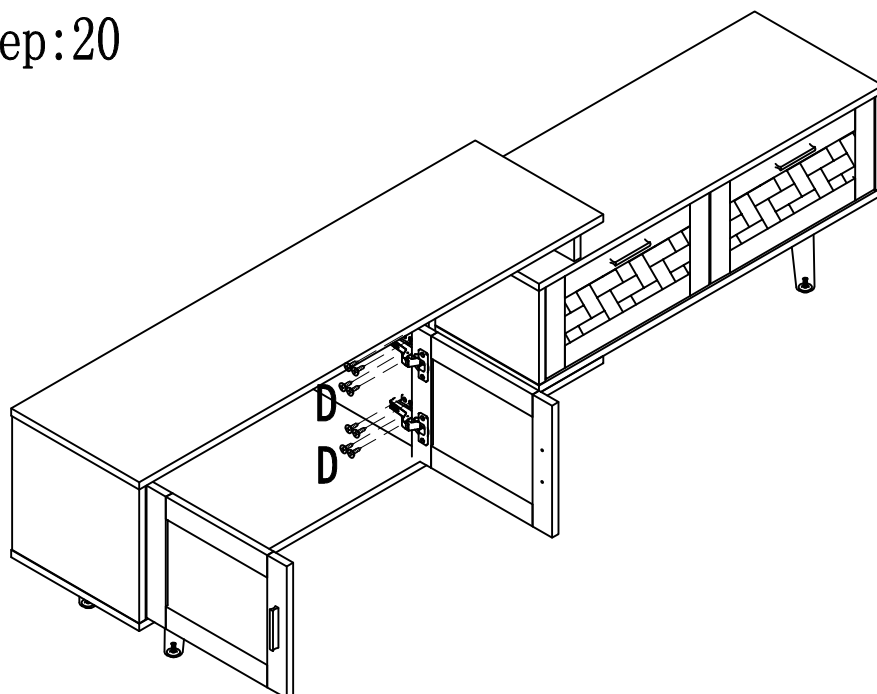

Step:20



	16 pcs	D
---	--------	---

15

Step:21

